

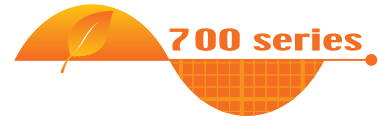

**MITSUBISHI
ELECTRIC**



INVERTER FR-E700

INSTRUCTION MANUAL (Applied)

CC-Link communication function

FR-E720-0.1KNC to 15KNC

FR-E740-0.4KNC to 15KNC

FR-E720S-0.1KNC to 2.2KNC

OUTLINE

1

WIRING

2

**PRECAUTIONS FOR USE
OF THE INVERTER**

3

**CC-LINK COMMUNICATION
FUNCTION**

4

PARAMETERS

5

TROUBLESHOOTING

6

**PRECAUTIONS FOR
MAINTENANCE AND INSPECTION**

7

SPECIFICATIONS

8

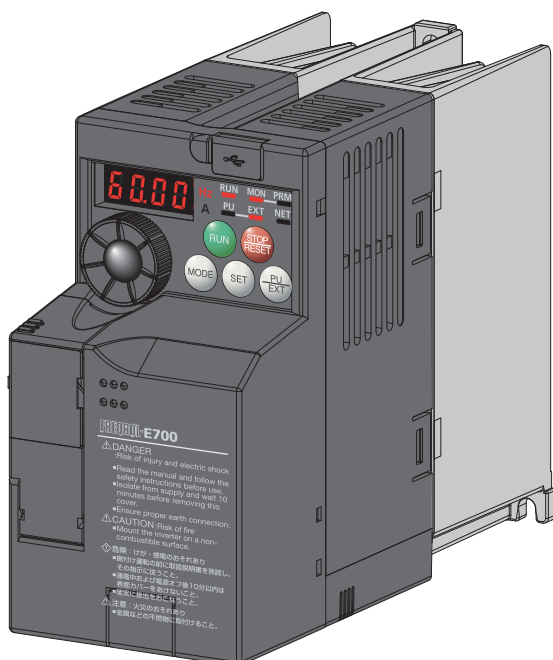

Thank you for choosing this Mitsubishi Inverter.

This Instruction Manual (Applied) provides instructions for advanced use of the FR-E700 series CC-Link type inverters. Incorrect handling might cause an unexpected fault. Before using the inverter, always read this Instruction Manual and the Instruction Manual (Basic) [IB-0600401ENG] packed with the product carefully to use the equipment to its optimum performance.

This section is specifically about safety matters

Do not attempt to install, operate, maintain or inspect the inverter until you have read through the Instruction Manual and appended documents carefully and can use the equipment correctly. Do not use this product until you have a full knowledge of the equipment, safety information and instructions.
In this Instruction Manual, the safety instruction levels are classified into "WARNING" and "CAUTION".

⚠ WARNING Incorrect handling may cause hazardous conditions, resulting in death or severe injury.

⚠ CAUTION Incorrect handling may cause hazardous conditions, resulting in medium or slight injury, or may cause only material damage.

The **⚠ CAUTION** level may even lead to a serious consequence according to conditions. Both instruction levels must be followed because these are important to personal safety.

1. Electric Shock Prevention

⚠ WARNING

- While power is ON or when the inverter is running, do not open the front cover. Otherwise you may get an electric shock.
- Do not run the inverter with the front cover or wiring cover removed. Otherwise you may access the exposed high-voltage terminals or the charging part of the circuitry and get an electric shock.
- Even if power is OFF, do not remove the front cover except for wiring or periodic inspection. You may accidentally touch the charged inverter circuits and get an electric shock.
- Before wiring or inspection, power must be switched OFF. To confirm that, LED indication of the operation panel must be checked. (It must be OFF.) Any person who is involved in wiring or inspection shall wait for at least 10 minutes after the power supply has been switched OFF and check that there are no residual voltage using a tester or the like. The capacitor is charged with high voltage for some time after power OFF, and it is dangerous.
- This inverter must be earthed (grounded). Earthing (grounding) must conform to the requirements of national and local safety regulations and electrical code (NEC section 250, IEC 536 class 1 and other applicable standards). A neutral-point earthed (grounded) power supply for 400V class inverter in compliance with EN standard must be used.
- Any person who is involved in wiring or inspection of this equipment shall be fully competent to do the work.
- The inverter must be installed before wiring. Otherwise you may get an electric shock or be injured.
- Setting dial and key operations must be performed with dry hands to prevent an electric shock.
- Do not subject the cables to scratches, excessive stress, heavy loads or pinching. Otherwise you may get an electric shock.
- Do not change the cooling fan while power is ON. It is dangerous to change the cooling fan while power is ON.
- Do not touch the printed circuit board or handle the cables with wet hands. Otherwise you may get an electric shock.
- When measuring the main circuit capacitor capacity, the DC voltage is applied to the motor for 1s at powering OFF. Never touch the motor terminal, etc. right after powering OFF to prevent an electric shock.

2. Fire Prevention

⚠ CAUTION

- Inverter must be installed on a nonflammable wall without holes (so that nobody touches the inverter heatsink on the rear side, etc.). Mounting it to or near flammable material can cause a fire.
- If the inverter has become faulty, the inverter power must be switched OFF. A continuous flow of large current could cause a fire.
- When using a brake resistor, a sequence that will turn OFF power when a fault signal is output must be configured. Otherwise the brake resistor may overheat due to damage of the brake transistor and possibly cause a fire.
- Do not connect a resistor directly to the DC terminals P/+ and N/-. Doing so could cause a fire.

3. Injury Prevention

⚠ CAUTION

- The voltage applied to each terminal must be the ones specified in the Instruction Manual. Otherwise burst, damage, etc. may occur.
- The cables must be connected to the correct terminals. Otherwise burst, damage, etc. may occur.
- Polarity must be correct. Otherwise burst, damage, etc. may occur.
- While power is ON or for some time after power-OFF, do not touch the inverter as they will be extremely hot. Doing so can cause burns.

4. Additional Instructions

Also the following points must be noted to prevent an accidental failure, injury, electric shock, etc.

(1) Transportation and Mounting

⚠ CAUTION

- The product must be transported in correct method that corresponds to the weight. Failure to do so may lead to injuries.
- Do not stack the boxes containing inverters higher than the number recommended.
- The product must be installed to the position where withstands the weight of the product according to the information in the Instruction Manual.
- Do not install or operate the inverter if it is damaged or has parts missing.
- When carrying the inverter, do not hold it by the front cover or setting dial; it may fall off or fail.
- Do not stand or rest heavy objects on the product.
- The inverter mounting orientation must be correct.
- Foreign conductive objects must be prevented from entering the inverter. That includes screws and metal fragments or other flammable substance such as oil.
- As the inverter is a precision instrument, do not drop or subject it to impact.
- The inverter must be used under the following environment. Otherwise the inverter may be damaged.

Environment	Surrounding air temperature	-10°C to +50°C (non-freezing)
	Ambient humidity	90%RH or less (non-condensing)
	Storage temperature	-20°C to +65°C *1
	Atmosphere	Indoors (free from corrosive gas, flammable gas, oil mist, dust and dirt)
	Altitude/vibration	Maximum 1,000m above sea level. 5.9m/s ² or less at 10 to 55Hz (directions of X, Y, Z axes)

*1 Temperature applicable for a short time, e.g. in transit.

(2) Wiring

⚠ CAUTION

- Do not install a power factor correction capacitor or surge suppressor/capacitor type filter on the inverter output side. These devices on the inverter output side may be overheated or burn out.
- The connection orientation of the output cables U, V, W to the motor affects the rotation direction of the motor.

(3) Trial run

⚠ CAUTION

- Before starting operation, each parameter must be confirmed and adjusted. A failure to do so may cause some machines to make unexpected motions.

(4) Usage

⚠ WARNING

- Any person must stay away from the equipment when the retry function is set as it will restart suddenly after trip.
- Since pressing  key may not stop output depending on the function setting status, separate circuit and switch that make an emergency stop (power OFF, mechanical brake operation for emergency stop, etc.) must be provided.
- OFF status of the start signal must be confirmed before resetting the inverter fault. Resetting inverter alarm with the start signal ON restarts the motor suddenly.
- The inverter must be used for three-phase induction motors. Connection of any other electrical equipment to the inverter output may damage the equipment.
- Do not modify the equipment.
- Do not perform parts removal which is not instructed in this manual. Doing so may lead to fault or damage of the product.

⚠ CAUTION

- The electronic thermal relay function does not guarantee protection of the motor from overheating. It is recommended to install both an external thermal for overheat protection.
- Do not use a magnetic contactor on the inverter input for frequent starting/stopping of the inverter. Otherwise the life of the inverter decreases.
- The effect of electromagnetic interference must be reduced by using a noise filter or by other means. Otherwise nearby electronic equipment may be affected.
- Appropriate measures must be taken to suppress harmonics. Otherwise power supply harmonics from the inverter may heat/damage the power factor correction capacitor and generator.
- When driving a 400V class motor by the inverter, the motor must be an insulation-enhanced motor or measures must be taken to suppress surge voltage. Surge voltage attributable to the wiring constants may occur at the motor terminals, deteriorating the insulation of the motor.
- When parameter clear or all parameter clear is performed, the required parameters must be set again before starting operations because all parameters return to the initial value.
- The inverter can be easily set for high-speed operation. Before changing its setting, the performances of the motor and machine must be fully examined.
- Stop status cannot be hold by the inverter's brake function. In addition to the inverter's brake function, a holding device must be installed to ensure safety.
- Before running an inverter which had been stored for a long period, inspection and test operation must be performed.
- For prevention of damage due to static electricity, nearby metal must be touched before touching this product to eliminate static electricity from your body.
- If you are installing the inverter to drive a three-phase device while you are contracted for lighting and power service, consult your electric power supplier.

(5) Emergency stop

⚠ CAUTION

- A safety backup such as an emergency brake must be provided to prevent hazardous condition to the machine and equipment in case of inverter failure.
- When the breaker on the inverter input side trips, the wiring must be checked for fault (short circuit), and internal parts of the inverter for a damage, etc. The cause of the trip must be identified and removed before turning ON the power of the breaker.
- When any protective function is activated, appropriate corrective action must be taken, and the inverter must be reset before resuming operation.

(6) Maintenance, inspection and parts replacement

⚠ CAUTION

- Do not carry out a megger (insulation resistance) test on the control circuit of the inverter. It will cause a failure.

(7) Disposal

⚠ CAUTION

- The inverter must be treated as industrial waste.

General instruction

Many of the diagrams and drawings in this Instruction Manual show the inverter without a cover or partially open for explanation. Never operate the inverter in this manner. The cover must be always reinstalled and the instruction in this Instruction Manual must be followed when operating the inverter.

Harmonic suppression guideline (when inverters are used in Japan)

All models of general-purpose inverters used by specific consumers are covered by "Harmonic suppression guideline for consumers who receive high voltage or special high voltage". (For further details, refer to page 37.)

CONTENTS

1	OUTLINE	1
1.1	Product checking and parts identification	2
1.2	Inverter and peripheral devices	3
1.2.1	Peripheral devices	4
1.3	Removal and reinstallation of the cover	5
1.3.1	Front cover	5
1.3.2	Wiring cover	7
1.4	Installation of the inverter and enclosure design	8
1.4.1	Inverter installation environment	8
1.4.2	Cooling system types for inverter enclosure	10
1.4.3	Inverter placement	11
2	WIRING	13
2.1	Wiring	14
2.1.1	Terminal connection diagram	14
2.2	Main circuit terminal specifications	15
2.2.1	Specification of main circuit terminal	15
2.2.2	Terminal arrangement of the main circuit terminal, power supply and the motor wiring	15
2.2.3	Cables and wiring length	17
2.3	Control circuit specifications	20
2.3.1	Control circuit terminal	20
2.3.2	Wiring of control circuit	21
2.3.3	Connecting the 24V external power supply	23
2.3.4	Safety stop function	24
2.4	Connection of stand-alone option unit	26
2.4.1	Connection of a dedicated external brake resistor (MRS type, MYS type, FR-ABR) (0.4K or higher)	26
2.4.2	Connection of the brake unit (FR-BU2)	28
2.4.3	Connection of the DC reactor (FR-HEL)	29
3	PRECAUTIONS FOR USE OF THE INVERTER	31
3.1	EMC and leakage currents	32
3.1.1	Leakage currents and countermeasures	32
3.1.2	EMC measures	34
3.1.3	Power supply harmonics	36
3.1.4	Harmonic Suppression Guidelines in Japan	37

3.2	Installation of power factor improving reactor.....	39
3.3	Power-OFF and magnetic contactor (MC)	40
3.4	Inverter-driven 400V class motor	41
3.5	Precautions for use of the inverter	42
3.6	Failsafe of the system which uses the inverter.....	44
4	CC-LINK COMMUNICATION FUNCTION	47
<hr/>		
4.1	CC-Link communication specifications.....	48
4.2	CC-Link version	48
4.2.1	CC-Link Ver. 1.10	48
4.2.2	CC-Link Ver. 2	48
4.3	Wiring for CC-Link communication	49
4.3.1	System configuration example.....	49
4.3.2	Connection of several inverters	50
4.3.3	Connection cable and plug	51
4.3.4	Connection of CC-Link dedicated cable	52
4.3.5	Unit replacement while online.....	53
4.4	Function overview.....	54
4.4.1	Function block diagram.....	54
4.4.2	Output from the inverter to the network	55
4.4.3	Input to the inverter from the network.....	55
4.5	I/O signal list	56
4.5.1	I/O signals when CC-Link Ver. 1 one station (FR-E500 series compatible) is occupied (Pr. 544 = "0")	56
4.5.2	I/O signals when CC-Link Ver. 1 one station is occupied (Pr. 544 = "1")	57
4.5.3	I/O signals when CC-Link Ver. 2 double setting is selected (Pr. 544 = "12").....	57
4.5.4	I/O signals when CC-Link Ver. 2 quadruple setting is selected (Pr. 544 = "14")	58
4.5.5	I/O signals when CC-Link Ver. 2 octuple setting is selected (Pr. 544 = "18").....	59
4.6	Details of I/O signals	60
4.6.1	Details of remote I/O signals.....	60
4.6.2	Details of remote registers.....	62
4.7	Programming examples	67
4.7.1	Programming example for reading the inverter status.....	69
4.7.2	Programming example for setting the operation mode.....	69
4.7.3	Programming example for setting the operation commands	70
4.7.4	Programming example for monitoring the output frequency.....	70
4.7.5	Programming example for parameter reading	71

4.7.6	Programming example for parameter writing	71
4.7.7	Programming example for setting the running frequency	72
4.7.8	Programming example for fault record reading	73
4.7.9	Programming example for resetting the inverter at inverter error	73
4.7.10	Instructions	74
4.8	How to check for error using the LEDs.....	75
4.8.1	Operation status indication LEDs	75
4.8.2	When one inverter is connected	75
4.8.3	When two or more inverters are connected.....	76
4.8.4	Communication stops during operation	77

5 PARAMETERS **79**

5.1	Operation panel	80
5.1.1	Names and functions of the operation panel	80
5.1.2	Basic operation (factory setting)	81
5.1.3	Changing the parameter setting value.....	82
5.1.4	Setting dial push	83
5.2	Parameter list	84
5.2.1	Parameter list	84
5.3	Selection of operation mode	103
5.3.1	Operation mode selection (Pr. 79).....	103
5.4	Operation via CC-Link communication and its settings.....	105
5.4.1	CC-Link communication setting (Pr.541 to Pr.544)	105
5.4.2	Operation selection at CC-Link communication error occurrence (Pr. 500 to Pr. 502)	107
5.4.3	CC-Link communication reset selection (Pr.349)	110
5.4.4	Communication EEPROM write selection (Pr. 342)	110
5.5	Control mode	111
5.5.1	Changing the control method (Pr. 80, Pr. 81, Pr. 800)	112
5.6	Adjustment of the output torque (current) of the motor	113
5.6.1	Manual torque boost (Pr. 0, Pr. 46)	113
5.6.2	Advanced magnetic flux vector control (Pr. 71, Pr. 80, Pr. 81, Pr.89, Pr. 800)	114
5.6.3	General-purpose magnetic flux vector control (Pr. 71, Pr. 80, Pr. 81, Pr. 800)	117
5.6.4	Slip compensation (Pr. 245 to Pr. 247)	119
5.6.5	Stall prevention operation (Pr. 22, Pr. 23, Pr. 48, Pr. 66, Pr. 156, Pr. 157, Pr. 277)	120
5.7	Limiting the output frequency.....	124
5.7.1	Maximum/minimum frequency (Pr. 1, Pr. 2, Pr. 18)	124
5.7.2	Avoiding mechanical resonance points (frequency jumps) (Pr. 31 to Pr. 36).....	125
5.8	V/F pattern	126

5.8.1	Base frequency, voltage (Pr. 3, Pr. 19, Pr. 47).....	126
5.8.2	Load pattern selection (Pr. 14).....	128
5.9	Frequency setting with input signals	130
5.9.1	Operation by multi-speed operation (Pr. 4 to Pr. 6, Pr. 24 to Pr. 27, Pr. 232 to Pr. 239).....	130
5.9.2	Remote setting function (Pr. 59).....	132
5.10	Setting of acceleration/deceleration time and acceleration/ deceleration pattern	135
5.10.1	Setting of the acceleration and deceleration time (Pr. 7, Pr. 8, Pr. 20, Pr. 21, Pr. 44, Pr. 45, Pr. 147).....	135
5.10.2	Starting frequency and start-time hold function (Pr. 13, Pr. 571).....	138
5.10.3	Acceleration/deceleration pattern (Pr. 29).....	139
5.10.4	Shortest acceleration/deceleration (automatic acceleration/deceleration) (Pr. 61 to Pr. 63, Pr. 292, Pr. 293).....	140
5.11	Selection and protection of a motor	142
5.11.1	Motor overheat protection (Electronic thermal O/L relay) (Pr. 9, Pr. 51).....	142
5.11.2	Applied motor (Pr. 71, Pr. 450).....	144
5.11.3	Exhibiting the best performance for the motor (offline auto tuning) (Pr. 71, Pr. 80 to Pr. 84, Pr. 90 to Pr. 94, Pr. 96, Pr. 859).....	146
5.12	Motor brake and stop operation	154
5.12.1	DC injection brake (Pr. 10 to Pr. 12).....	154
5.12.2	Selection of a regenerative brake (Pr. 30, Pr. 70).....	155
5.12.3	Stop selection (Pr. 250).....	157
5.12.4	Stop-on contact control function (Pr. 6, Pr. 48, Pr. 270, Pr. 275, Pr. 276).....	158
5.12.5	Brake sequence function (Pr. 278 to Pr. 283, Pr. 292).....	160
5.13	Function assignment of external terminals and CC-Link communication virtual terminals	163
5.13.1	Input terminal function selection (Pr. 180 to Pr. 184).....	163
5.13.2	Inverter output shutoff signal (MRS signal, Pr. 17).....	166
5.13.3	Output terminal function selection (Pr. 190 to Pr. 192, Pr. 313 to Pr. 315).....	167
5.13.4	Detection of output frequency (SU, FU signal, Pr. 41 to Pr. 43).....	171
5.13.5	Output current detection function (Y12 signal, Y13 signal, Pr. 150 to Pr. 153).....	172
5.13.6	Remote output selection (REM signal, Pr. 495, Pr. 496).....	174
5.14	Monitor display and monitor output signal	175
5.14.1	Speed display and speed setting (Pr. 37).....	175
5.14.2	Monitor display selection of operation panel (Pr. 52, Pr. 170, Pr. 171, Pr. 268, Pr. 563, Pr. 564).....	176
5.15	Operation selection at power failure and instantaneous power failure	180
5.15.1	Automatic restart after instantaneous power failure/flying start (Pr. 57, Pr. 58, Pr. 96, Pr. 162, Pr. 165, Pr. 298, Pr. 299, Pr. 611).....	180
5.15.2	Power-failure deceleration stop function (Pr. 261).....	186

5.16 Operation setting at fault occurrence	188
5.16.1 Retry function (Pr. 65, Pr. 67 to Pr. 69)	188
5.16.2 Input/output phase loss protection selection (Pr. 251, Pr. 872).....	190
5.16.3 Earth (ground) fault detection at start (Pr. 249).....	190
5.17 Energy saving operation.....	191
5.17.1 Optimum excitation control (Pr. 60).....	191
5.18 Motor noise, EMI measures, mechanical resonance	192
5.18.1 PWM carrier frequency and soft-PWM control (Pr. 72, Pr. 240).....	192
5.18.2 Speed smoothing control (Pr. 653).....	193
5.19 Misoperation prevention and parameter setting restriction.....	194
5.19.1 Reset selection/PU stop selection (Pr. 75).....	194
5.19.2 Parameter write disable selection (Pr. 77).....	196
5.19.3 Reverse rotation prevention selection (Pr. 78)	197
5.19.4 Extended parameter display and user group function (Pr. 160, Pr. 172 to Pr. 174).....	197
5.19.5 Password function (Pr. 296, Pr. 297).....	199
5.20 Special operation and frequency control	201
5.20.1 JOG operation (Pr. 15, Pr. 16).....	201
5.20.2 PID control (Pr. 125, Pr. 127 to Pr. 132, Pr. 134, C2)	203
5.20.3 Droop control (Pr. 286, Pr. 287)	210
5.20.4 Regeneration avoidance function (Pr. 665, Pr. 882, Pr. 883, Pr. 885, Pr. 886).....	211
5.21 Useful functions	213
5.21.1 Cooling fan operation selection (Pr. 244)	213
5.21.2 Display of the life of the inverter parts (Pr. 255 to Pr. 259).....	214
5.21.3 Maintenance timer alarm (Pr. 503, Pr. 504)	217
5.21.4 Average current monitor signal (Pr. 555 to Pr. 557)	218
5.21.5 USB communication (Pr. 547, Pr. 548, Pr. 551).....	220
5.21.6 Free parameter (Pr. 888, Pr. 889)	222
5.22 Setting from the operation panel.....	223
5.22.1 RUN key rotation direction selection (Pr. 40)	223
5.22.2 Operation panel frequency setting/key lock operation selection (Pr. 161)	224
5.22.3 Magnitude of frequency change setting (Pr. 295).....	226
5.23 Parameter clear/ All parameter clear	227
5.24 Initial value change list.....	228
5.25 Check and clear of the faults history	229
6 TROUBLESHOOTING	231
6.1 Reset method of protective function.....	232

6.2	List of fault or alarm indications	233
6.3	Causes and corrective actions.....	234
6.4	Correspondences between digital and actual characters	243
6.5	Check first when you have a trouble.....	244
6.5.1	Motor does not start.....	244
6.5.2	Motor or machine is making abnormal acoustic noise.....	246
6.5.3	Inverter generates abnormal noise	246
6.5.4	Motor generates heat abnormally	246
6.5.5	Motor rotates in the opposite direction.....	247
6.5.6	Speed greatly differs from the setting	247
6.5.7	Acceleration/deceleration is not smooth	247
6.5.8	Speed varies during operation.....	248
6.5.9	Operation mode is not changed properly.....	248
6.5.10	Operation panel display is not operating	249
6.5.11	Motor current is too large.....	249
6.5.12	Speed does not accelerate	250
6.5.13	Unable to write parameter setting.....	250

7 PRECAUTIONS FOR MAINTENANCE AND INSPECTION 251

7.1	Inspection items	252
7.1.1	Daily inspection.....	252
7.1.2	Periodic inspection.....	252
7.1.3	Daily and periodic inspection	253
7.1.4	Display of the life of the inverter parts	254
7.1.5	Checking the inverter and converter modules	254
7.1.6	Cleaning.....	255
7.1.7	Replacement of parts.....	255
7.2	Measurement of main circuit voltages, currents and powers.....	259
7.2.1	Measurement of powers	261
7.2.2	Measurement of voltages and use of PT	261
7.2.3	Measurement of currents.....	262
7.2.4	Use of CT and transducer.....	262
7.2.5	Measurement of inverter input power factor	262
7.2.6	Measurement of converter output voltage (across terminals P/+ and N/-)	262
7.2.7	Insulation resistance test using megger	263
7.2.8	Pressure test.....	263

8 SPECIFICATIONS 265

8.1	Rating	266
------------	---------------------	------------

8.2 Common specifications.....	268
8.3 Outline dimension drawings.....	269
APPENDIX	273
<hr/> <hr/>	
Appendix 1 Main differences with the FR-E500(N) CC-Link model	274
Appendix 2 Specification change	275
Appendix 2-1 SERIAL number check	275
Appendix 2-2 Changed functions	275
Appendix 3 Index.....	276

MEMO

1 OUTLINE

This chapter explains the "OUTLINE" for use of this product. Always read the instructions before using the equipment.

1.1	Product checking and parts identification	2
1.2	Inverter and peripheral devices.....	3
1.3	Removal and reinstallation of the cover.....	5
1.4	Installation of the inverter and enclosure design	8

<Abbreviations>

Inverter	Mitsubishi inverter FR-E700 series CC-Link type
FR-E700-NC.....	Mitsubishi inverter FR-E700 series CC-Link type
Pr.	Parameter number (Number assigned to function)
PU operation	Operation using the operation panel
Mitsubishi standard motor	SF-JR
Mitsubishi constant-torque motor ...	SF-HRCA
Virtual terminal	Input/output device for CC-Link communication. The assigned signal (function) can be selected with input/output terminal function selection parameters (<i>Pr.180 to Pr.184, Pr.190 to Pr.192, Pr.313 to Pr.315</i>).

<Trademarks>

- Company and product names herein are the trademarks and registered trademarks of their respective owners.

<Marks>

 **REMARKS** :Additional helpful contents and relations with other functions are stated

 **NOTE** :Contents requiring caution or cases when set functions are not activated are stated.

 **POINT** :Useful contents and points are stated.

 **Parameters referred to** : Related parameters are stated.

 Specifications differ according to the date assembled. *Refer to page 275* to check the SERIAL number.



1.1 Product checking and parts identification

Unpack the inverter and check the capacity plate on the front cover and the rating plate on the inverter side face to ensure that the product agrees with your order and the inverter is intact.

● **Inverter model**

FR - **E740** - **2.2** KNC

No.	Voltage class
E720	Three-phase 200V class
E740	Three-phase 400V class
E720S	Single-phase 200V class

Represents the inverter capacity [kW]

Operation panel
(Refer to page 80)

Terminating resistor selection switch (SW1)
(Refer to page 50)

CC-Link communication connector (2-port type)
(Refer to page 52)

Front cover
(Refer to page 5)

Cooling fan
(Refer to page 255)

USB connector (mini-B connector)
(Refer to page 220)

LED (operation status indicator)
(Refer to page 75)

Switch for manufacturer setting (SW2)
Do not change the initial setting (OFF).

Standard control circuit terminal block
(Refer to page 20)

Main circuit terminal block
(Refer to page 15)

Combed shaped wiring cover
(Refer to page 7)

Capacity plate *
FR-E720-2.2KNC ← Inverter model
SERIAL: XXXXXX ← Serial number

* Location of the capacity plate and the rating plate differs according to the inverter capacity. Refer to the outline dimension drawing. (Refer to page 269)

Rating plate *

	MITSUBISHI INVERTER
Inverter model	MODEL FR-E720-2.2KNC
Input rating	INPUT : XXXXX
Output rating	OUTPUT : XXXXX
Serial number	SERIAL : _____
	MITSUBISHI ELECTRIC CORPORATION MADE IN JAPAN

PASSED

● **Accessory**

- **P-clip (for M4 screw)**
Use this to ground (earth) the CC-Link dedicated cable. (Refer to page 52)



- **Fan cover fixing screws (M3 × 35mm)**
These screws are necessary for compliance with the EU Directive (Refer to the Instruction Manual (Basic))

Capacity	Quantity
FR-E720-1.5KNC to 3.7KNC, FR-E740-1.5KNC to 3.7KNC, FR-E720S-0.75KNC to 2.2KNC	1
FR-E720-5.5KNC to 15KNC, FR-E740-5.5KNC to 15KNC	2

REMARKS

For how to find the SERIAL number, refer to page 275.

1.2 Inverter and peripheral devices

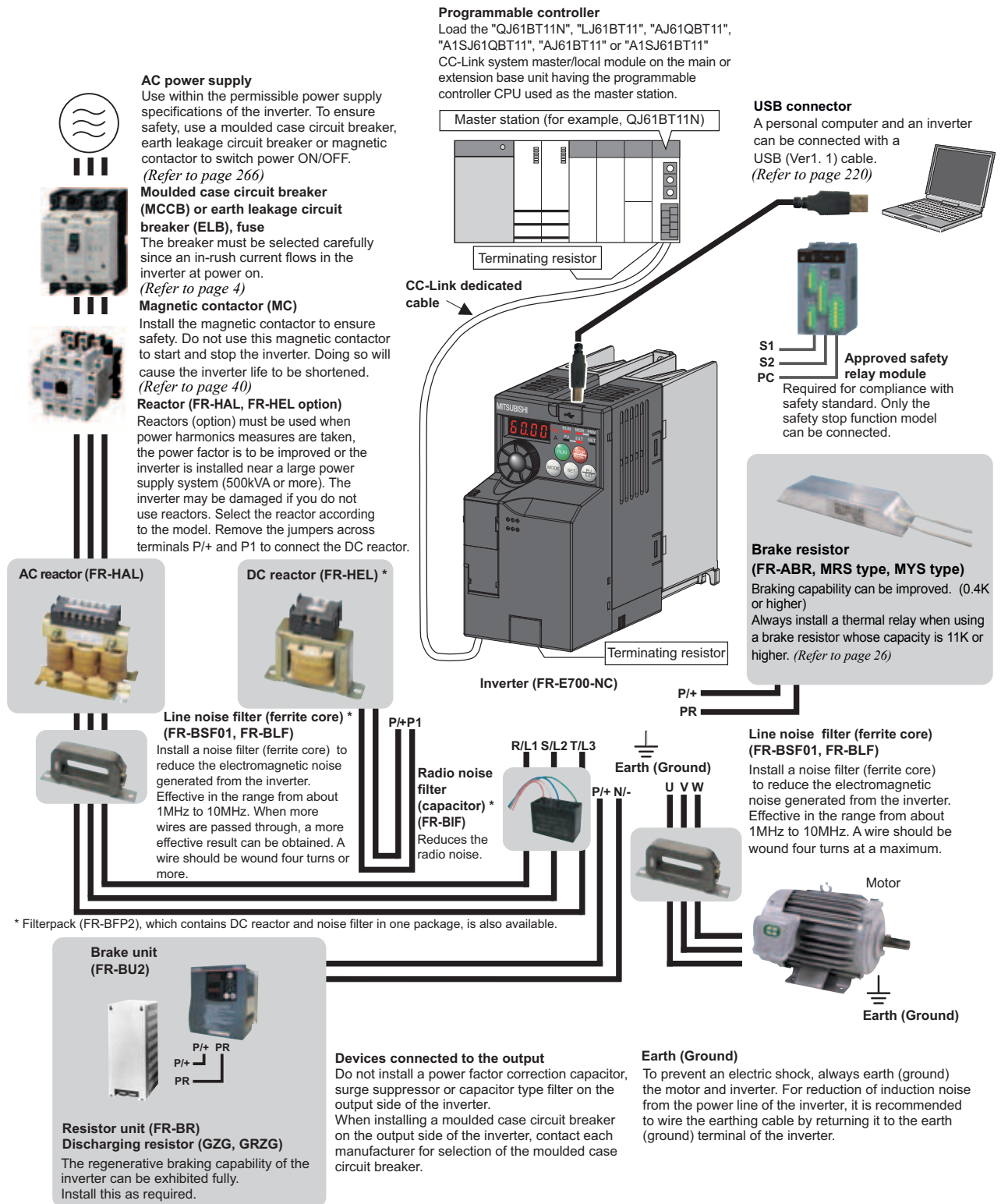

NOTE

- Up to 42 inverters can be connected when using CC-Link communication.
- The life of the inverter is influenced by surrounding air temperature. The surrounding air temperature should be as low as possible within the permissible range. This must be noted especially when the inverter is installed in an enclosure. (Refer to page 8)
- Wrong wiring might lead to damage of the inverter. The control signal lines must be kept fully away from the main circuit to protect them from noise. (Refer to page 14)
- Do not install a power factor correction capacitor, surge suppressor or capacitor type filter on the inverter output side. This will cause the inverter to trip or the capacitor and surge suppressor to be damaged. If any of the above devices are connected, immediately remove them.
- Electromagnetic wave interference
The input/output (main circuit) of the inverter includes high frequency components, which may interfere with the communication devices (such as AM radios) used near the inverter. In this case, install options among the radio noise filter FR-BIF (for use in the input side only), and the line noise filter FR-BSF01/FR-BLF to minimize the interference. (Refer to page 34).
- Refer to the instruction manual of each option and peripheral devices for details of peripheral devices.

1.2.1 Peripheral devices

Check the inverter model of the inverter you purchased. Appropriate peripheral devices must be selected according to the capacity. Refer to the following list and prepare appropriate peripheral devices:

Applicable Inverter Model	Motor Output (kW)	Moulded Case Circuit Breaker (MCCB) *1 or Earth Leakage Circuit Breaker (ELB) *2		Magnetic Contactor (MC) *3		Reactor		
		Reactor connection		Reactor connection		FR-HAL	FR-HEL	
		without	with	without	with			
Three-Phase 200V	FR-E720-0.1KNC	0.1	5A	5A	S-N10	S-N10	0.4K *4	0.4K *4
	FR-E720-0.2KNC	0.2	5A	5A	S-N10	S-N10	0.4K *4	0.4K *4
	FR-E720-0.4KNC	0.4	5A	5A	S-N10	S-N10	0.4K	0.4K
	FR-E720-0.75KNC	0.75	10A	10A	S-N10	S-N10	0.75K	0.75K
	FR-E720-1.5KNC	1.5	15A	15A	S-N10	S-N10	1.5K	1.5K
	FR-E720-2.2KNC	2.2	20A	15A	S-N10	S-N10	2.2K	2.2K
	FR-E720-3.7KNC	3.7	30A	30A	S-N20, S-N21	S-N10	3.7K	3.7K
	FR-E720-5.5KNC	5.5	50A	40A	S-N25	S-N20, S-N21	5.5K	5.5K
	FR-E720-7.5KNC	7.5	60A	50A	S-N25	S-N25	7.5K	7.5K
	FR-E720-11KNC	11	75A	75A	S-N35	S-N35	11K	11K
	FR-E720-15KNC	15	125A	100A	S-N50	S-N50	15K	15K
Three-Phase 400V	FR-E740-0.4KNC	0.4	5A	5A	S-N10	S-N10	H0.4K	H0.4K
	FR-E740-0.75KNC	0.75	5A	5A	S-N10	S-N10	H0.75K	H0.75K
	FR-E740-1.5KNC	1.5	10A	10A	S-N10	S-N10	H1.5K	H1.5K
	FR-E740-2.2KNC	2.2	15A	10A	S-N10	S-N10	H2.2K	H2.2K
	FR-E740-3.7KNC	3.7	20A	15A	S-N10	S-N10	H3.7K	H3.7K
	FR-E740-5.5KNC	5.5	30A	20A	S-N20, S-N21	S-N11, S-N12	H5.5K	H5.5K
	FR-E740-7.5KNC	7.5	30A	30A	S-N20, S-N21	S-N20, S-N21	H7.5K	H7.5K
	FR-E740-11KNC	11	50A	40A	S-N20, S-N21	S-N20, S-N21	H11K	H11K
	FR-E740-15KNC	15	60A	50A	S-N25	S-N20, S-N21	H15K	H15K
Single-Phase 200V	FR-E720S-0.1KNC	0.1	5A	5A	S-N10	S-N10	0.4K *4	0.4K *4
	FR-E720S-0.2KNC	0.2	5A	5A	S-N10	S-N10	0.4K *4	0.4K *4
	FR-E720S-0.4KNC	0.4	10A	10A	S-N10	S-N10	0.75K *4	0.75K *4
	FR-E720S-0.75KNC	0.75	15A	10A	S-N10	S-N10	1.5K *4	1.5K *4
	FR-E720S-1.5KNC	1.5	20A	20A	S-N10	S-N10	2.2K *4	2.2K *4
	FR-E720S-2.2KNC	2.2	40A	30A	S-N20, S-N21	S-N10	3.7K *4	3.7K *4

- *1 •Select an MCCB according to the power supply capacity.
•Install one MCCB per inverter.

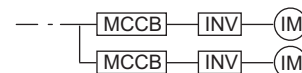

- *2 For the use in the United States or Canada, select a UL and cUL certified fuse with Class T fuse equivalent cut-off speed or faster with the appropriate rating for branch circuit protection. Alternatively, select a UL489 molded case circuit breaker (MCCB).
(Refer to the Instruction Manual (Basic))
- *3 Magnetic contactor is selected based on the AC-1 class. The electrical durability of magnetic contactor is 500,000 times. When the magnetic contactor is used for emergency stop during motor driving, the electrical durability is 25 times.
When using the MC for emergency stop during motor driving or using on the motor side during commercial-power supply operation, select the MC with class AC-3 rated current for the motor rated current.
- *4 The power factor may be slightly lower.



NOTE

- When the inverter capacity is larger than the motor capacity, select an MCCB and a magnetic contactor according to the inverter model and cable and reactor according to the motor output.
- When the breaker on the inverter input side trips, check for a wiring fault (short circuit), damage to internal parts of the inverter, etc. Identify the cause of the trip, then remove the cause and power on the breaker.

1.3 Removal and reinstallation of the cover

1.3.1 Front cover

FR-E720-3.7KNC or lower, FR-E740-7.5KNC or lower, FR-E720S-0.1KNC to 2.2KNC

●Removal (Example of FR-E720-0.75KNC)

Remove the front cover by pulling it toward you in the direction of arrow.

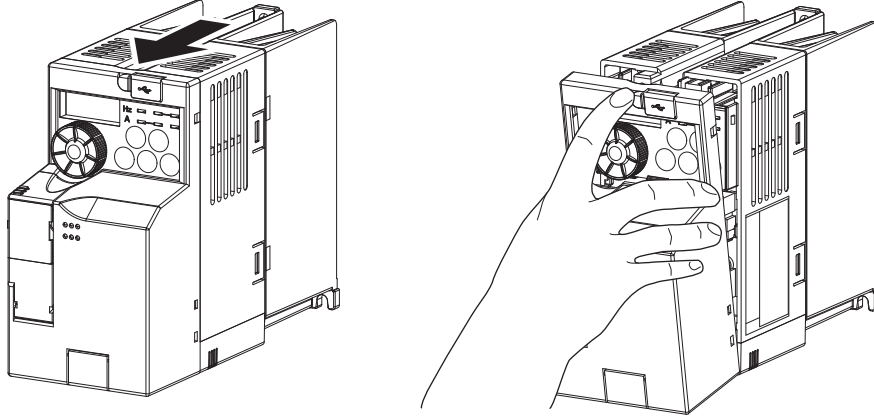

●Reinstallation (Example of FR-E720-0.75KNC)

To reinstall, match the cover to the inverter front and install it straight.

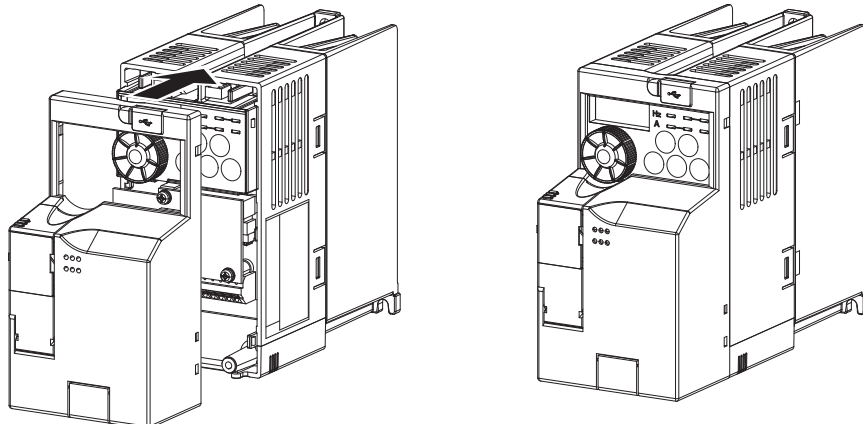

7 Removal and reinstallation of the cover

FR-E720-5.5KNC or higher, FR-E740-11KNC or higher

●Removal (Example of FR-E720-5.5KNC)

- 1) Loosen the installation screws of the front cover 1.
- 2) Remove the front cover 1 by pulling it toward you in the direction of arrow.
- 3) Remove the front cover 2 by pulling it toward you in the direction of arrow.

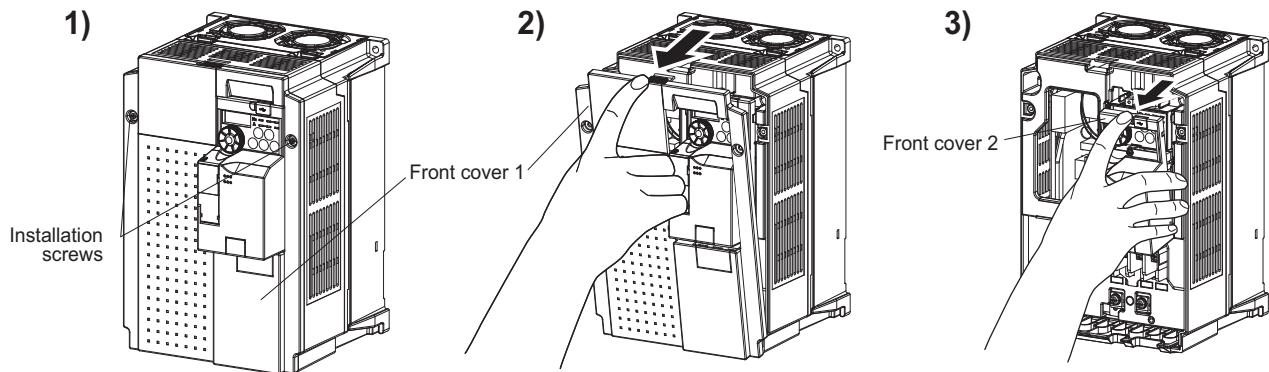

●Reinstallation (Example of FR-E720-5.5KNC)

- 1) Match the front cover 2 to the inverter front and install it straight.
- 2) Insert the two fixed hooks on the lower side of the front cover 1 into the sockets of the inverter.
- 3) Tighten the screw of the front cover 1.

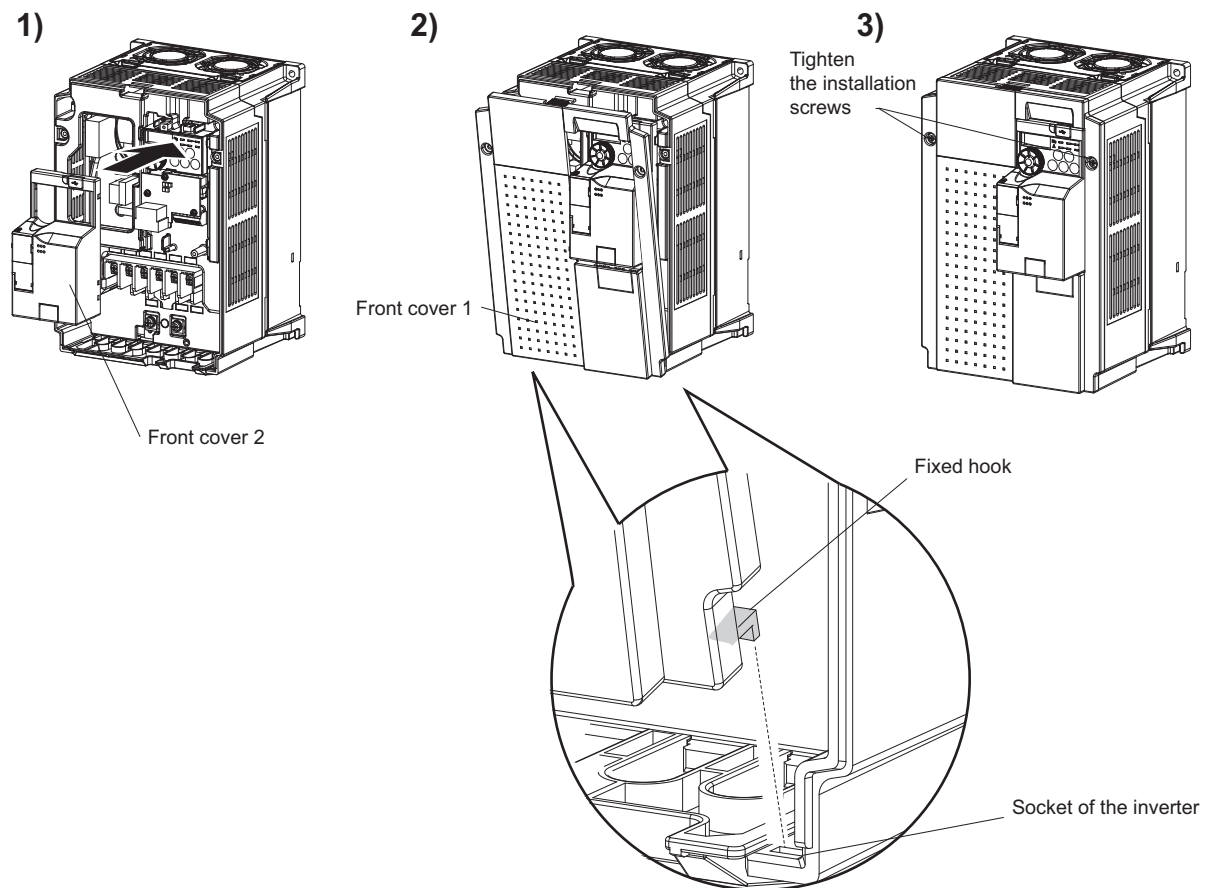

NOTE

- Fully make sure that the front cover has been reinstalled securely.
- The same serial number is printed on the capacity plate of the front cover and the rating plate of the inverter. Since these plates have the same serial numbers, always reinstall the removed cover onto the original inverter.

1.3.2 Wiring cover

●Removal and reinstallation

The cover can be removed easily by pulling it toward you. To reinstall, fit the cover to the inverter along the guides.

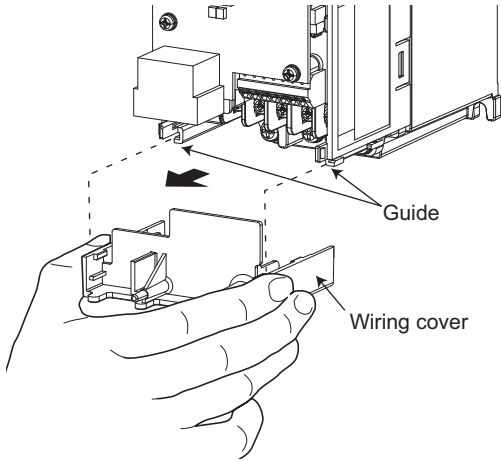
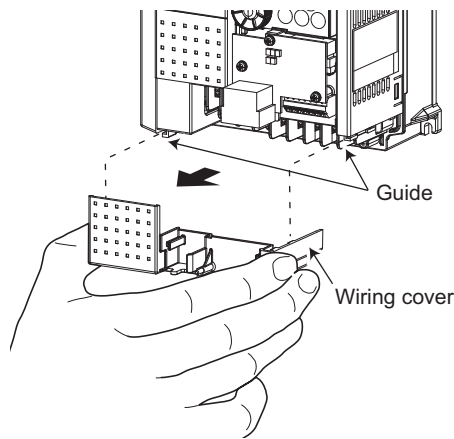
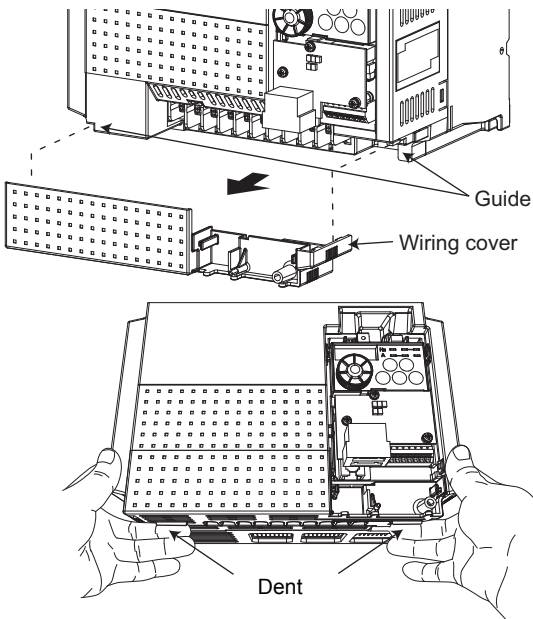
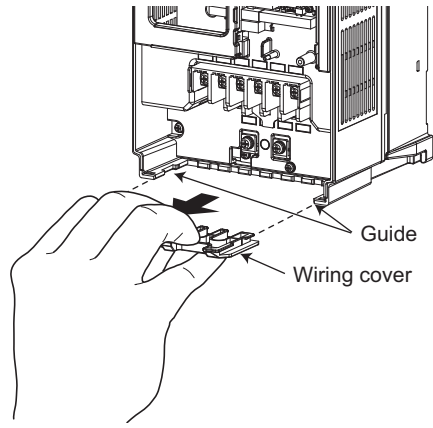
<p>FR-E720-0.1KNC to 0.75KNC FR-E720S-0.1KNC to 0.4KNC</p>	<p>FR-E720-1.5KNC to 3.7KNC FR-E740-0.4KNC to 3.7KNC FR-E720S-0.75KNC to 2.2KNC</p>
 <p>Example of FR-E720-0.75KNC</p>	 <p>Example of FR-E740-3.7KNC</p>
<p>FR-E740-5.5KNC, 7.5KNC</p>	<p>FR-E720-5.5KNC to 15KNC FR-E740-11KNC, 15KNC</p>
 <p>For removal, push the dent on the wiring cover with your finger and pull toward you.</p> <p>Example of FR-E740-5.5KNC</p>	 <p>Example of FR-E720-5.5KNC</p>

1.4 Installation of the inverter and enclosure design

When an inverter enclosure is to be designed and manufactured, heat generated by contained equipment, etc., the environment of an operating place, and others must be fully considered to determine the enclosure structure, size and equipment layout. The inverter unit uses many semiconductor devices. To ensure higher reliability and long period of operation, operate the inverter in the ambient environment that completely satisfies the equipment specifications.

1.4.1 Inverter installation environment

As the inverter installation environment should satisfy the standard specifications indicated in the following table, operation in any place that does not meet these conditions not only deteriorates the performance and life of the inverter, but also causes a failure. Refer to the following points and take adequate measures.

Environmental standard specifications of inverter

Item	Description
Surrounding air temperature	-10 to +50°C (non-freezing)
Ambient humidity	90%RH or less (non-condensing)
Atmosphere	Indoors (free from corrosive gas, flammable gas, oil mist, dust and dirt)
Maximum altitude	1,000m or less
Vibration	5.9m/s ² or less at 10 to 55Hz (directions of X, Y, Z axes)

(1) Temperature

The permissible surrounding air temperature of the inverter is between -10 and +50°C. Always operate the inverter within this temperature range. Operation outside this range will considerably shorten the service lives of the semiconductors, parts, capacitors and others. Take the following measures so that the surrounding air temperature of the inverter falls within the specified range.

- 1) Measures against high temperature
 - Use a forced ventilation system or similar cooling system. (*Refer to page 10*)
 - Install the panel in an air-conditioned electrical chamber.
 - Block direct sunlight.
 - Provide a shield or similar plate to avoid direct exposure to the radiated heat and wind of a heat source.
 - Ventilate the area around the panel well.
- 2) Measures against low temperature
 - Provide a space heater in the enclosure.
 - Do not power off the inverter. (Keep the start signal of the inverter off.)
- 3) Sudden temperature changes
 - Select an installation place where temperature does not change suddenly.
 - Avoid installing the inverter near the air outlet of an air conditioner.
 - If temperature changes are caused by opening/closing of a door, install the inverter away from the door.

(2) Humidity

Normally operate the inverter within the 45 to 90% range of the ambient humidity. Too high humidity will pose problems of reduced insulation and metal corrosion. On the other hand, too low humidity may produce a spatial electrical breakdown. The insulation distance specified in JEM1103 "Control Equipment Insulator" is defined as humidity 45 to 85%.

- 1) Measures against high humidity
 - Make the panel enclosed, and provide it with a hygroscopic agent.
 - Take dry air into the enclosure from outside.
 - Provide a space heater in the enclosure.
- 2) Measures against low humidity

What is important in fitting or inspection of the unit in this status is to discharge your body (static electricity) beforehand and keep your body from contact with the parts and patterns, besides blowing air of proper humidity into the panel from outside.
- 3) Measures against condensation

Condensation may occur if frequent operation stops change the in-panel temperature suddenly or if the outside-air temperature changes suddenly.

Condensation causes such faults as reduced insulation and corrosion.

 - Take the measures against high humidity in 1).
 - Do not power OFF the inverter. (Keep the start signal of the inverter OFF.)

(3) Dust, dirt, oil mist

Dust and dirt will cause such faults as poor contact of contact points, reduced insulation or reduced cooling effect due to moisture absorption of accumulated dust and dirt, and in-panel temperature rise due to clogged filter. In the atmosphere where conductive powder floats, dust and dirt will cause such faults as malfunction, deteriorated insulation and short circuit in a short time.

Since oil mist will cause similar conditions, it is necessary to take adequate measures.

Countermeasures

- Place in a totally enclosed enclosure.
Take measures if the in-enclosure temperature rises. (*Refer to page 10*)
- Purge air.
Pump clean air from outside to make the in-panel pressure higher than the outside-air pressure.

(4) Corrosive gas, salt damage

If the inverter is exposed to corrosive gas or to salt near a beach, the printed board patterns and parts will corrode or the relays and switches will result in poor contact.

In such places, take the measures given in Section 3.

(5) Explosive, flammable gases

As the inverter is non-explosion proof, it must be contained in an explosion proof enclosure. In places where explosion may be caused by explosive gas, dust or dirt, an enclosure cannot be used unless it structurally complies with the guidelines and has passed the specified tests. This makes the enclosure itself expensive (including the test charges). The best way is to avoid installation in such places and install the inverter in a non-hazardous place.

(6) Highland

Use the inverter at the altitude of within 1000m. If it is used at a higher place, it is likely that thin air will reduce the cooling effect and low air pressure will deteriorate dielectric strength.

(7) Vibration, impact

The vibration resistance of the inverter is up to 5.9m/s^2 at 10 to 55Hz frequency and 1mm amplitude for the directions of X, Y, Z axes. Vibration or impact, if less than the specified value, applied for a long time may make the mechanism loose or cause poor contact to the connectors.

Especially when impact is imposed repeatedly, caution must be taken as the part pins are likely to break.

Countermeasures

- Provide the panel with rubber vibration isolators.
- Strengthen the structure to prevent the panel from resonance.
- Install the panel away from sources of vibration.

1.4.2 Cooling system types for inverter enclosure

From the enclosure that contains the inverter, the heat of the inverter and other equipment (transformers, lamps, resistors, etc.) and the incoming heat such as direct sunlight must be dissipated to keep the in-panel temperature lower than the permissible temperatures of the in-panel equipment including the inverter.

The cooling systems are classified as follows in terms of the cooling calculation method.

- 1) Cooling by natural heat dissipation from the enclosure surface (totally enclosed type)
- 2) Cooling by heatsink (aluminum fin, etc.)
- 3) Cooling by ventilation (forced ventilation type, pipe ventilation type)
- 4) Cooling by heat exchanger or cooler (heat pipe, cooler, etc.)

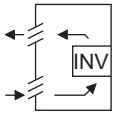
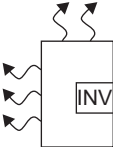
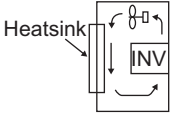
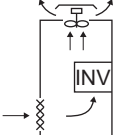
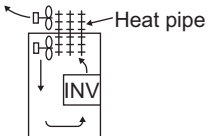
Cooling System	Enclosure Structure	Comment
Natural cooling	Natural ventilation (enclosed, open type) 	Low in cost and generally used, but the enclosure size increases as the inverter capacity increases. For relatively small capacities.
	Natural ventilation (totally enclosed type) 	Being a totally enclosed type, the most appropriate for hostile environment having dust, dirt, oil mist, etc. The enclosure size increases depending on the inverter capacity.
Forced cooling	Fin cooling 	Having restrictions on the heatsink mounting position and area, and designed for relative small capacities.
	Forced ventilation 	For general indoor installation. Appropriate for enclosure downsizing and cost reduction, and often used.
	Heat pipe 	Totally enclosed type for enclosure downsizing.

1.4.3 Inverter placement

(1) Installation of the inverter

Enclosure surface mounting

Remove the front cover and wiring cover to fix the inverter to the surface. (Remove the covers in the directions of the arrows.)

- FR-E720-0.1KNC to 0.75KNC
- FR-E720S-0.1KNC to 0.4KNC

- FR-E720-1.5KNC or higher
- FR-E740-0.4KNC or higher
- FR-E720S-0.75KNC or higher

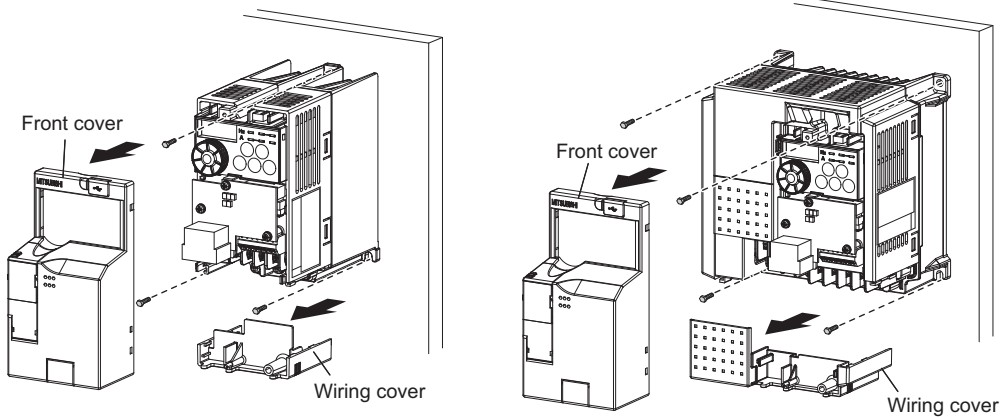

Note

- When encasing multiple inverters, install them in parallel as a cooling measure.
- Install the inverter vertically.
- For heat dissipation and maintenance, take at least the clearances shown in the table below from the inverter to the other devices and to the enclosure surface.

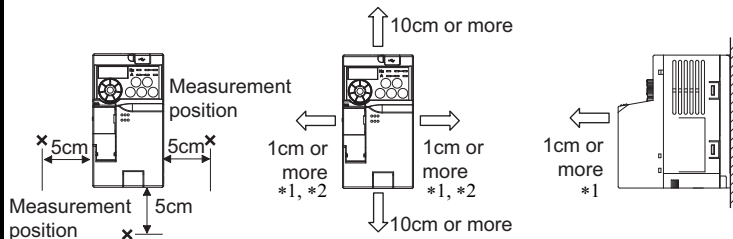

-10 °C to +50 °C (non-freezing)

*1 Take 5cm or more clearances for 5.5K or higher.

*2 When using the inverters at the surrounding air temperature of 40°C or less, the inverters can be installed without any clearance between them (0cm clearance).

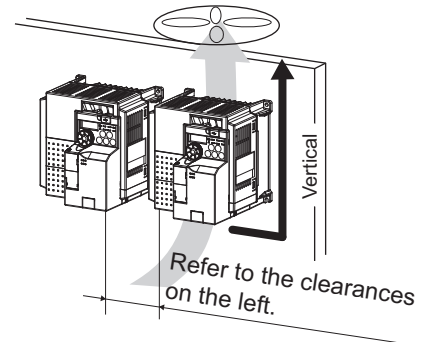

(2) Above inverter

Heat is blown up from inside the inverter by the small fan built in the unit. Any equipment placed above the inverter should be heat resistant.

(3) Arrangement of multiple inverters

When multiple inverters are placed in the same enclosure, generally arrange them horizontally as shown in the right figure (a). When it is inevitable to arrange them vertically to minimize space, take such measures as to provide guides since heat from the bottom inverters can increase the temperatures in the top inverters, causing inverter failures.

When mounting multiple inverters, fully take caution not to make the surrounding air temperature of the inverter higher than the permissible value by providing ventilation and increasing the enclosure size.

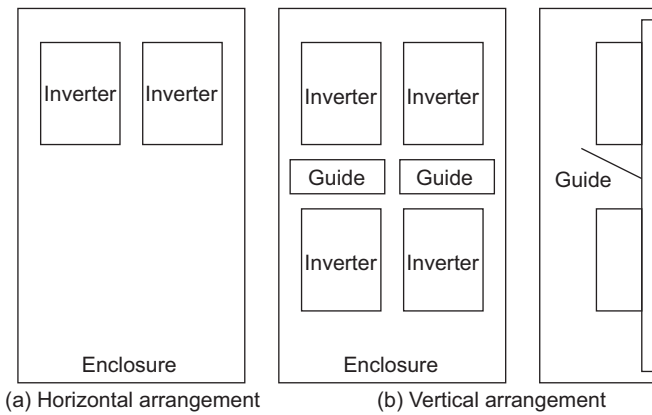

(a) Horizontal arrangement (b) Vertical arrangement
Arrangement of multiple inverters

(4) Arrangement of ventilation fan and inverter

Heat generated in the inverter is blown up from the bottom of the unit as warm air by the cooling fan. When installing a ventilation fan for that heat, determine the place of ventilation fan installation after fully considering the air flow. (Air passes through areas of low resistance. Make an airway and airflow plates to expose the inverter to cool air.)

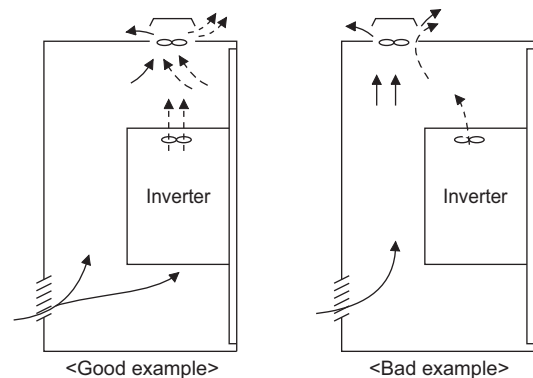

<Good example> <Bad example>
Placement of ventilation fan and inverter

2 WIRING

This chapter describes the basic "WIRING" for use of this product.
Always read the instructions before using the equipment.

2.1	Wiring.....	14
2.2	Main circuit terminal specifications	15
2.3	Control circuit specifications	20
2.4	Connection of stand-alone option unit	26

1

2

3

4

5

6

7

8

2.1 Wiring

2.1.1 Terminal connection diagram

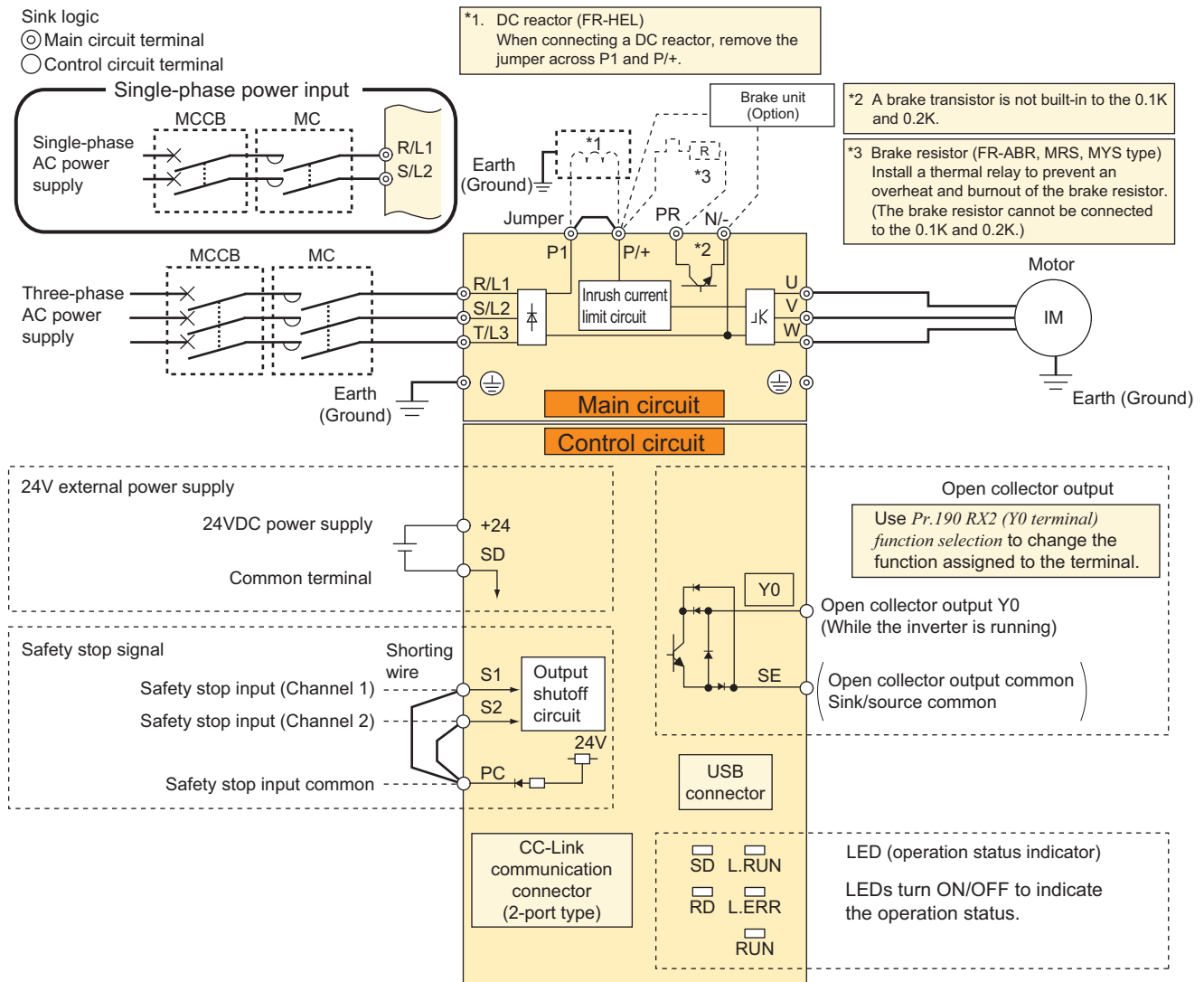

NOTE

- To prevent a malfunction caused by noise, separate the signal cables more than 10cm from the power cables. Also, separate the main circuit cables of the input side from the main circuit cables of the output side.
- After wiring, cables offcuts must not be left in the inverter.
Wire offcuts can cause an alarm, failure or malfunction. Always keep the inverter clean. When drilling mounting holes in an enclosure etc., take caution not to allow chips and other foreign matter to enter the inverter.
- The output of the single-phase power input model is three-phase 200V.

2.2 Main circuit terminal specifications

2.2.1 Specification of main circuit terminal

Terminal Symbol	Terminal Name	Description
R/L1, S/L2, T/L3 *1	AC power input	Connect to the commercial power supply.
U, V, W	Inverter output	Connect a three-phase squirrel-cage motor.
P/+, PR	Brake resistor connection	Connect a brake resistor (FR-ABR, MRS type, MYS type) across terminals P/+ and PR. (The brake resistor cannot be connected to the 0.1K or 0.2K.)
P/+, N/-	Brake unit connection	Connect a brake unit (FR-BU2).
P/+, P1	DC reactor connection	Remove the jumper across terminals P/+ and P1 and connect a DC reactor.
	Earth (Ground)	For earthing (grounding) the inverter chassis. Must be earthed (grounded).

*1 When using a single-phase power input model, terminals are R/L1 and S/L2.

2.2.2 Terminal arrangement of the main circuit terminal, power supply and the motor wiring

Three-phase 200V class

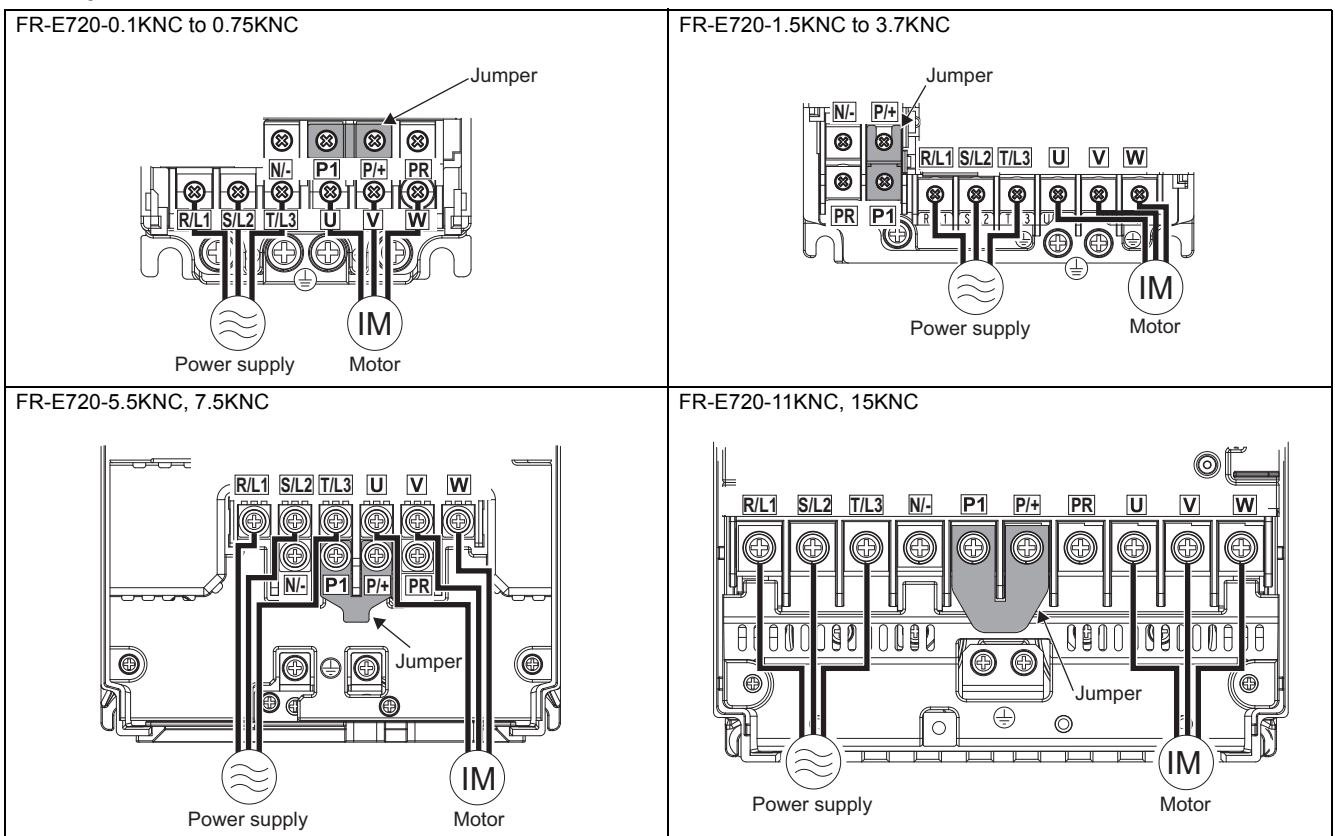

7 Main circuit terminal specifications

Three-phase 400V class

FR-E740-0.4KNC to 3.7KNC

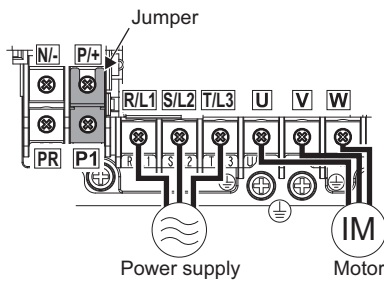

FR-E740-5.5KNC, 7.5KNC

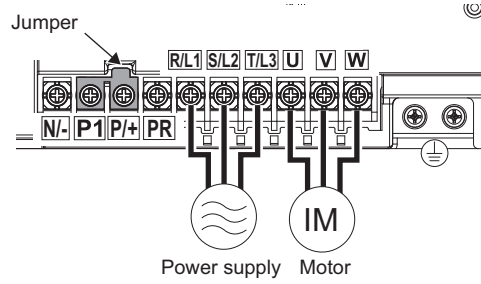

FR-E740-11KNC, 15KNC

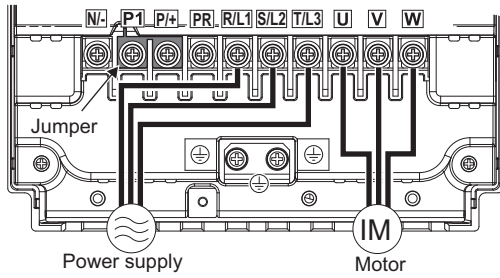

Single-phase 200V class

FR-E720S-0.1KNC to 0.4KNC

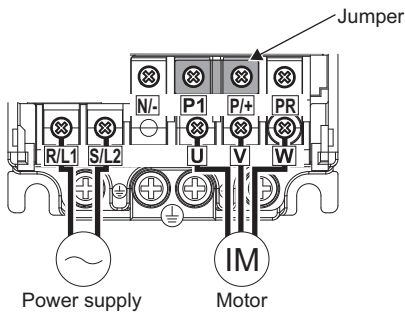

FR-E720S-0.75KNC to 2.2KNC

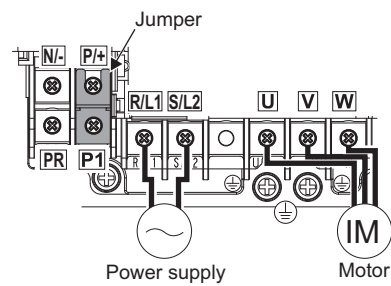

NOTE

- Make sure the power cables are connected to the R/L1, S/L2, T/L3. (Phase need not be matched.) Never connect the power cable to the U, V, W of the inverter. Doing so will damage the inverter.
- Connect the motor to U, V, W. Turning ON the forward rotation switch (signal) at this time rotates the motor counterclockwise when viewed from the load shaft.

2.2.3 Cables and wiring length

(1) Applicable cable size

Select the recommended cable size to ensure that a voltage drop will be 2% or less.

If the wiring distance is long between the inverter and motor, a main circuit cable voltage drop will cause the motor torque to decrease especially at the output of a low frequency.

The following table indicates a selection example for the wiring length of 20m.

Three-phase 200V class (when input power supply is 220V)

Applicable Inverter Model	Terminal Screw Size *4	Tightening Torque N·m	Crimping Terminal		Cable Size							
					HIV Cables, etc. (mm ²) *1			AWG *2		PVC Cables, etc. (mm ²) *3		
					R/L1 S/L2 T/L3	U, V, W	R/L1 S/L2 T/L3	U, V, W	Earthing (grounding) cable	R/L1 S/L2 T/L3	U, V, W	R/L1 S/L2 T/L3
FR-E720-0.1KNC to 0.75KNC	M3.5	1.2	2-3.5	2-3.5	2	2	2	14	14	2.5	2.5	2.5
FR-E720-1.5KNC, 2.2KNC	M4	1.5	2-4	2-4	2	2	2	14	14	2.5	2.5	2.5
FR-E720-3.7KNC	M4	1.5	5.5-4	5.5-4	3.5	3.5	3.5	12	12	4	4	4
FR-E720-5.5KNC	M5	2.5	5.5-5	5.5-5	5.5	5.5	5.5	10	10	6	6	6
FR-E720-7.5KNC	M5	2.5	14-5	8-5	14	8	5.5	6	8	16	10	6
FR-E720-11KNC	M5	2.5	14-5	14-5	14	14	14	6	6	16	16	16
FR-E720-15KNC	M6(M5)	4.4	22-6	22-6	22	22	14	4	4	25	25	16

Three-phase 400V class (when input power supply is 440V)

Applicable Inverter Model	Terminal Screw Size *4	Tightening Torque N·m	Crimping Terminal		Cable Size							
					HIV Cables, etc. (mm ²) *1			AWG *2		PVC Cables, etc. (mm ²) *3		
					R/L1 S/L2 T/L3	U, V, W	R/L1 S/L2 T/L3	U, V, W	Earthing (grounding) cable	R/L1 S/L2 T/L3	U, V, W	R/L1 S/L2 T/L3
FR-E740-0.4KNC to 3.7KNC	M4	1.5	2-4	2-4	2	2	2	14	14	2.5	2.5	2.5
FR-E740-5.5KNC	M4	1.5	5.5-4	2-4	3.5	2	3.5	12	14	4	2.5	4
FR-E740-7.5KNC	M4	1.5	5.5-4	5.5-4	3.5	3.5	3.5	12	12	4	4	4
FR-E740-11KNC	M4	1.5	5.5-4	5.5-4	5.5	5.5	8	10	10	6	6	10
FR-E740-15KNC	M5	2.5	8-5	8-5	8	8	8	8	8	10	10	10

Single-phase 200V class (when input power supply is 220V)

Applicable Inverter Model	Terminal Screw Size *4	Tightening Torque N·m	Crimping Terminal		Cable Size							
					HIV Cables, etc. (mm ²) *1			AWG *2		PVC Cables, etc. (mm ²) *3		
					R/L1 S/L2	U, V, W	R/L1 S/L2	U, V, W	Earthing (grounding) cable	R/L1 S/L2	U, V, W	R/L1 S/L2
FR-E720S-0.1KNC to 0.4KNC	M3.5	1.2	2-3.5	2-3.5	2	2	2	14	14	2.5	2.5	2.5
FR-E720S-0.75KNC	M4	1.5	2-4	2-4	2	2	2	14	14	2.5	2.5	2.5
FR-E720S-1.5KNC	M4	1.5	2-4	2-4	2	2	2	14	14	2.5	2.5	2.5
FR-E720S-2.2KNC	M4	1.5	5.5-4	2-4	3.5	2	2	12	14	4	2.5	2.5

*1 The cable size is that of the cable (HIV cable (600V class 2 vinyl-insulated cable) etc.) with continuous maximum permissible temperature of 75°C. Assumes that the surrounding air temperature is 50°C or less and the wiring distance is 20m or less.

*2 The recommended cable size is that of the cable (THHW cable) with continuous maximum permissible temperature of 75°C. Assumes that the surrounding air temperature is 40°C or less and the wiring distance is 20m or less. (Selection example for use mainly in the United States.)

*3 The recommended cable size is that of the cable (PVC cable) with continuous maximum permissible temperature of 70°C. Assumes that the surrounding air temperature is 40°C or less and the wiring distance is 20m or less. (Selection example for use mainly in Europe.)

*4 The terminal screw size indicates the terminal size for R/L1, S/L2, T/L3, U, V, W, and a screw for earthing (grounding).

A screw for earthing (grounding) of the FR-E720-15KNC is indicated in ().

(For single-phase power input, the terminal screw size indicates the size of terminal screw for R/L1, S/L2, U, V, W, PR, P+, N/-, P1 and a screw for earthing (grounding).)



NOTE

- Tighten the terminal screw to the specified torque. A screw that has been tightened too loosely can cause a short circuit or malfunction. A screw that has been tightened too tightly can cause a short circuit or malfunction due to the unit breakage.
- Use crimping terminals with insulation sleeve to wire the power supply and motor.

The line voltage drop can be calculated by the following formula:

$$\text{Line voltage drop [V]} = \frac{\sqrt{3} \times \text{wire resistance [m}\Omega/\text{m}] \times \text{wiring distance [m]} \times \text{current [A]}}{1000}$$

Use a larger diameter cable when the wiring distance is long or when it is desired to decrease the voltage drop (torque reduction) in the low speed range.

(2) Earthing (Grounding) precautions

- Always earth (ground) the motor and inverter.

1) Purpose of earthing (grounding)

Generally, an electrical apparatus has an earth (ground) terminal, which must be connected to the ground before use. An electrical circuit is usually insulated by an insulating material and encased. However, it is impossible to manufacture an insulating material that can shut off a leakage current completely, and actually, a slight current flow into the case. The purpose of earthing (grounding) the case of an electrical apparatus is to prevent operator from getting an electric shock from this leakage current when touching it.

To avoid the influence of external noises, this earthing (grounding) is important to audio equipment, sensors, computers and other apparatuses that handle low-level signals or operate very fast.

2) Earthing (grounding) methods and earthing (grounding) work

As described previously, earthing (grounding) is roughly classified into an electrical shock prevention type and a noise-affected malfunction prevention type. Therefore, these two types should be discriminated clearly, and the following work must be done to prevent the leakage current having the inverter's high frequency components from entering the malfunction prevention type earthing (grounding):

(a) If possible, use (I) independent earthing (grounding) in figure below for the inverter. If independent earthing (grounding) is not available, use (II) joint earthing (grounding) in the figure below which the inverter is connected with the other equipment at an earthing (grounding) point. The (III) common earthing (grounding) as in the figure below, which inverter shares a common earthing (grounding) cable with the other equipment, must be avoided.

A leakage current including many high frequency components flows in the earthing cables of the inverter and inverter-driven motor. Therefore, use the independent earthing (grounding) and separate the earthing (grounding) cable of the inverter from equipment sensitive to EMI.

In a high building, it may be effective to use the EMI prevention type earthing (grounding) connecting to an iron structure frame, and electric shock prevention type earthing (grounding) with the independent earthing (grounding) together.

(b) This inverter must be earthed (grounded). Earthing (Grounding) must conform to the requirements of national and local safety regulations and electrical codes. (NEC section 250, IEC 536 class 1 and other applicable standards).

Use a neutral-point earthed (grounded) power supply for 400V class inverter in compliance with EN standard.

(c) Use the thickest possible earthing (grounding) cable. The earthing (grounding) cable size should be no less than the size indicated in the table on the *page 17*.

(d) The grounding point should be as close as possible to the inverter, and the ground wire length should be as short as possible.

(e) Run the earthing (grounding) cable as far away as possible from the I/O wiring of equipment sensitive to noises and run them in parallel in the minimum distance.

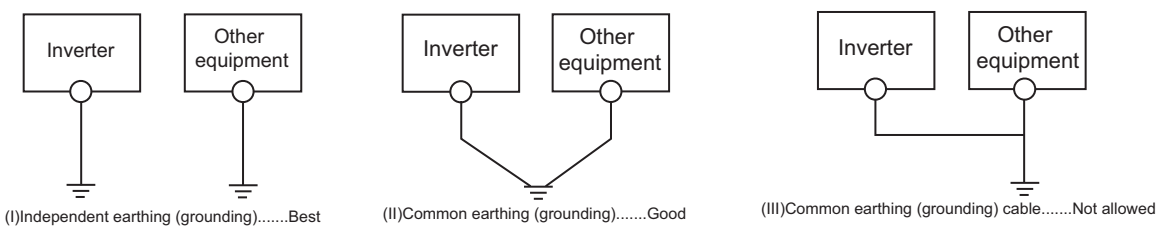

POINT

To be compliant with the EU Directive (Low Voltage Directive),  refer to the Instruction Manual (Basic).

(3) Total wiring length

The overall wiring length for connection of a single motor or multiple motors should be within the value in the table below.

Pr. 72 PWM frequency selection Setting (carrier frequency)		0.1K	0.2K	0.4K	0.75K	1.5K	2.2K	3.7K or higher
1 (1kHz) or less	200V class	200m	200m	300m	500m	500m	500m	500m
	400V class	-	-	200m	200m	300m	500m	500m
2 to15 (2kHz to 14.5kHz)	200V class	30m	100m	200m	300m	500m	500m	500m
	400V class	-	-	30m	100m	200m	300m	500m

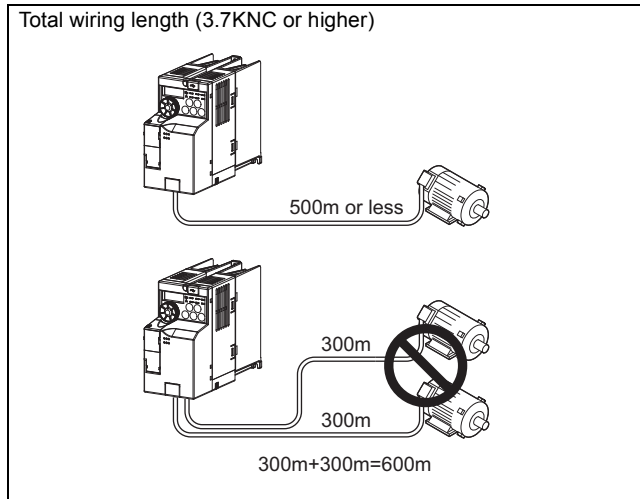

When driving a 400V class motor by the inverter, surge voltages attributable to the wiring constants may occur at the motor terminals, deteriorating the insulation of the motor. (Refer to page 124)



NOTE

- Especially for long-distance wiring, the inverter may be affected by a charging current caused by the stray capacitances of the wiring, leading to a malfunction of the overcurrent protective function, fast response current limit function, or stall prevention function or a malfunction or fault of the equipment connected on the inverter output side. If malfunction of fast-response current limit function occurs, disable this function. If malfunction of stall prevention function occurs, increase the stall level. (Refer to page 120 for Pr. 22 Stall prevention operation level and Pr. 156 Stall prevention operation selection)
- Refer to page 192 for details of Pr. 72 PWM frequency selection.
- When using the automatic restart after instantaneous power failure function with wiring length exceeding 100m, select without frequency search (Pr. 162 = "1 (initial value), 11"). (Refer to page 180)

2.3 Control circuit specifications

2.3.1 Control circuit terminal

□ indicates that terminal functions can be selected using *Pr.190 RX2 (terminal Y0) function selection*. (Refer to page 167).

(1) Input signal

Type	Terminal Symbol	Terminal Name	Description	Rated Specifications	Refer to Page
24V external power supply	+24	24V external power supply	Even when the main circuit power supply is OFF, CC-Link communication continues with the input from the 24V external power supply.	Input voltage 23.5 to 26.5VDC Input current 0.7A or less	23
	SD	24V external power supply common terminal	Common terminal for the terminal +24	—	—
Safety stop function	S1	Safety stop input (Channel 1)	Terminal S1/S2 are safety stop signals for use with in conjunction with an approved external safety unit. Both terminal S1/S2 must be used in dual channel form. Inverter output is shutoff depending on shorting/opening between S1 and PC, S2 and PC. In the initial status, terminal S1 and S2 are shorted with terminal PC by shorting wire. Remove the shorting wire and connect the safety relay module when using the safety stop function.	Input resistance 4.7kΩ Voltage when contacts are open 21 to 26VDC When contacts are short-circuited 4 to 6mADC	24
	S2	Safety stop input (Channel 2)			
	PC	Safety stop input terminal common	Common terminal for safety stop input terminals S1 and S2.	—	—

(2) Output signal

Type	Terminal Symbol	Terminal Name	Description	Rated Specifications	Refer to Page
Open collector	Y0	Open collector output Y0 (Inverter running)	Switched low when the inverter output frequency is equal to or higher than the starting frequency (initial value 0.5Hz). Switched high during stop or DC injection brake operation. (Low indicates that the open collector output transistor is ON (conducts). High indicates that the transistor is OFF (does not conduct).) Use <i>Pr. 190 RX2 (terminal Y0) function selection</i> to change the function assigned to the terminal.	Permissible load 24VDC (maximum 27VDC) 0.1A (a voltage drop is 3.4V maximum when the signal is ON)	24, 167
	SE	Open collector output common	Common terminal of terminal Y0.	—	—

(3) Communication

CC-Link communication can be performed with the CC-Link communication connector.

Type	Connector Name	Pin Arrangement	Pin Number	Signal Name	Communication Connector Plug	Refer to Page					
CC-Link	CONA		CONA	1	DA	One-touch connector for CC-Link communication	52				
				2	DB						
	CONB		CONB	3	DG						
	4			NC							
				5	SLD						
		<table border="1"> <thead> <tr> <th>Model Name</th> <th>Manufacturer</th> </tr> </thead> <tbody> <tr> <td>A6CON-L5P</td> <td>Mitsubishi Electric Corporation</td> </tr> <tr> <td>35505-6000-B0M GF</td> <td>Sumitomo 3M Limited</td> </tr> </tbody> </table>		Model Name	Manufacturer	A6CON-L5P	Mitsubishi Electric Corporation	35505-6000-B0M GF	Sumitomo 3M Limited		
Model Name	Manufacturer										
A6CON-L5P	Mitsubishi Electric Corporation										
35505-6000-B0M GF	Sumitomo 3M Limited										

Type	Terminal Symbol	Terminal Name	Description	Refer to Page
USB	—	USB connector	The FR Configurator can be operated by connecting the inverter to the personal computer through USB. <ul style="list-style-type: none"> • Interface: conforms to USB1.1 • Transmission speed: 12Mbps • Connector: USB mini B connector (receptacle mini B type) 	220

2.3.2 Wiring of control circuit

(1) Control circuit terminal model

Recommend wire size:
0.3mm² to 0.75mm²

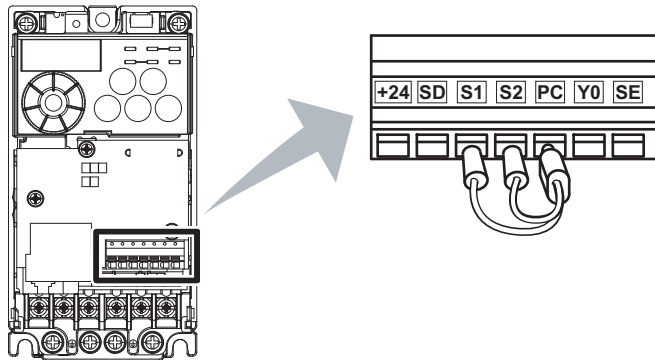

(2) Wiring method

● Wiring

Use a blade terminal and a wire with a sheath stripped off for the control circuit wiring. For a single wire, strip off the sheath of the wire and apply directly. Insert the blade terminal or the single wire into a socket of the terminal.

- Strip off the sheath about the size below. If the length of the sheath peeled is too long, a short circuit may occur among neighboring wires. If the length is too short, wires might come off. Wire the stripped wire after twisting it to prevent it from becoming loose. In addition, do not solder it.



- Crimp the blade terminal. Insert wires to a blade terminal, and check that the wires come out for about 0 to 0.5 mm from a sleeve. Check the condition of the blade terminal after crimping. Do not use a blade terminal of which the crimping is inappropriate, or the face is damaged.

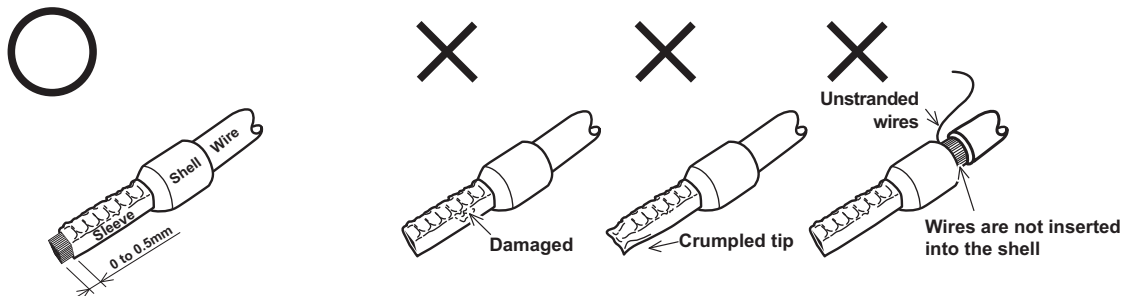

Blade terminals available on the market (as of January 2010)

●Phoenix Contact Co.,Ltd.

Wire Size (mm ²)	Blade Terminal Model			Blade terminal crimping tool
	with insulation sleeve	without insulation sleeve	for UL wire*	
0.3	AI 0,5-10WH	—	—	CRIMPFOX 6
0.5	AI 0,5-10WH	—	AI 0,5-10WH-GB	
0.75	AI 0,75-10GY	A 0,75-10	AI 0,75-10GY-GB	
1	AI 1-10RD	A1-10	AI 1-10RD/1000GB	
1.25, 1.5	AI 1,5-10BK	A1,5-10	—	
0.75 (for two wires)	AI-TWIN 2 x 0,75-10GY	—	—	

* A blade terminal with an insulation sleeve compatible with MTW wire which has a thick wire insulation

●NICHIFU Co.,Ltd.

Wire Size (mm ²)	Blade terminal product number	Insulation product number	Blade terminal crimping tool
0.3 to 0.75	BT 0.75-11	VC 0.75	NH 67

3) Insert the wire into a socket.

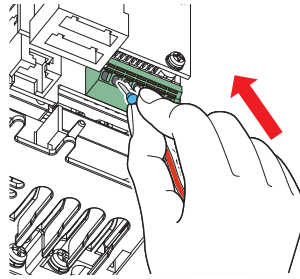

When using a single wire or stranded wire without a blade terminal, push an open/close button all the way down with a flathead screwdriver, and insert the wire.

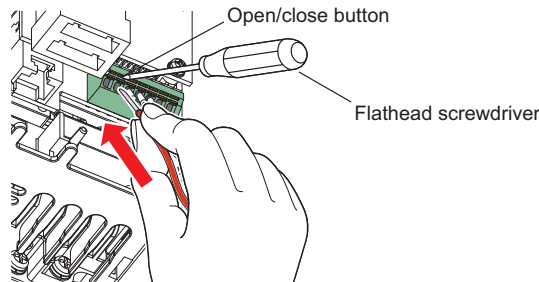

NOTE

- When using a stranded wire without a blade terminal, twist enough to avoid short circuit with a nearby terminals or wires.
- Place the flathead screwdriver vertical to the open/close button. In case the blade tip slips, it may cause to damage of inverter or injury.

● Wire removal

Pull the wire with pushing the open/close button all the way down firmly with a flathead screwdriver.

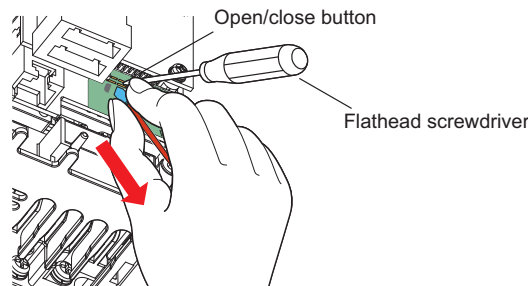

NOTE

- Pulling out the terminal block forcefully without pushing the open/close button all the way down may damage the terminal block.
- Use a small flathead screwdriver (Tip thickness: 0.4mm/tip width: 2.5mm).
If a flathead screwdriver with a narrow tip is used, terminal block may be damaged.

Introduced products (as of January 2010)

Product	Type	Manufacturer
Flathead screwdriver	SZF 0- 0,4 x 2,5	Phoenix Contact Co.,Ltd.

- Place the flathead screwdriver vertical to the open/close button. In case the blade tip slips, it may cause to damage of inverter or injury.

(3) Control circuit common terminals (SD, SE)

Terminals SD and SE are common terminals for I/O signals. (Both common terminals are isolated from each other.) Do not earth them.

Terminal SD is a common terminal for the 24V external power supply terminal (+24). The open collector circuit is isolated from the internal control circuit by photocoupler.

Terminal SE is a common terminal for the open collector output terminal (Y0). The contact input circuit is isolated from the internal control circuit by photocoupler.

(4) Wiring instructions

- 1) It is recommended to use the cables of 0.3mm² to 0.75mm² gauge for connection to the control circuit terminals.
- 2) The maximum wiring length should be 30m.
- 3) Do not short across terminals +24 and SD. It may cause a failure to the external power supply.
- 4) Use shielded or twisted cables for connection to the control circuit terminals and run them away from the main and power circuits (including the 200V relay sequence circuit).

2.3.3 Connecting the 24V external power supply

CC-Link communication between the master module and the inverter can be continued while the main power circuit is OFF if the 24V external power supply is connected across terminals +24 and SD. When the main circuit power supply is turned ON, the power supply changes from the 24V external power supply to the main circuit power supply.

- (1) Specification of the applied 24V external power supply
 - Input voltage 23.5 to 26.5VDC
 - Input current 0.7A or less
- (2) Confirming the 24V external power supply
 - "EV" flickers in the monitor display on the operation panel while the 24V external power is being supplied. The 24V external power supply operation signal (EV) is also output. For the EV signal, assign the function to the terminal Y0 or a virtual terminal of CC-Link communication by setting "68 (positive logic) or 168 (negative logic)" in Pr. 190 to Pr. 192 or Pr. 313 to Pr. 315 (Output terminal function selection).

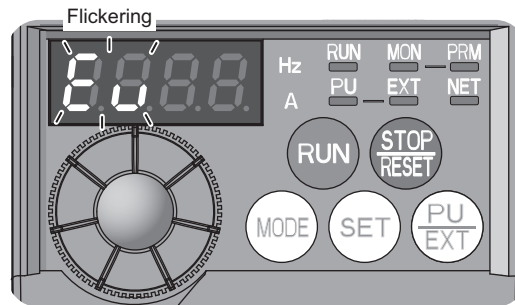

- (3) Function of the 24V external power supply operation
 - When the main power supply is turned ON during the 24V external power supply operation, a reset is performed in the inverter, then the power supply changes to the main circuit power supply. During the reset operation in the inverter, the inverter cannot be controlled through the CC-Link communication.
 - The operation stops when the power supply changes to the 24V external power supply from the main circuit power supply regardless of the operating status (in a stop, in running, in automatic restart after instantaneous power failure, in offline tuning, in main circuit capacitor life measurement).
 - All start signals (STF signal, STR signal, and  on the operation panel) are invalid during the 24V external power supply operation.
 - Faults history and parameters can be read and parameters can be written (when the parameter write from the operation panel is enabled) using the operation panel keys.
 - The safety stop function is also valid during the 24V external power supply operation. When the safety stop function is active, however, "SA" is not displayed because "EV" is displayed. The "EV" display has priority over the "SA" display.
 - The following items can be monitored during the 24V external power supply operation:
Frequency setting, output current peak value*, converter output voltage peak value*, cumulative energization time, actual operation time*, cumulative power*, PID set point, PID measured value, PID deviation, and cumulative power 2* (dedicated to CC-Link communication)
* The monitored data is not updated after the power supply is changed from the main circuit power supply.
(Refer to page 176 for the details of each monitor.)
 - The valid signals when the 24V external power supply is ON are EV, SAFE, SAFE2, Y90, Y91, Y95, REM, LF, and ALM. (Other signals are OFF.)
(Refer to page 167 for the detail of each signal.)
 - The alarms, which have occurred when the main circuit power supply is ON, continue to be output after the power supply is changed to the 24V external power supply. Perform the inverter reset to reset the alarms.
 - The retry function is invalid for all alarms when the 24V external power supply is ON.
 - If the power supply changes from the main circuit power supply to the 24V external power supply while measuring the main circuit capacitor's life, the measurement completes after the power supply changes back to the main circuit power supply (Pr.259 = "3").



NOTE

- When the 24V external power supply is input while the main circuit power supply is OFF, the CC-Link communication is enabled, but the inverter operation is disabled.
- Inrush current higher than the value described in (1) may flow at a power-ON. Confirm that the power supply and other devices are not affected by the inrush current and the voltage drop caused by it.
- When the wiring length between the external power supply and the inverter is long, the voltage often drops. Select the appropriate wiring size and length to keep the voltage in the rated input voltage range.
- In a serial connection of several inverters, the current increases when it flows through the inverter wiring near the power supply. The increase of the current causes voltage to drop further. When connecting different inverters to different power supplies, use the inverters after confirming that the input voltage of each inverter is within the rated input voltage range.
- "E.SAF" may appear when the start-up time of the 24V power supply is too long in the 24V external power supply operation.

2.3.4 Safety stop function Ver.UP

(1) Description of the function

The terminals related to the safety stop function are shown below.

Terminal Symbol		Description	
S1 *1		For input of safety stop channel 1.	Between S1 and PC / S2 and PC Open: In safety stop state. Short: Other than safety stop state.
S2 *1		For input of safety stop channel 2.	
PC *1		Common terminal for terminal S1 and S2.	
Y0 or virtual terminal of CC-Link communication*2	SAFE signal *3	Outputs the safety stop status. The signal is output when inverter output is shut off due to the safety stop function.	OFF: Drive enabled or drive stop (at an internal safety circuit failure*5) ON: Drive stop (no internal safety circuit failure*5)
	SAFE2 signal *4	Outputs when an alarm or failure is detected. The signal is output when no internal safety circuit failure*5 exists.	OFF: Internal safety circuit failure*5 ON : No internal safety circuit failure*5
SE		Common terminal for open collector outputs (terminal Y0)	

- *1 In the initial status, terminals S1 and S2 are shorted with terminal PC by shortening wire. Remove the shortening wire and connect the safety relay module when using the safety stop function.
 - *2 Inverter running (RUN signal) is assigned to the terminal Y0 in the initial status. (Refer to page 167)
 - *3 To use the SAFE signal, set "80 (positive logic) or 180 (negative logic)" in any of Pr. 190 to Pr. 192 or Pr. 313 to Pr. 315 (Output terminal function selection) to assign the function. (Refer to page 167)
 - *4 To use the SAFE2 signal, set "81 (positive logic) or 181 (negative logic)" in any of Pr. 190 to Pr. 192 or Pr. 313 to Pr. 315 (Output terminal function selection) to assign the function. (Refer to page 167)
 - *5 At an internal safety circuit failure, one of E.SAF, E.6, E.7, and E.CPU is displayed on the operation panel.
- Ver.UP**Specifications differ according to the date assembled. Refer to page 275 to check the SERIAL number.



NOTE

- Hold the ON or OFF status for 2ms or longer to input signal to terminal S1 or S2. Signal input shorter than 2ms is not recognized.
- Use SAFE signal to monitor safety stop status. SAFE signal cannot be used as safety stop input signal to other devices (other than the safety relay module).
- SAFE 2 signal can only be used to output an alarm or to prevent restart of an inverter. The signal cannot be used as safety stop input signal to other devices.

(2) Wiring connection diagram

To prevent restart at fault occurrence, connect terminals Y0 (SAFE 2 signal) and SE to terminals XS0 and XS1, which are the feedback input terminals of the safety relay module.

By setting Pr. 190 RX2 (terminal Y0) function selection = "81 (SAFE2 signal)", terminal RUN is turned OFF at fault occurrence.

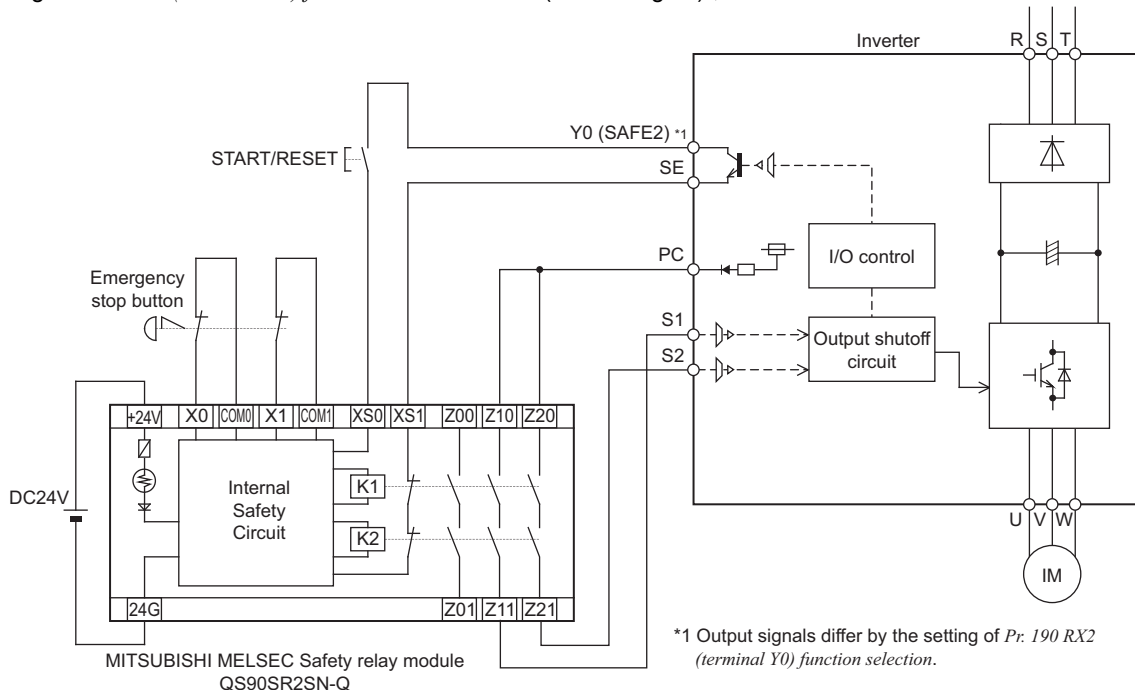

NOTE

- Changing the terminal assignment of SAFE or SAFE2 signal using Pr. 190 RX2 (terminal Y0) function selection may affect the other functions. Set parameters after confirming the function of terminal Y0.

(3) Safety stop function operation

Input power	Input signal		Internal safety circuit*1	Output signal		Inverter operation enable signal
	S1-PC	S2-PC		SAFE*3	SAFE2*3	
OFF	—	—	—	OFF	OFF	Output shutoff (Safe state)
ON	Short	Short	No failure	OFF	ON	Drive enabled
			Failure	OFF	OFF	Output shutoff (Safe state)
	Open	Open	No failure *2	ON	ON	Output shutoff (Safe state)
			Failure	OFF	OFF	Output shutoff (Safe state)
	Short	Open	Failure	OFF	OFF	Output shutoff (Safe state)
	Open	Short	Failure	OFF	OFF	Output shutoff (Safe state)

*1 At an internal safety circuit failure, one of E.SAF, E.6, E.7, and E.CPU is displayed on the operation panel.

*2 SA is displayed when both of the S1 and S2 signals are in open status and no internal safety circuit failure exists.

*3 ON: Transistor used for an open collector output is conducted.

OFF: Transistor used for an open collector output is not conducted.

For more details, refer to *the Safety stop function instruction manual (BCN-A211508-004)*. (Refer to the front cover of *the Instruction Manual (Basic)* for how to obtain the manual.)

2.4 Connection of stand-alone option unit

The inverter accepts a variety of stand-alone option units as required.

Incorrect connection will cause inverter damage or accident. Connect and operate the option unit carefully in accordance with the corresponding option unit manual.

2.4.1 Connection of a dedicated external brake resistor (MRS type, MYS type, FR-ABR) (0.4K or higher)

Install a dedicated brake resistor (MRS type, MYS type, FR-ABR) outside when the motor is made to run by the load, quick deceleration is required, etc. Connect a dedicated brake resistor (MRS type, MYS type, FR-ABR) to terminal P/+ and PR. (For the locations of terminal P/+ and PR, refer to the terminal block layout (page 15).)

Set parameters below.

Connected Brake Resistor	Pr. 30 Regenerative function selection Setting	Pr. 70 Special regenerative brake duty Setting		
MRS type, MYS type	0 (initial value)	—		
MYS type (used at 100% torque / 6%ED)	1	6%	Refer to page 155	
FR-ABR	1	7.5K or less		10%
		11K or more		6%

FR-E720-0.4KNC, 0.75KNC FR-E720S-0.4KNC	FR-E720-1.5KNC to 3.7KNC FR-E740-0.4KNC to 3.7KNC FR-E720S-0.75KNC to 2.2KNC
Connect the brake resistor across terminals P/+ and PR.	Connect the brake resistor across terminals P/+ and PR.
FR-E720-5.5KNC to 15KNC	FR-E740-5.5KNC to 15KNC
Connect the brake resistor across terminals P/+ and PR.	Connect the brake resistor across terminals P/+ and PR.

*1 Do not remove the jumper across terminals P/+ and P1 except when connecting a DC reactor.

*2 The shape of jumper differs according to capacities.

It is recommended to configure a sequence, which shuts off power in the input side of the inverter by the external thermal relay as shown below, to prevent overheat and burnout of the brake resistor (MRS type, MYS type) and high duty brake resistor (FR-ABR) in case the regenerative brake transistor is damaged. (The brake resistor cannot be connected to the 0.1K and 0.2K.)

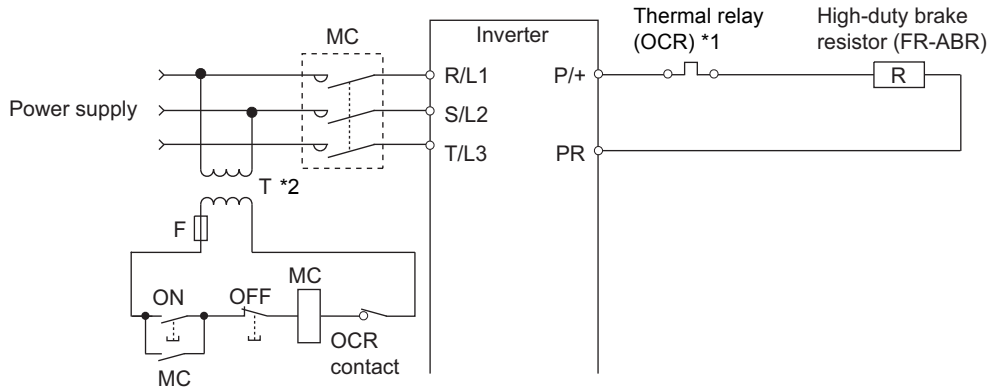

- *1 Refer to the table below for the type number of each capacity of thermal relay and the diagram below for the connection. (Always install a thermal relay when using a brake resistor whose capacity is 11K or higher)
- *2 When the power supply is 400V class, install a stepdown transformer.

Power Supply Voltage	Brake Resistor	Thermal Relay Type (Mitsubishi product)	Contact Rating
200V	MRS120W200	TH-N20CXHZ-0.7A	110VAC 5A, 220VAC 2A(AC11 class) 110VDC 0.5A, 220VDC 0.25A(DC11class)
	MRS120W100	TH-N20CXHZ-1.3A	
	MRS120W60	TH-N20CXHZ-2.1A	
	MRS120W40	TH-N20CXHZ-3.6A	
	MYS220W50 (two units in parallel)	TH-N20CXHZ-5A	

Power Supply Voltage	High-duty Brake Resistor	Thermal Relay Type (Mitsubishi product)	Contact Rating
200V	FR-ABR-0.4K	TH-N20CXHZ-0.7A	110VAC 5A, 220VAC 2A(AC11 class) 110VDC 0.5A, 220VDC 0.25A(DC11 class)
	FR-ABR-0.75K	TH-N20CXHZ-1.3A	
	FR-ABR-2.2K	TH-N20CXHZ-2.1A	
	FR-ABR-3.7K	TH-N20CXHZ-3.6A	
	FR-ABR-5.5K	TH-N20CXHZ-5A	
	FR-ABR-7.5K	TH-N20CXHZ-6.6A	
	FR-ABR-11K	TH-N20CXHZ-11A	
	FR-ABR-15K	TH-N20CXHZ-11A	
400V	FR-ABR-H0.4K	TH-N20CXHZ-0.24A	110VAC 5A, 220VAC 2A(AC11 class) 110VDC 0.5A, 220VDC 0.25A(DC11 class)
	FR-ABR-H0.75K	TH-N20CXHZ-0.35A	
	FR-ABR-H1.5K	TH-N20CXHZ-0.9A	
	FR-ABR-H2.2K	TH-N20CXHZ-1.3A	
	FR-ABR-H3.7K	TH-N20CXHZ-2.1A	
	FR-ABR-H5.5K	TH-N20CXHZ-2.5A	
	FR-ABR-H7.5K	TH-N20CXHZ-3.6A	
	FR-ABR-H11K	TH-N20CXHZ-6.6A	
FR-ABR-H15K	TH-N20CXHZ-6.6A		

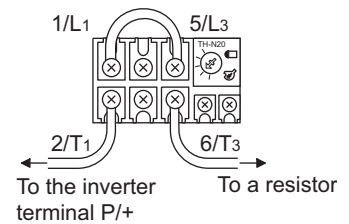

NOTE

- The brake resistor connected should only be the dedicated brake resistor.
- Perform wiring and operation according to the Instruction Manual of each option unit.
- Brake resistor can not be used with the brake unit, high power factor converter, power supply regeneration converter, etc.
- Do not use the brake resistor (MRS type, MYS type) with a lead wire extended.
- Do not connect a resistor directly to the terminals P/+ and N/-. This could cause a fire.

2.4.2 Connection of the brake unit (FR-BU2)

Connect the brake unit (FR-BU2(-H)) as shown below to improve the braking capability at deceleration. If the transistors in the brake unit should become faulty, the resistor can be unusually hot. To prevent unusual overheat and fire, install a magnetic contactor on the inverter's input side to configure a circuit so that a current is shut off in case of fault.

(1) Connection example with the GRZG type discharging resistor

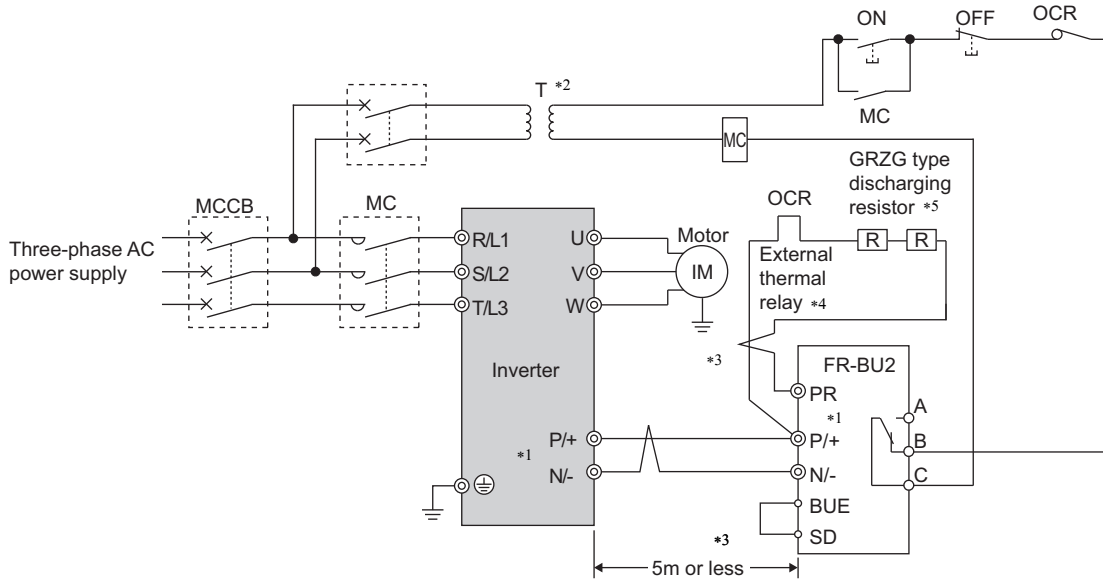

- *1 Connect the inverter terminals (P/+ and N/-) and brake unit (FR-BU2) terminals so that their terminal names match with each other.
(Incorrect connection will damage the inverter and brake unit.)
- *2 When the power supply is 400V class, install a step-down transformer.
- *3 The wiring distance between the inverter, brake unit (FR-BU2) and discharging resistor should be within 5m. Even when the wiring is twisted, the cable length must not exceed 10m.
- *4 It is recommended to install an external thermal relay to prevent overheat of discharging resistors.
- *5 Refer to FR-BU2 manual for connection method of discharging resistor.

<Recommended external thermal relay>

Brake Unit	Discharging Resistor	Recommended External Thermal Relay
FR-BU2-1.5K	GZG 300W-50Ω (one)	TH-N20CXHZ 1.3A
FR-BU2-3.7K	GRZG 200-10Ω (three in series)	TH-N20CXHZ 3.6A
FR-BU2-7.5K	GRZG 300-5Ω (four in series)	TH-N20CXHZ 6.6A
FR-BU2-15K	GRZG 400-2Ω (six in series)	TH-N20CXHZ 11A
FR-BU2-H7.5K	GRZG 200-10Ω (six in series)	TH-N20CXHZ 3.6A
FR-BU2-H15K	GRZG 300-5Ω (eight in series)	TH-N20CXHZ 6.6A

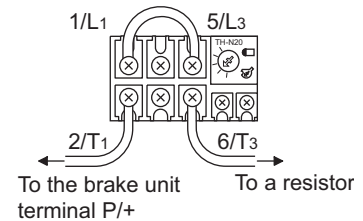

NOTE

- Set "1" in Pr. 0 Brake mode selection of the FR-BU2 to use GRZG type discharging resistor.
- Do not remove the jumper across terminals P/+ and P1 except when connecting a DC reactor.

(2) Connection example with the FR-BR(-H) type resistor

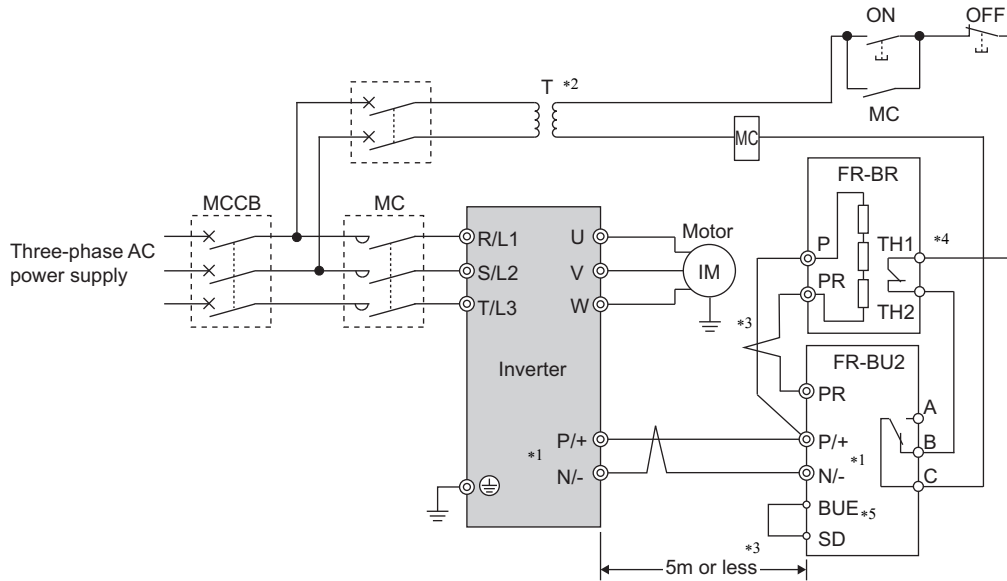

- *1 Connect the inverter terminals (P/+ and N/-) and brake unit (FR-BU2) terminals so that their terminal names match with each other.
(Incorrect connection will damage the inverter and brake unit.)
- *2 When the power supply is 400V class, install a step-down transformer.
- *3 The wiring distance between the inverter, brake unit (FR-BU2) and resistor unit (FR-BR) should be within 5m. Even when the wiring is twisted, the cable length must not exceed 10m.
- *4 The contact between TH1 and TH2 is closed in the normal status and is open at a fault.
- *5 A jumper is connected across BUE and SD in the initial status.



NOTE

- Do not remove the jumper across terminals P/+ and P1 except when connecting a DC reactor.

2.4.3 Connection of the DC reactor (FR-HEL)

When using the DC reactor (FR-HEL), connect it across terminals P/+ and P1.

In this case, the jumper connected across terminals P/+ and P1 must be removed. Otherwise, the reactor will not exhibit its performance.

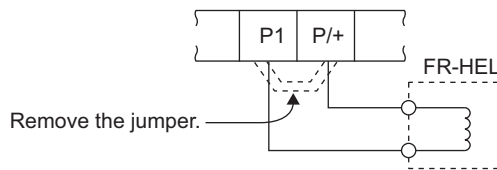

NOTE

- The wiring distance should be within 5m.
- The size of the cables used should be equal to or larger than that of the power supply cables (R/L1, S/L2, T/L3). (Refer to page 17)

MEMO

3 PRECAUTIONS FOR USE OF THE INVERTER

This chapter explains the "PRECAUTIONS FOR USE OF THE INVERTER" for use of this product.

Always read the instructions before using the equipment.

3.1	EMC and leakage currents	32
3.2	Installation of power factor improving reactor	39
3.3	Power-OFF and magnetic contactor (MC)	40
3.4	Inverter-driven 400V class motor	41
3.5	Precautions for use of the inverter	42
3.6	Failsafe of the system which uses the inverter	44

1

2

3

4

5

6

7

8

3.1 EMC and leakage currents

3.1.1 Leakage currents and countermeasures

Capacitances exist between the inverter I/O cables, other cables and earth and in the motor, through which a leakage current flows. Since its value depends on the static capacitances, carrier frequency, etc., low acoustic noise operation at the increased carrier frequency of the inverter will increase the leakage current. Therefore, take the following measures. Select the earth leakage current breaker according to its rated sensitivity current, independently of the carrier frequency setting.

(1) To-earth (ground) leakage currents

Leakage currents may flow not only into the inverter's own line but also into the other lines through the earthing (grounding) cable, etc. These leakage currents may operate earth (ground) leakage circuit breakers and earth leakage relays unnecessarily.

●Suppression technique

- If the carrier frequency setting is high, decrease the *Pr. 72 PWM frequency selection* setting. Note that motor noise increases. Selecting *Pr. 240 Soft-PWM operation selection* makes the sound inoffensive.
- By using earth leakage circuit breakers designed for harmonic and surge suppression in the inverter's own line and other line, operation can be performed with the carrier frequency kept high (with low noise).

●To-earth (ground) leakage currents

- Take caution as long wiring will increase the leakage current. Decreasing the carrier frequency of the inverter reduces the leakage current.
- Increasing the motor capacity increases the leakage current. The leakage current of the 400V class is larger than that of the 200V class.

(2) Line-to-line leakage currents

Harmonics of leakage currents flowing in static capacitances between the inverter output cables may operate the external thermal relay unnecessarily. When the wiring length is long (50m or more) for the 400V class small-capacity model (7.5kW(SC) or less), the external thermal relay is likely to operate unnecessarily because the ratio of the leakage current to the rated motor current increases.

●Line-to-line leakage current data example (200V class)

Motor Capacity (kW)	Rated Motor Current (A)	Leakage Current (mA) *	
		Wiring length 50m	Wiring length 100m
0.4	1.8	310	500
0.75	3.2	340	530
1.5	5.8	370	560
2.2	8.1	400	590
3.7	12.8	440	630
5.5	19.4	490	680
7.5	25.6	535	725

- Motor: SF-JR 4P
- Carrier frequency: 14.5kHz
- Used wire: 2mm², 4 cores
Cabtyre cable

*The leakage currents of the 400V class are about twice as large.

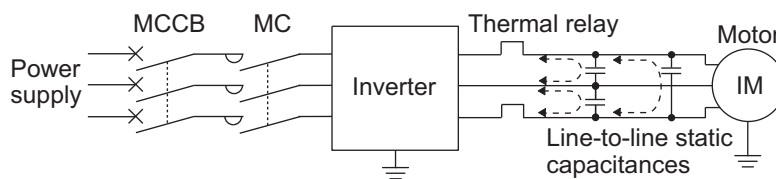

Line-to-line leakage currents path

●Measures

- Use *Pr. 9 Electronic thermal O/L relay*.
- If the carrier frequency setting is high, decrease the *Pr. 72 PWM frequency selection* setting. Note that motor noise increases. Selecting *Pr. 240 Soft-PWM operation selection* makes the sound inoffensive. To ensure that the motor is protected against line-to-line leakage currents, it is recommended to use a temperature sensor to directly detect motor temperature.

●Installation and selection of moulded case circuit breaker

Install a moulded case circuit breaker (MCCB) on the power receiving side to protect the wiring of the inverter input side. Select the MCCB according to the inverter input side power factor (which depends on the power supply voltage, output frequency and load). Especially for a completely electromagnetic MCCB, one of a slightly large capacity must be selected since its operation characteristic varies with harmonic currents. (Check it in the data of the corresponding breaker.) As an earth leakage current breaker, use the Mitsubishi earth leakage current breaker designed for harmonics and surge suppression.

(3) Selection of rated sensitivity current of earth (ground) leakage current breaker

When using the earth leakage current breaker with the inverter circuit, select its rated sensitivity current as follows, independently of the PWM carrier frequency.

- Breaker designed for harmonic and surge suppression
 Rated sensitivity current:
 $I_{\Delta n} \geq 10 \times (I_{g1} + I_{gn} + I_{gi} + I_{g2} + I_{gm})$
- Standard breaker
 Rated sensitivity current:
 $I_{\Delta n} \geq 10 \times \{I_{g1} + I_{gn} + I_{gi} + 3 \times (I_{g2} + I_{gm})\}$

- I_{g1}, I_{g2} : Leakage currents in wire path during commercial power supply operation
- I_{gn} : Leakage current of inverter input side noise filter
- I_{gm} : Leakage current of motor during commercial power supply operation
- I_{gi} : Leakage current of inverter unit

Example of leakage current of cable path per 1km during the commercial power supply operation when the CV cable is routed in metal conduit (200V 60Hz)

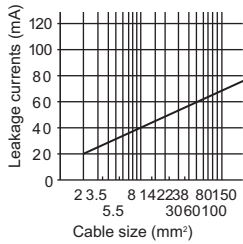

Example of leakage current of three-phase induction motor during the commercial power supply operation (200V 60Hz)

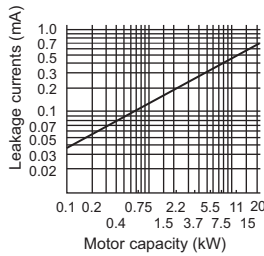

Example of leakage current per 1km during the commercial power supply operation when the CV cable is routed in metal conduit (Three-phase three-wire delta connection 400V/60Hz)

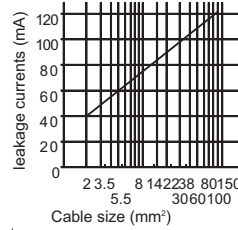

Example of leakage current of three-phase induction motor during the commercial power supply operation (Totally-enclosed fan-cooled type motor 400V/60Hz)

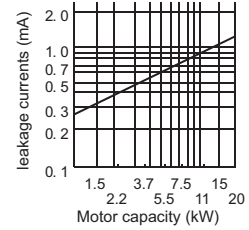

For "Δ" connection, the amount of leakage current is approx. 1/3 of the above value.

<Example>

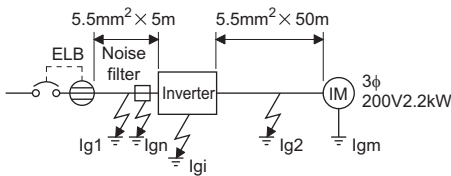

	Breaker Designed for Harmonic and Surge Suppression	Standard Breaker
Leakage current I_{g1} (mA)	$33 \times \frac{5m}{1000m} = 0.17$	
Leakage current I_{gn} (mA)	0 (without noise filter)	
Leakage current I_{gi} (mA)	1	
Leakage current I_{g2} (mA)	$33 \times \frac{50m}{1000m} = 1.65$	
Motor leakage current I_{gm} (mA)		0.18
Total leakage current (mA)	3.00	6.66
Rated sensitivity current (mA) ($\geq I_g \times 10$)	30	100



NOTE

- Install the earth leakage breaker (ELB) on the input side of the inverter.
- In the Δ connection earthed-neutral system, the sensitivity current is blunt against an earth (ground) fault in the inverter output side. Earthing (Grounding) must conform to the requirements of national and local safety regulations and electrical codes. (NEC section 250, IEC 536 class 1 and other applicable standards)
- When the breaker is installed on the output side of the inverter, it may be unnecessarily operated by harmonics even if the effective value is less than the rating.
 In this case, do not install the breaker since the eddy current and hysteresis loss will increase, leading to temperature rise.
- General products indicate the following models. BV-C1, BC-V, NVB, NV-L, NV-G2N, NV-G3NA, NV-2F earth leakage relay (except NV-ZHA), NV with AA neutral wire open-phase protection
 The other models are designed for harmonic and surge suppressionNV-C/NV-S/MN series, NV30-FA, NV50-FA, BV-C2, earth leakage alarm breaker (NF-Z), NV-ZHA, NV-H

3 PRECAUTIONS FOR USE OF THE INVERTER

3.1.2 EMC measures

Some electromagnetic noises enter the inverter to malfunction it and others are radiated by the inverter to malfunction peripheral devices. Though the inverter is designed to have high immunity performance, it handles low-level signals, so it requires the following basic techniques. Also, since the inverter chops outputs at high carrier frequency, that could generate electromagnetic noises. If these electromagnetic noises cause peripheral devices to malfunction, EMI measures should be taken to suppress noises. These techniques differ slightly depending on EMI paths.

(1) Basic techniques

- Do not run the power cables (I/O cables) and signal cables of the inverter in parallel with each other and do not bundle them.
- Use twisted shield cables for the detector connecting and control signal cables and connect the sheathes of the shield cables to terminal SD.
- Earth (Ground) the inverter, motor, etc. at one point.

(2) Techniques to reduce electromagnetic noises that enter and malfunction the inverter (Immunity measures)

When devices that generate many electromagnetic noises (which use magnetic contactors, magnetic brakes, many relays, for example) are installed near the inverter and the inverter may be malfunctioned by electromagnetic noises, the following measures must be taken:

- Provide surge suppressors for devices that generate many electromagnetic noises to suppress electromagnetic noises.
- Fit data line filters (page 35) to signal cables.
- Earth (Ground) the shields of the detector connection and control signal cables with cable clamp metal.

(3) Techniques to reduce electromagnetic noises that are radiated by the inverter to malfunction peripheral devices (EMI measures)

Inverter-generated electromagnetic noises are largely classified into those radiated by the cables connected to the inverter and inverter main circuits (I/O), those electromagnetically and electrostatically induced to the signal cables of the peripheral devices close to the main circuit power supply, and those transmitted through the power supply cables.

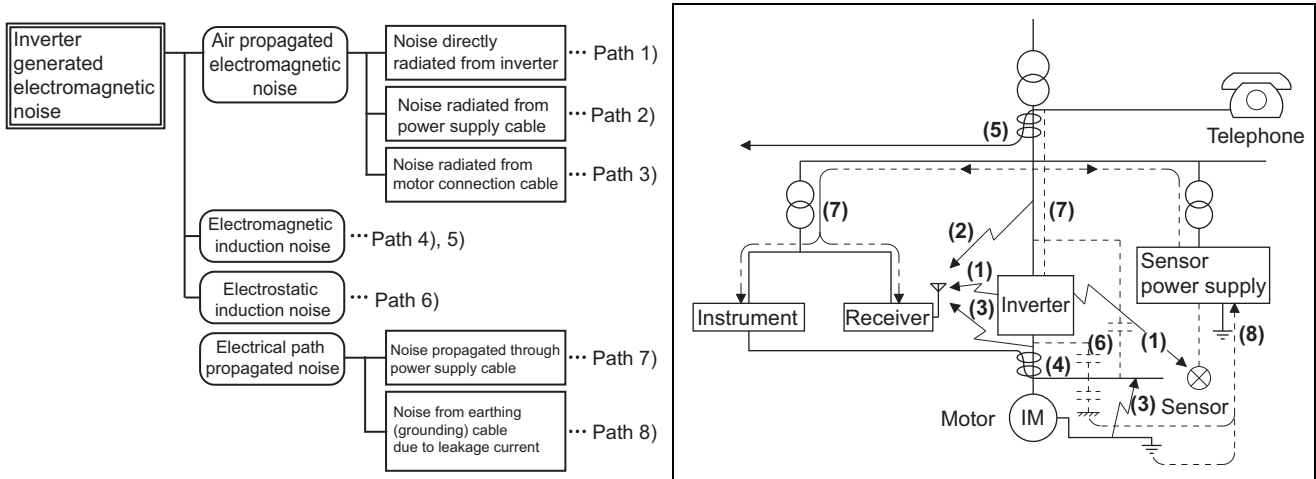

Propagation Path	Measures
(1)(2)(3)	<p>When devices that handle low-level signals and are liable to malfunction due to electromagnetic noises, e.g. instruments, receivers and sensors, are contained in the enclosure that contains the inverter or when their signal cables are run near the inverter, the devices may be malfunctioned by air-propagated electromagnetic noises. The following measures must be taken:</p> <ul style="list-style-type: none"> • Install easily affected devices as far away as possible from the inverter. • Run easily affected signal cables as far away as possible from the inverter and its I/O cables. • Do not run the signal cables and power cables (inverter I/O cables) in parallel with each other and do not bundle them. • Insert a line noise filter into I/O and capacitors between the input lines to suppress cable-radiated noises. • Use shield cables as signal cables and power cables and run them in individual metal conduits to produce further effects.
(4)(5)(6)	<p>When the signal cables are run in parallel with or bundled with the power cables, magnetic and static induction noises may be propagated to the signal cables to malfunction the devices and the following measures must be taken:</p> <ul style="list-style-type: none"> • Install easily affected devices as far away as possible from the inverter. • Run easily affected signal cables as far away as possible from the I/O cables of the inverter. • Do not run the signal cables and power cables (inverter I/O cables) in parallel with each other and do not bundle them. • Use shield cables as signal cables and power cables and run them in individual metal conduits to produce further effects.
(7)	<p>When the power supplies of the peripheral devices are connected to the power supply of the inverter in the same line, inverter-generated noises may flow back through the power supply cables to malfunction the devices and the following measures must be taken:</p> <ul style="list-style-type: none"> • Install the line noise filter (FR-BLF, FR-BSF01) to the power cables (output cable) of the inverter.
(8)	<p>When a closed loop circuit is formed by connecting the peripheral device wiring to the inverter, leakage currents may flow through the earthing (grounding) cable of the inverter to malfunction the device. In such a case, disconnection of the earthing (grounding) cable of the device may cause the device to operate properly.</p>

●Data line filter

Data line filter is effective as an EMC measure. Provide a data line filter for the detector cable, etc.

●EMC measures

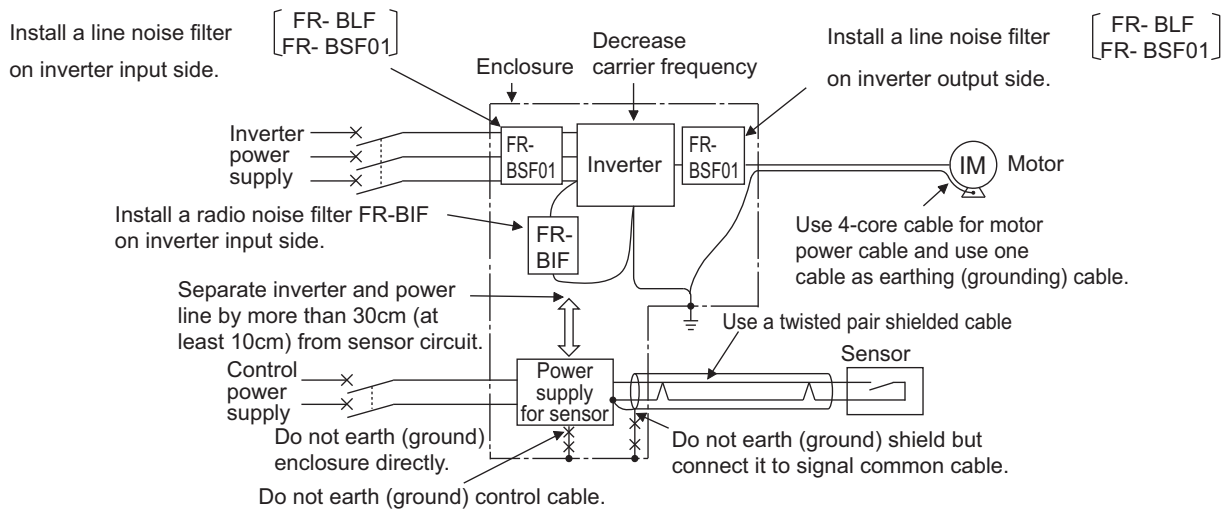

NOTE

• For compliance with the EU EMC directive, please refer to the *Instruction Manual (Basic)*.

3.1.3 Power supply harmonics

The inverter may generate power supply harmonics from its converter circuit to affect the power generator, power capacitor etc. Power supply harmonics are different from noise and leakage currents in source, frequency band and transmission path. Take the following countermeasure suppression techniques.

●The differences between harmonics and RF noises are indicated below:

Item	Harmonics	Noise
Frequency	Normally 40th to 50th degrees or less (up to 3kHz or less)	High frequency (several 10kHz to 1GHz order)
Environment	To-electric channel, power impedance	To-space, distance, wiring path
Quantitative understanding	Theoretical calculation possible	Random occurrence, quantitative grasping difficult
Generated amount	Nearly proportional to load capacity	Change with current variation ratio (larger as switching speed increases)
Affected equipment immunity	Specified in standard per equipment	Different depending on maker's equipment specifications
Suppression example	Provide reactor.	Increase distance.

●Suppression technique

The harmonic current generated from the inverter to the input side differs according to various conditions such as the wiring impedance, whether a reactor is used or not, and output frequency and output current on the load side.

For the output frequency and output current, we understand that they should be calculated in the conditions under the rated load at the maximum operating frequency.

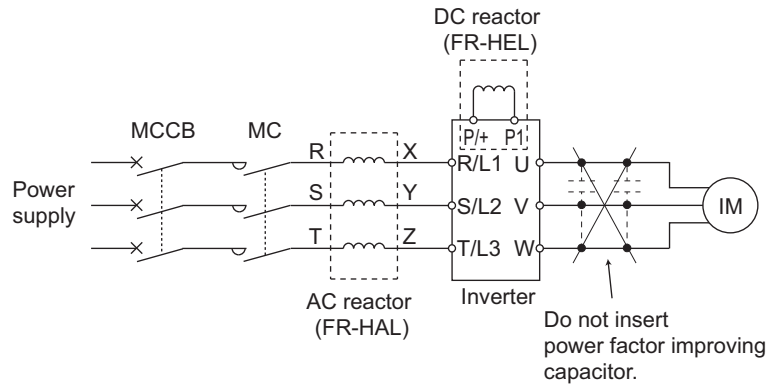

NOTE

The power factor improving capacitor and surge suppressor on the inverter output side may be overheated or damaged by the harmonic components of the inverter output. Also, since an excessive current flows in the inverter to activate overcurrent protection, do not provide a capacitor and surge suppressor on the inverter output side when the motor is driven by the inverter. For power factor improvement, install a reactor on the inverter input side or in the DC circuit.

3.1.4 Harmonic Suppression Guidelines in Japan

Harmonic currents flow from the inverter to a power receiving point via a power transformer. The Harmonic Suppression Guidelines was established to protect other consumers from these outgoing harmonic currents.

The three-phase 200V input specifications 3.7kW or lower (single-phase 200V power input model 2.2kW or lower are previously covered by "Harmonic Suppression Guidelines for Household Appliances and General-purpose Products" and other models are covered by "Harmonic Suppression Guidelines for Consumers Who Receive High Voltage or Special High Voltage". However, the transistorized inverter has been excluded from the target products covered by "Harmonic Suppression Guidelines for Household Appliances and General-purpose Products" in January 2004 and "Harmonic Suppression Guidelines for Household Appliances and General-purpose Products" was repealed on September 6, 2004.

All capacity and all models of general-purpose inverter used by specific consumers are covered by "Harmonic Suppression Guidelines for Consumers Who Receive High Voltage or Special High Voltage" (hereinafter referred to as "Specific Consumer Guidelines").

"Specific Consumer Guidelines"

This guideline sets forth the maximum values of harmonic currents outgoing from a high-voltage or especially high-voltage consumer who will install, add or renew harmonic generating equipment. If any of the maximum values is exceeded, this guideline requires that consumer to take certain suppression measures.

Table 1 Maximum Values of Outgoing Harmonic Currents per 1kW Contract Power

Received Power Voltage	5th	7th	11th	13th	17th	19th	23rd	Over 23rd
6.6kV	3.5	2.5	1.6	1.3	1.0	0.9	0.76	0.70
22kV	1.8	1.3	0.82	0.69	0.53	0.47	0.39	0.36
33kV	1.2	0.86	0.55	0.46	0.35	0.32	0.26	0.24

(1) Application for specific consumers

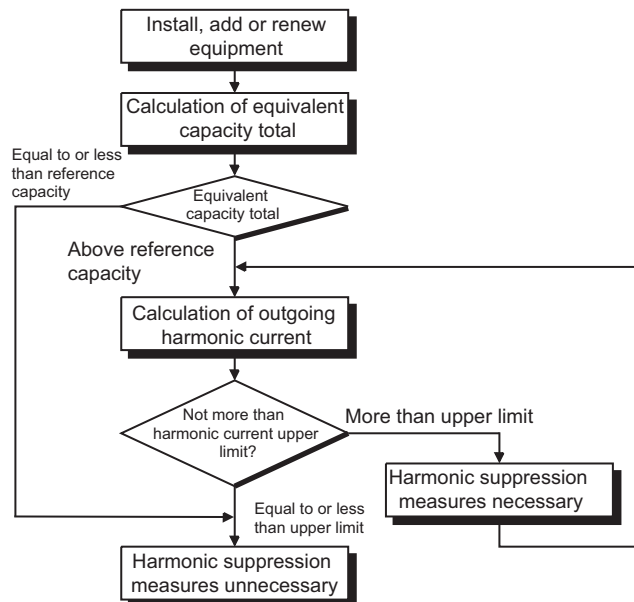

Table 2 Conversion Factors for FR-E700 Series

Class	Circuit Type	Conversion Factor (Ki)	
3	Three-phase bridge (Capacitor smoothing)	Without reactor	K31= 3.4
		With reactor (AC side)	K32 = 1.8
		With reactor (DC side)	K33 = 1.8
		With reactors (AC, DC sides)	K34 = 1.4
4	Single-phase bridge (Capacitor smoothing)	Without reactor	K41= 2.3
		With reactor (AC side)	K42 = 0.35 *

* K42=0.35 is a value when the reactor value is 20%. Since a 20% reactor is large and considered to be not practical, K42=1.67 is written as conversion factor for a 5% reactor in the technical data JEM-TR201 of The Japan Electrical Manufacturers' Association and this value is recommended for calculation for the actual practice.

Table 3 Equivalent Capacity Limits

Received Power Voltage	Reference Capacity
6.6kV	50kVA
22/33 kV	300kVA
66kV or more	2000kVA

Table 4 Harmonic Contents (Values at the fundamental current of 100%)

	Reactor	5th	7th	11th	13th	17th	19th	23rd	25th
Three-phase bridge (Capacitor smoothing)	Not used	65	41	8.5	7.7	4.3	3.1	2.6	1.8
	Used (AC side)	38	14.5	7.4	3.4	3.2	1.9	1.7	1.3
	Used (DC side)	30	13	8.4	5.0	4.7	3.2	3.0	2.2
	Used (AC, DC sides)	28	9.1	7.2	4.1	3.2	2.4	1.6	1.4
Single-phase bridge (Capacitor smoothing)	Not used	50	24	5.1	4.0	1.5	1.4	-	-
	Used (AC side) *	6.0	3.9	1.6	1.2	0.6	0.1	-	-

* The harmonic contents for "single-phase bridge/with reactor" in the table 4 are values when the reactor value is 20%. Since a 20% reactor is large and considered to be not practical, harmonic contents when a 5% reactor is used is written in the technical data JEM-TR201 of The Japan Electrical Manufacturers' Association and this value is recommended for calculation for the actual practice.

1) Calculation of equivalent capacity (P0) of harmonic generating equipment

The "equivalent capacity" is the capacity of a 6-pulse converter converted from the capacity of consumer's harmonic generating equipment and is calculated with the following equation. If the sum of equivalent capacities is higher than the limit in Table 3, harmonics must be calculated with the following procedure:

$$P0 = \sum(Ki \times Pi) \text{ [kVA]}$$

Ki: Conversion factor (refer to Table 2)

Pi: Rated capacity of harmonic generating equipment* [kVA]

i: Number indicating the conversion circuit type

* Rated capacity: Determined by the capacity of the applied motor and found in Table 5. It should be noted that the rated capacity used here is used to calculate generated harmonic amount and is different from the power supply capacity required for actual inverter drive.

2) Calculation of outgoing harmonic current

Outgoing harmonic current = fundamental wave current (value converted from received power voltage) × operation ratio × harmonic content

- Operation ratio: Operation ratio = actual load factor × operation time ratio during 30 minutes
- Harmonic content: Found in Table 4.

Table 5 Rated Capacities and Outgoing Harmonic Currents for Inverter Drive

Applicable Motor (kW)	Rated Current [A]		Fundamental Wave Current Converted from 6.6kV (mA)	Rated Capacity (kVA)	Outgoing Harmonic Current Converted from 6.6kV(mA) (No reactor, 100% operation ratio)							
	200V	400V			5th	7th	11th	13th	17th	19th	23rd	25th
0.4	1.61	0.81	49	0.57	31.85	20.09	4.165	3.773	2.107	1.519	1.274	0.882
0.75	2.74	1.37	83	0.97	53.95	34.03	7.055	6.391	3.569	2.573	2.158	1.494
1.5	5.50	2.75	167	1.95	108.6	68.47	14.20	12.86	7.181	5.177	4.342	3.006
2.2	7.93	3.96	240	2.81	156.0	98.40	20.40	18.48	10.32	7.440	6.240	4.320
3.7	13.0	6.50	394	4.61	257.1	161.5	33.49	30.34	16.94	12.21	10.24	7.092
5.5	19.1	9.55	579	6.77	376.1	237.4	49.22	44.58	24.90	17.95	15.05	10.42
7.5	25.6	12.8	776	9.07	504.4	318.2	65.96	59.75	33.37	24.06	20.18	13.97
11	36.9	18.5	1121	13.1	728.7	459.6	95.29	86.32	48.20	34.75	29.15	20.18
15	49.8	24.9	1509	17.6	980.9	618.7	128.3	116.2	64.89	46.78	39.24	27.16

3) Application of the guideline for specific consumers

If the outgoing harmonic current is higher than the maximum value per 1kW contract power × contract power, a harmonic suppression technique is required.

4) Harmonic suppression techniques

No.	Item	Description
1	Reactor installation (FR-HAL, FR-HEL)	Install an AC reactor (FR-HAL) on the AC side of the inverter or a DC reactor (FR-HEL) on its DC side or both to suppress outgoing harmonic currents.
2	Installation of power factor improving capacitor	When used with a series reactor, the power factor improving capacitor has an effect of absorbing harmonic currents.
3	Transformer multi-phase operation	Use two transformers with a phase angle difference of 30° as in Δ - Δ , Δ - Δ combination to provide an effect corresponding to 12 pulses, reducing low-degree harmonic currents.
4	Passive filter (AC filter)	A capacitor and a reactor are used together to reduce impedances at specific frequencies, producing a great effect of absorbing harmonic currents.
5	Active filter (Active filter)	This filter detects the current of a circuit generating a harmonic current and generates a harmonic current equivalent to a difference between that current and a fundamental wave current to suppress a harmonic current at a detection point, providing a great effect of absorbing harmonic currents.

3.2 Installation of power factor improving reactor

When the inverter is connected near a large-capacity power transformer (500kVA or more) or when a power capacitor is to be switched over, an excessive peak current may flow in the power input circuit, damaging the converter circuit. To prevent this, always install an optional reactor (FR-HAL, FR-HEL).

● Three-phase power input

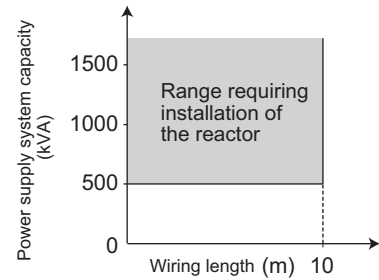
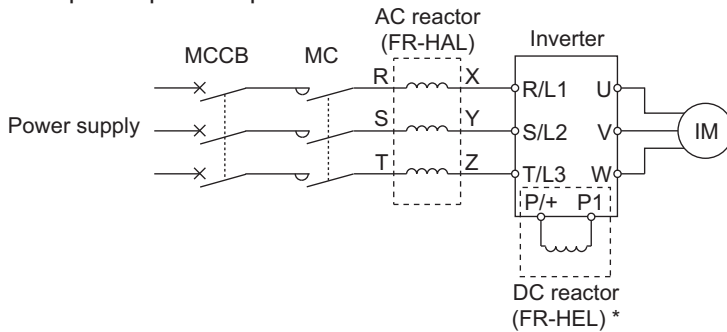

● Single-phase power input

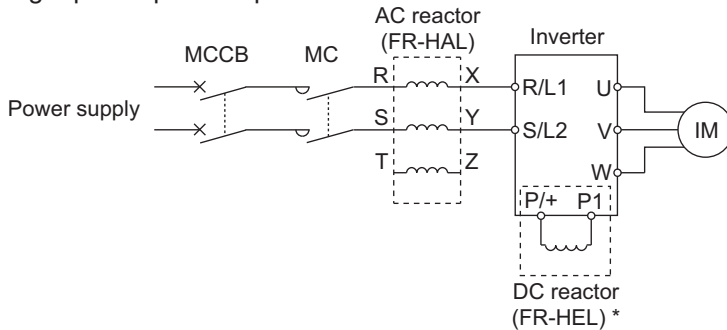

* When connecting the FR-HEL, remove the jumper across terminals P/+ and P1.
The wiring length between the FR-HEL and inverter should be 5m maximum and minimized.



REMARKS

- Use the same wire size as that of the power supply wire (R/L1, S/L2, T/L3). (Refer to page 17)

3.3 Power-OFF and magnetic contactor (MC)

(1) Inverter input side magnetic contactor (MC)

On the inverter input side, it is recommended to provide an MC for the following purposes.
(Refer to *page 4* for selection.)

- 1) To release the inverter from the power supply when the fault occurs or when the drive is not functioning (e.g. emergency stop operation). For example, MC avoids overheat or burnout of the brake resistor when heat capacity of the resistor is insufficient or brake regenerative transistor is damaged with short while connecting an optional brake resistor.
- 2) To prevent any accident due to an automatic restart at restoration of power after an inverter stop by a power failure
- 3) To separate the inverter from the power supply to ensure safe maintenance and inspection work.

The inverter's input side MC is used for the above purpose, select class JEM1038-AC3 MC for the inverter input side current when making an emergency stop during normal operation.

 **REMARKS**

- Since repeated inrush currents at power ON will shorten the life of the converter circuit (switching life is about 1,000,000 times), frequent starts and stops of the magnetic contactor must be avoided. Turn ON/OFF an input signal (forward/reverse rotation command) via CC-Link communication to start/stop the inverter.
- For the system, which requires a shutoff of the main power supply at an inverter failure, configure a sequence for the programmable controller to monitor inverter failures and turn OFF the magnetic contactor at a failure via CC-Link communication. (Use the Y91 signal to check the failure, which arises from a faulty inverter circuit or faulty connection. Refer to *page 170* for the details of the Y91 signal.)

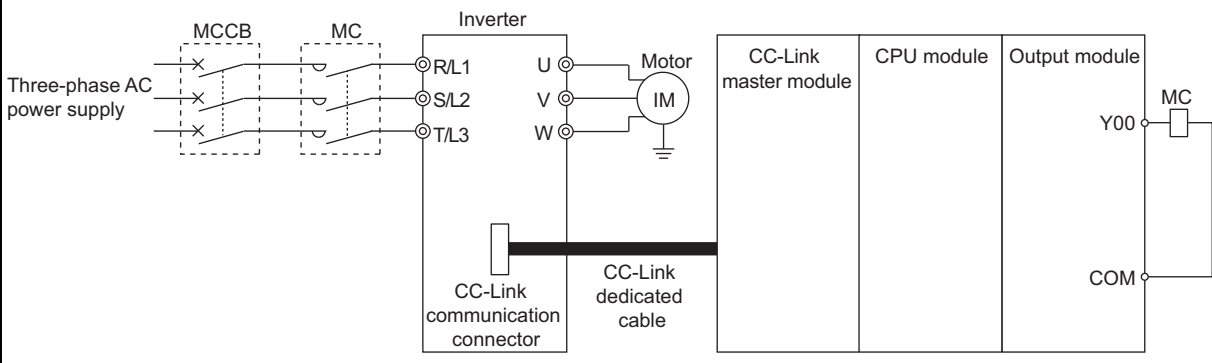

(2) Handling of inverter output side magnetic contactor

Switch the magnetic contactor between the inverter and motor only when both the inverter and motor are at a stop. When the magnetic contactor is turned ON while the inverter is operating, overcurrent protection of the inverter and such will activate. When an MC is provided for switching to the commercial power supply, for example, switch it ON/OFF after the inverter and motor have stopped.

3.4 Inverter-driven 400V class motor

In the PWM type inverter, a surge voltage attributable to wiring constants is generated at the motor terminals. Especially for a 400V class motor, the surge voltage may deteriorate the insulation. When the 400V class motor is driven by the inverter, consider the following measures:

●Measures

It is recommended to take either of the following measures:

(1) Rectifying the motor insulation and limiting the PWM carrier frequency according to the wiring length

For the 400V class motor, use an insulation-enhanced motor.

Specifically,

- 1) Specify the "400V class inverter-driven insulation-enhanced motor".
- 2) For the dedicated motor such as the constant-torque motor and low-vibration motor, use the "inverter-driven, dedicated motor".
- 3) Set *Pr. 72 PWM frequency selection* as indicated below according to the wiring length

	Wiring Length		
	50m or less	50m to 100m	exceeding 100m
<i>Pr. 72 PWM frequency selection</i>	15 (14.5kHz) or less	8 (8kHz) or less	2 (2kHz) or less

(2) Suppressing the surge voltage on the inverter side

Connect the surge voltage suppression filter (FR-ASF-H/FR-BMF-H) on the inverter output side.



NOTE

- For details of *Pr. 72 PWM frequency selection*, refer to page 192.
- For explanation of surge voltage suppression filter (FR-ASF-H/FR-BMF-H), refer to the manual of each option.

3.5 Precautions for use of the inverter

The FR-E700 series is a highly reliable product, but incorrect peripheral circuit making or operation/handling method may shorten the product life or damage the product.

Before starting operation, always recheck the following points.

- (1) **Use crimping terminals with insulation sleeve to wire the power supply and motor.**
- (2) **Application of power to the output terminals (U, V, W) of the inverter will damage the inverter. Never perform such wiring.**
- (3) **After wiring, wire offcuts must not be left in the inverter.**

Wire offcuts can cause an alarm, failure or malfunction. Always keep the inverter clean.
When drilling mounting holes in an enclosure etc., take care not to allow chips and other foreign matter to enter the inverter.
- (4) **Use cables of the size to make a voltage drop 2% maximum.**

If the wiring distance is long between the inverter and motor, a main circuit cable voltage drop will cause the motor torque to decrease especially at the output of a low frequency.
Refer to page 17 for the recommended wire sizes.
- (5) **The overall wiring length should be 500m maximum.**

Especially for long distance wiring, the fast-response current limit function may decrease or the equipment connected to the secondary side may malfunction or become faulty under the influence of a charging current due to the stray capacity of the wiring. Therefore, note the overall wiring length. (*Refer to page 19*)
- (6) **Electromagnetic wave interference**

The input/output (main circuit) of the inverter includes high frequency components, which may interfere with the communication devices (such as AM radios) used near the inverter. In this case, install options among the radio noise filter FR-BIF (for use in the input side only), and the line noise filter FR-BSF01/FR-BLF to minimize the interference.
- (7) **Do not install a power factor correction capacitor, surge suppressor or capacitor type filter on the inverter output side.**

This will cause the inverter to trip or the capacitor and surge suppressor to be damaged. If any of the above devices are connected, immediately remove them. (When using radio noise filter (FR-BIF) for single-phase power input model, make sure of secure insulation of T/L3-phase, and connect to the input side of the inverter.)
- (8) **For some short time after the power is switched OFF, a high voltage remains in the smoothing capacitor.**

When accessing the inverter for inspection, wait for at least 10 minutes after the power supply has been switched OFF, and then make sure that the voltage across the main circuit terminals P/+ and N/- of the inverter is not more than 30VDC using a tester, etc. The capacitor is charged with high voltage for some time after power OFF and it is dangerous.
- (9) **If "EV" is displayed on the operation panel of the safety stop function model, turn off the 24V external power supply before wiring and inspection.**
- (10) **A short circuit or earth (ground) fault on the inverter output side may damage the inverter modules.**
 - Fully check the insulation resistance of the circuit prior to inverter operation since repeated short circuits caused by peripheral circuit inadequacy or an earth (ground) fault caused by wiring inadequacy or reduced motor insulation resistance may damage the inverter modules.
 - Fully check the to-earth (ground) insulation and phase to phase insulation of the inverter output side before power-ON. Especially for an old motor or use in hostile atmosphere, securely check the motor insulation resistance etc.
- (11) **Do not use the inverter input side magnetic contactor to start/stop the inverter.**

Since repeated inrush currents at power ON will shorten the life of the converter circuit (switching life is about 1,000,000 times), frequent starts and stops of the MC must be avoided. Always use the start signal (ON/OFF of STF and STR signals) to start/stop the inverter. (*Refer to page 40*)

(12) Across terminals P/+ and PR, connect only an external regenerative brake discharging resistor.

Do not connect a mechanical brake.

The brake resistor can not be connected to the 0.1K or 0.2K. Leave terminals P/+ and PR open.

Also, never short between these terminals.

(13) Do not apply a voltage higher than the permissible voltage to the inverter I/O signal circuits.

Application of a voltage higher than the permissible voltage to the inverter I/O signal circuits or opposite polarity may damage the I/O devices.

(14) Provide electrical and mechanical interlocks for MC1 and MC2 which are used for bypass operation.

When the wiring is incorrect and if there is a bypass operation circuit as shown right, the inverter will be damaged when the power supply is connected to the inverter U, V, W terminals, due to arcs generated at the time of switch-over or chattering caused by a sequence error.

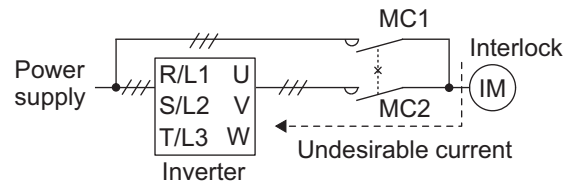

(15) If the machine must not be restarted when power is restored after a power failure, provide a magnetic contactor in the inverter's input side and also make up a sequence which will not switch ON the start signal.

If the start signal (start switch) remains ON after a power failure, the inverter will automatically restart as soon as the power is restored.

(16) Inverter input side magnetic contactor (MC)

On the inverter input side, connect a MC for the following purposes. (Refer to page 4 for selection.)

- 1) To release the inverter from the power supply when a fault occurs or when the drive is not functioning (e.g. emergency stop operation). For example, MC avoids overheat or burnout of the brake resistor when heat capacity of the resistor is insufficient or brake regenerative transistor is damaged with short while connecting an optional brake resistor.
- 2) To prevent any accident due to an automatic restart at restoration of power after an inverter stop made by a power failure
- 3) To separate the inverter from the power supply to ensure safe maintenance and inspection work.

The inverter's input side MC is used for the above purpose, select class JEM1038-AC3 MC for the inverter input side current when making an emergency stop during normal operation.

(17) Handling of inverter output side magnetic contactor

Switch the magnetic contactor between the inverter and motor only when both the inverter and motor are at a stop. When the magnetic contactor is turned ON while the inverter is operating, overcurrent protection of the inverter and such will activate. When MC is provided for switching to the commercial power supply, for example, switch it ON/OFF after the inverter and motor have stopped.

(18) Instructions for overload operation

When performing operation of frequent start/stop of the inverter, rise/fall in the temperature of the transistor element of the inverter will repeat due to a repeated flow of large current, shortening the life from thermal fatigue. Since thermal fatigue is related to the amount of current, the life can be increased by reducing current at locked condition, starting current, etc. Decreasing current may increase the life. However, decreasing current will result in insufficient torque and the inverter may not start. Therefore, choose the inverter which has enough allowance for current (up to 2 rank larger in capacity).

(19) Make sure that the specifications and rating match the system requirements.

3.6 Failsafe of the system which uses the inverter

When a fault occurs, the inverter trips to output a fault signal. However, a fault output signal may not be output at an inverter fault occurrence when the detection circuit or output circuit fails, etc. Although Mitsubishi assures best quality products, provide an interlock which uses inverter status output signals to prevent accidents such as damage to machine when the inverter fails for some reason and at the same time consider the system configuration where failsafe from outside the inverter, without using the inverter, is enabled even if the inverter fails.

(1) Interlock method which uses the inverter status output signals

By providing interlocks, inverter fault can be detected. For the interlocks, use different status output signals of the inverter (virtual terminals of the CC-Link communication) in combinations shown below.

No.	Interlock Method	Check Method	Used Signals	Refer to Page
1)	Inverter protective function operation	Operation check of an alarm contact Circuit error detection by negative logic	Fault output signal (ALM signal)	61, 170
2)	Inverter running status	Operation ready signal check	Operation ready signal (RY signal)	61, 169
3)	Inverter running status	Logic check of the start signal and running signal	Start signal (STF signal, STR signal) Running signal (RUN signal)	60, 61, 169
4)	Inverter running status	Logic check of the start signal and output current	Start signal (STF signal, STR signal) Output current detection signal (Y12 signal)	60, 61, 172

1) Check by the output of the inverter fault signal

When the inverter's protective function activates and the inverter trips, the fault output signal (ALM signal) is output.

With this signal, you can check if the inverter is operating properly.

In addition, negative logic can be set (ON when the inverter is normal, OFF when a fault occurs).

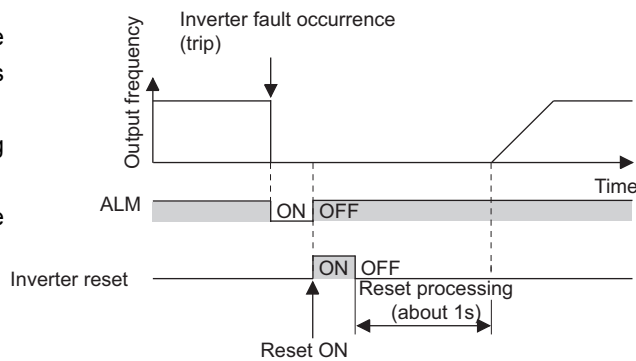

2) Checking the inverter operating status by the inverter operation ready completion signal

Operation ready signal (RY signal) is output when the inverter power is on and the inverter becomes operative. Check if the RY signal is output after powering ON the inverter.

3) Checking the inverter operating status by the start signal input to the inverter and inverter running signal.

The inverter running signal (RUN signal) is output when the inverter is running.

Check if RUN signal is output when inputting the start signal to the inverter (forward signal is STF signal and reverse signal is STR signal). For logic check, note that RUN signal is output for the period from the inverter decelerates until output to the motor is stopped, configure a sequence considering the inverter deceleration time

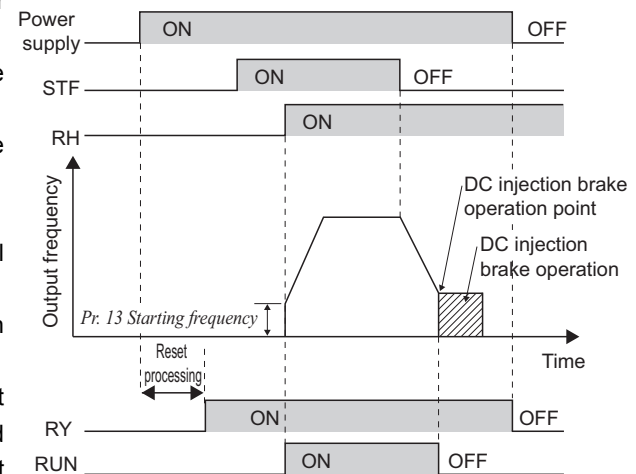

REMARKS

- RUN signal is assigned to the terminal Y0 in the initial status. In the initial setting, the operating status of the inverter can be checked with the lamp, etc., which is connected to the terminal Y0, or a virtual terminal of CC-Link communication.

4) Checking the motor operating status by the start signal input to the inverter and inverter output current detection signal.

The output current detection signal (Y12 signal) is output when the inverter operates and currents flows in the motor. Check if Y12 signal is output when inputting the start signal to the inverter (forward signal is STF signal and reverse signal is STR signal). Note that the current level at which Y12 signal is output is set to 150% of the inverter rated current in the initial setting, it is necessary to adjust the level to around 20% using no load current of the motor as reference with *Pr.150 Output current detection level*.

For logic check, as same as the inverter running signal (RUN signal), the inverter outputs for the period from the inverter decelerates until output to the motor is stopped, configure a sequence considering the inverter deceleration time.

Output signal	Pr. 190 to Pr. 192, Pr. 313 to Pr. 315	
	Setting	
	Positive logic	Negative logic
ALM	99	199
RY	11	111
RUN	0	100
Y12	12	112

- When using various signals, assign functions to *Pr. 190 to Pr. 192, Pr. 313 to Pr. 315 (output terminal function selection)* referring to the table on the left.



NOTE

- Changing the assignment of the terminal Y0 or a virtual terminal of CC-Link communication with one of *Pr.190 to Pr.192, and Pr.313 to Pr.315 (output terminal function selection)* may affect other functions. Set parameters after confirming the functions of the terminal Y0 and virtual terminals.

(2) Backup method outside the inverter

Even if the interlock is provided by the inverter status signal, enough failsafe is not ensured depending on the failure status of the inverter itself. For example, when the inverter CPU fails, even if the interlock is provided using the inverter fault output signal, start signal and RUN signal output, there is a case where a fault output signal is not output and RUN signal is kept output even if an inverter fault occurs.

Provide a speed detector to detect the motor speed and current detector to detect the motor current and consider the backup system such as checking up as below according to the level of importance of the system.

1) Start signal and actual operation check

Check the motor running and motor current while the start signal is input to the inverter by comparing the start signal to the inverter and detected speed of the speed detector or detected current of the current detector. Note that the motor current runs as the motor is running for the period until the motor stops since the inverter starts decelerating even if the start signal turns off. For the logic check, configure a sequence considering the inverter deceleration time. In addition, it is recommended to check the three-phase current when using the current detector.

2) Command speed and actual operation check

Check if there is no gap between the actual speed and commanded speed by comparing the inverter speed command and detected speed of the speed detector.

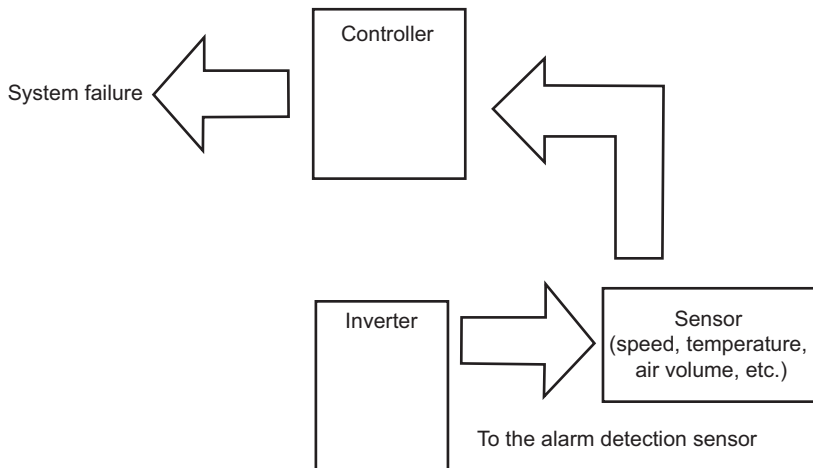

MEMO

4 **CC-LINK COMMUNICATION FUNCTION**

This chapter explains the "CC-Link communication function" for use of this product.

Always read the instructions before using the equipment.

4.1	CC-Link communication specifications.....	48
4.2	CC-Link version	48
4.3	Wiring for CC-Link communication.....	49
4.4	Function overview	54
4.5	I/O signal list.....	56
4.6	Details of I/O signals.....	60
4.7	Programming examples	67
4.8	How to check for error using the LEDs	75

1

2

3

4

5

6

7

8

4.1 CC-Link communication specifications

Type	Built-in to the inverter, one-touch connector connection, online connector (T type (2 to 1)) supported
Power supply	Supplied from the inverter or the external 24VDC power supply
Number of units connected	42 units max. (Refer to page 106 for the number of stations occupied.) May be used with other equipment.
Station type	Remote device station
Number of stations occupied	CC-Link Ver. 1: occupies one station CC-Link Ver. 2: occupies one station (selectable among double, quadruple and octuple)
Communication cable	CC-Link dedicated cable, CC-Link Ver. 1.10 compatible CC-Link dedicated cable

4.2 CC-Link version

4.2.1 CC-Link Ver. 1.10

The conventional CC-Link products, whose inter-station cable lengths have equally been changed to 20cm or more to improve the inter-station cable length restriction, are defined as CC-Link Ver. 1.10. In comparison, the conventional products are defined as CC-Link Ver. 1.00.

Refer to the CC-Link Master Module Manual for the maximum overall cable lengths and inter-station cable lengths of CC-Link Ver. 1.00 and Ver. 1.10.

CC-Link Ver. 1.10 compatibility conditions
1) All modules that comprise a CC-Link system should be compatible with CC-Link Ver. 1.10.
2) All data link cables should be CC-Link Ver. 1.10 compatible, CC-Link dedicated cables. (CC-Link Ver. 1.10 compatible cables have a  logo or Ver. 1.10 indication.)



CAUTION

- In a system that uses the CC-Link Ver. 1.00 and Ver. 1.10 modules and cables together, the maximum overall cable length and inter-station cable length are as specified for CC-Link Ver. 1.00.

4.2.2 CC-Link Ver. 2

The FR-E700-NC is compatible with CC-Link Ver. 2.

When using the CC-Link Ver. 2 setting with the FR-E700-NC, the master station needs to be compatible with the CC-Link Ver. 2. For CC-Link Ver. 2, double, quadruple and octuple settings can be used to increase the remote register (RWr/w) points.

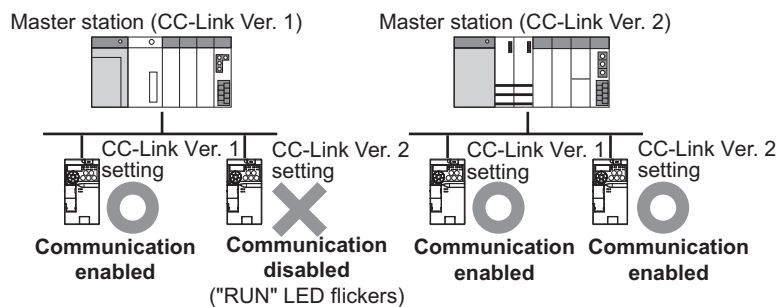

4.3 Wiring for CC-Link communication

4.3.1 System configuration example

(1) Programmable controller side

Mount the "QJ61BT11N", "LJ61BT11", "AJ61QBT11", "A1SJ61QBT11", "AJ61BT11" or "A1SJ61BT11" "CC-Link system master/local module" on the main or extension base unit having the programmable controller CPU used as the master station.

(2) Connect the master station of the CC-Link programmable controller unit to the CC-Link communication connector of FR-E700-NC with the CC-Link dedicated cable.

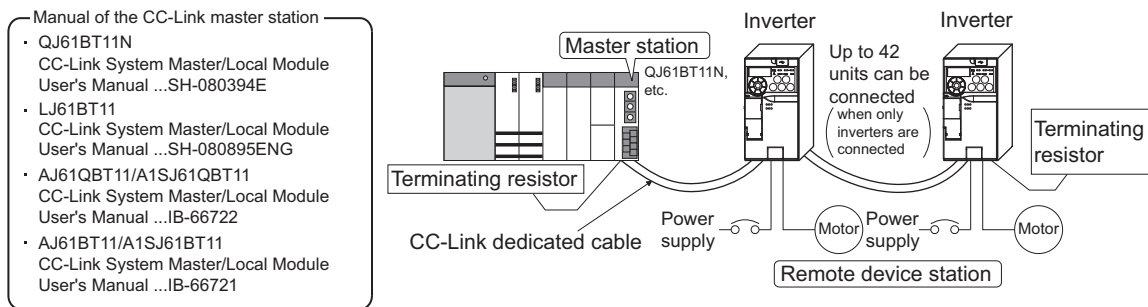

REMARKS

- When the CPU has the automatic refresh function (example: QnA series CPU)
Through communication with the corresponding devices using sequence ladder logic, data is automatically transferred to the refresh buffer of the master station at the execution of the END instruction to perform communication with the remote devices.
- When the CPU does not have the automatic refresh function (example: AnA series CPU)
Data is transferred to the refresh buffer of the master station directly by sequence ladder logic to perform communication with the remote devices.

4.3.2 Connection of several inverters

An inverter can join the link system as a CC-Link remote device station, and such device stations can be controlled and monitored with a user program of a programmable controller. These devices can be useful components of an automated factory. Connect shielding wires of the CC-Link dedicated cable to "SLD" of each unit.

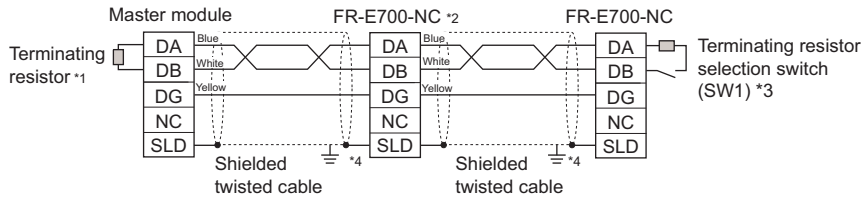

*1 Use the terminating resistors supplied with the programmable controller.

*2 Set "1" and "2" of the terminating resistor selection switch (SW1) to OFF (without terminating resistor) in the middle units.

	1	2	Description
	OFF	OFF	Without terminating resistor (initial setting)
	ON	OFF	Do not use.
	OFF	ON	130Ω
	ON	ON	110Ω

130Ω is a resistance value for the CC-Link Ver. 1.00 dedicated high performance cable

*3 Set the terminating resistor selection switch (SW1). Refer to page 2 for switch positions.)

Do not use the built-in terminating resistor selection switch (SW1) when using a one-touch connector plug with terminating resistor. (SW1-OFF, 2-OFF) (Refer to page 53 for the details of the one-touch connector plug with terminating resistor.)

*4 Use a conduction area of a P-clip (enclosed item) to ground (earth) shielding wires of the CC-Link dedicated cable to a position (as close as possible to the inverter) on the enclosure. Take caution not to subject the CC-Link communication connector to stress. (Refer to page 52)

(1) Maximum number of units connected to one master station (CC-Link Ver. 1.10) 42 units (when only inverters are connected)

If any other units are included, the number of stations occupied depends on the unit and therefore the following conditions must be satisfied:

$$\{(1 \times a) + (2 \times b) + (3 \times c) + (4 \times d)\} \leq 64$$

a: Number of units occupying 1 station c: Number of units occupying 3 stations
b: Number of units occupying 2 stations d: Number of units occupying 4 stations

$$\{(16 \times A) + (54 \times B) + (88 \times C)\} \leq 2304$$

A: Number of remote I/O ≤ 64
B: Number of remote device stations ≤ 42
C: Number of local, standby master and intelligent device stations ≤ 26

(2) Maximum number of units connected to one master station (CC-Link Ver. 2.00) 42 units (when only inverters are connected)

If any other units are included, the number of stations occupied depends on the unit and therefore the following conditions must be satisfied:

$$\bullet \{(a + a2 + a4 + a8) + (b + b2 + b4 + b8) \times 2 + (c + c2 + c4 + c8) \times 3 + (d + d2 + d4 + d8) \times 4\} \leq 64$$

$$\bullet \{(a \times 32 + a2 \times 32 + a4 \times 64 + a8 \times 128) + (b \times 64 + b2 \times 96 + b4 \times 192 + b8 \times 384) + (c \times 96 + c2 \times 160 + c4 \times 320 + c8 \times 640) + (d \times 128 + d2 \times 224 + d4 \times 448 + d8 \times 896)\} \leq 8192$$

$$\bullet \{(a \times 4 + a2 \times 8 + a4 \times 16 + a8 \times 32) + (b \times 8 + b2 \times 16 + b4 \times 32 + b8 \times 64) + (c \times 12 + c2 \times 24 + c4 \times 48 + c8 \times 96) + (d \times 16 + d2 \times 32 + d4 \times 64 + d8 \times 128)\} \leq 2048$$

a: Number of single setting devices occupying one station
b: Number of single setting devices occupying two stations
c: Number of single setting devices occupying three stations
d: Number of single setting devices occupying four stations
a2: Number of double setting devices occupying one station
b2: Number of double setting devices occupying two stations
c2: Number of double setting devices occupying three stations
d2: Number of double setting devices occupying four stations
a4: Number of quadruple setting devices occupying one station
b4: Number of quadruple setting devices occupying two stations
c4: Number of quadruple setting devices occupying three stations
d4: Number of quadruple setting devices occupying four stations
a8: Number of octuple setting devices occupying one station
b8: Number of octuple setting devices occupying two stations
c8: Number of octuple setting devices occupying three stations
d8: Number of octuple setting devices occupying four stations

$$\bullet 16 \times A + 54 \times B + 88 \times C \leq 2304$$

A: Numbers of remote I/O ≤ 64
B: Number of remote device stations ≤ 42
C: Number of local and intelligent device stations ≤ 26

4.3.3 Connection cable and plug

In the CC-Link system, use CC-Link dedicated cables.

If the cable used is other than the CC-Link dedicated cable, the performance of the CC-Link system is not guaranteed.

For the specifications of the CC-Link dedicated cable, refer to the website of the CC-Link Partner Association.

- Website of the CC-Link Partner Association <http://www.cc-link.org/>
- One-touch communication connector plug (as of December 2009)

Refer to the following table for the plug required to fabricate a cable on your own.

Model	Manufacturer
A6CON-L5P	Mitsubishi Electric Corporation
35505-6000-B0M GF	Sumitomo 3M Limited

(1) Cable-end treatment

Apply the following treatment to the CC-Link dedicated cable that is inserted to a one-touch communication connector plug.

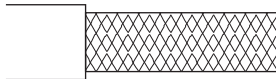
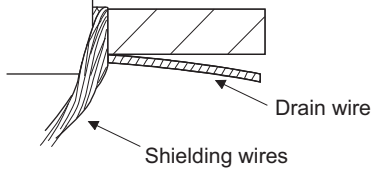
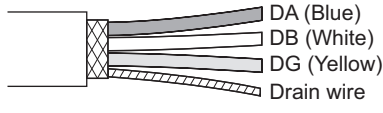
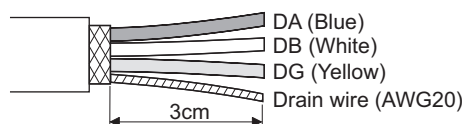
<p>1. Cut the sheath</p> 	<p>2. Separate shielding wires from the drain wire. Cut the shielding wires.</p> 
<p>3. Cut the aluminum tape and braid.</p> 	<p>4. Straighten the drain wire and twist it from the root. (Twist seven times or more per 3cm.)</p> 

REMARKS

- Where possible, round the cable tip that is cut off with a tool such as nippers. If the cable is not rounded, it may get caught in the middle of a plug, without fully entering into the plug.
- If required, apply an insulation treatment to the shielding wire area where it is not covered by the one-touch communication connector plug.

(2) Plug cover check

Check that a plug cover is snapped into a plug

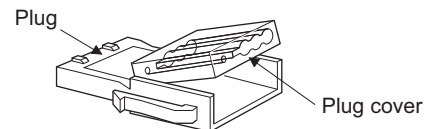

Note

- Do not push the plug cover onto the plug before inserting a cable. Once crimped, the plug cover cannot be reused.

(3) Cable insertion

Lift up the tail of the plug cover, and fully insert a cable. Insert different signal wires to the one-touch communication connector plug as shown in the right figure.

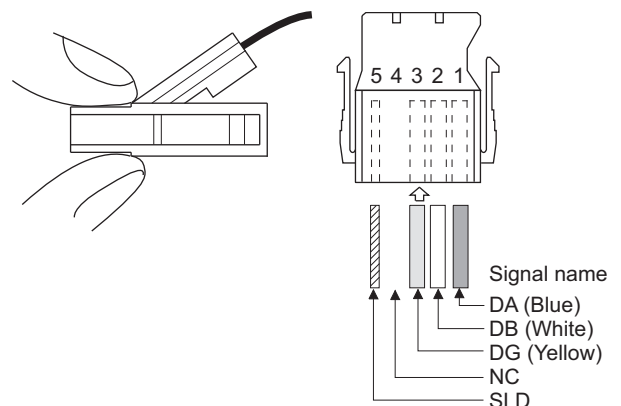

REMARKS

- Insert the cable fully. Failure to do so may cause a crimping failure.
- A cable sometimes comes out of the head of the cover. In that case, pull the cable a little so that the cable stays under the plug cover.

(4) Crimping the plug cover

Push the plug cover onto the plug with a tool such as pliers. After crimping, check that the plug cover is securely snapped into the plug as shown in the right figure.

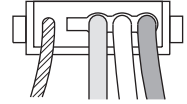

REMARKS

- Misaligned latches between the plug cover and the plug may keep the cover lifted. The plug cover is not sufficiently crimped in this condition. Push the plug cover until it snaps into the plug.

4.3.4 Connection of CC-Link dedicated cable

(1) Connection to the connector

Connect the CC-Link dedicated cable to the CC-link communication connector

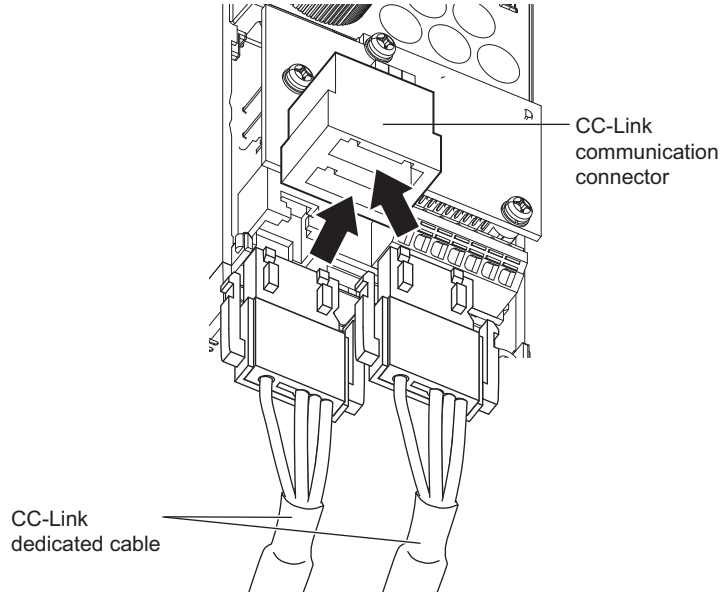

(2) Grounding (earthing) the CC-Link dedicated cable

Use an M4 screw and a conduction area of a P-clip (enclosed item) to ground (earth) shielding wires of the CC-Link dedicated cable to a position (as close as possible to the inverter) on the enclosure.

Take caution not to subject the CC-Link communication connector to stress.

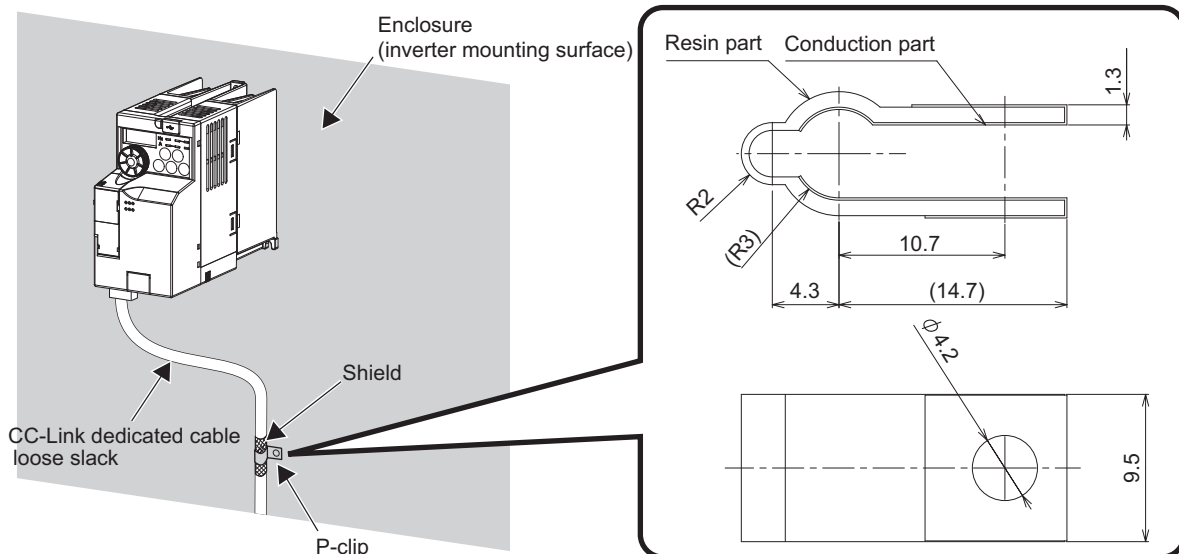

CAUTION

- Take caution not to subject the cables to stress.
- After wiring, wire offcuts must not be left in the inverter. Wire offcuts can cause an alarm, failure or malfunction.

4.3.5 Unit replacement while online

Connect an online communication connector to the CC-Link communication connector. The online communication connector enables a unit replacement without interrupting the communication. Always connect the online communication connector to CONA (front side) of the CC-Link communication connector. (Do not connect it to CONB (back side) of the CC-Link communication connector. Doing so will cause a failure or breakage of the inverter and the connectors.)

Also connect a one-touch connector plug with terminating resistor to the CC-Link communication connector of FR-E700-NC at the end.

(A replacement while online is not available for the units, which are using the built-in terminating resistor selection switches (SW1).)

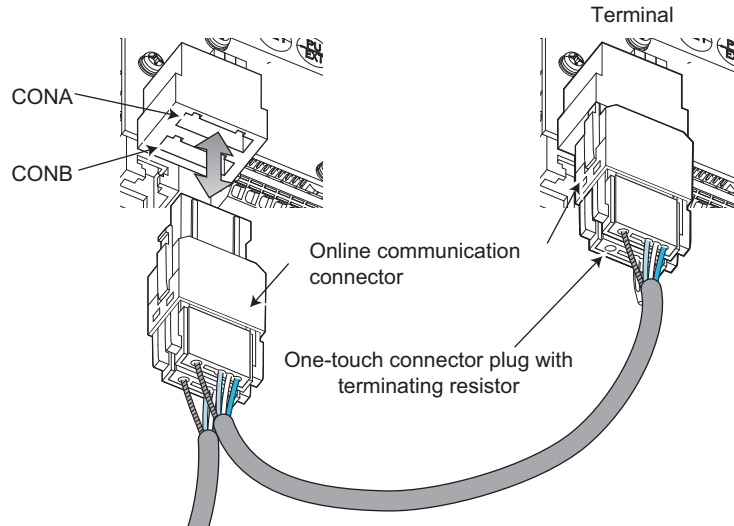

Use the following online communication connector and one-touch connector plug with terminating resistor.

- Online communication connector (as of December 2009)

Model	Manufacturer
35715-L010-B00 AK	Sumitomo 3M Limited

- One-touch connector plug with terminating resistor (as of December 2009)

Model	Manufacturer
A6CON-TR11	Mitsubishi Electric Corporation



Note

- Do not use the online communication connector A6CON-LJ5P (Mitsubishi Electric Corporation) and 35720-L200-B00 AK (Sumitomo 3M Limited) for this product. Doing so will cause a failure or breakage of the inverter and the connectors.

4.4 Function overview

4.4.1 Function block diagram

Using function blocks, this section explains I/O data transfer to/from an inverter in CC-Link:

- Link refresh is continuously executed between the master station and inverter in the CC-Link system at intervals of 1.1ms to 141ms (per station).

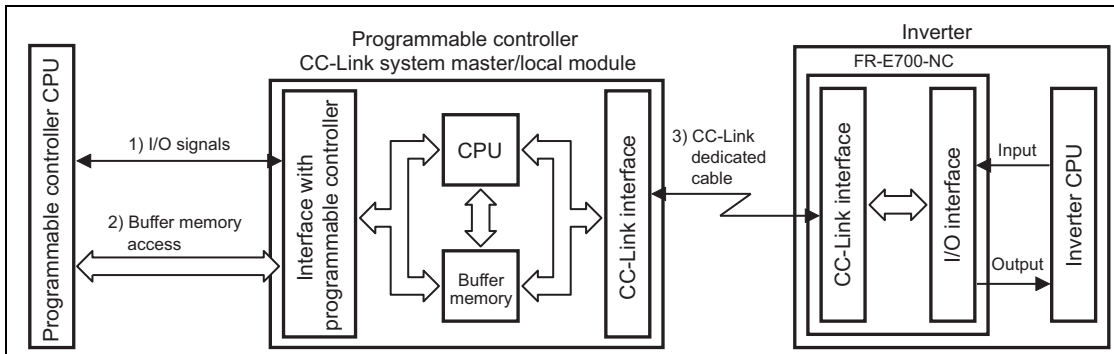

1) These are I/O signals assigned to the CC-Link system master/local module. These signals are used for communication between the programmable controller CPU and CC-Link system master/local module.

Refer to page 60 for details of the signals.

2) Reading of data input to the inverter, writing of inverter output data, and reading of a faulty CC-Link station are available. Automatic refresh function enables reading from/writing to buffer memory. (Use FROM/TO command of the sequence program to synchronize without using the automatic refresh function.) Refer to CC-Link system master/local module manual for the buffer memory details.

3) CC-Link communication start command is given from the sequence program. After the CC-Link communication starts, link refresh is always performed asynchronously (or synchronously) with execution of sequence program. For details, refer to the CC-Link system master/local module manual.

4.4.2 Output from the inverter to the network

Main items which can be output from the inverter to the master and their descriptions are explained below.

Item	Description	Refer to Page
Inverter status monitor	The output terminal status of the inverter can be monitored.	61
Output frequency monitor	The output frequency can be monitored.	63, 64
Output current monitor	The output current can be monitored.	64
Output voltage monitor	The output voltage can be monitored.	64
Special monitor	The monitor data selected can be checked.	64
Faults history	Fault records can be checked.	63, 64
Data at alarm occurrence	The inverter status at alarm occurrence can be checked.	63
Operation mode	The current operation mode can be checked.	64
Parameter read	Parameter settings can be read.	64
Read of set frequency	The current set frequency can be read.	64



REMARKS

- Refer to page 104 for the operable functions via network in each operation mode.

4.4.3 Input to the inverter from the network

Main items which can be commanded from the master to the inverter and their descriptions are explained below.

Item	Description	Refer to Page
Forward rotation command	Gives the forward rotation command.	60
Reverse rotation command	Gives the reverse rotation command.	60
Input terminal function command	Executes functions assigned to the inverter input terminals.	60
Inverter output stop command	Stops the inverter output.	60
Error reset	Resets the inverter only when an inverter alarm occurs.	60
Frequency setting	Sets the frequency.	62, 64
Monitor command	Specifies the description monitored.	62, 64
Operation mode specification	Sets the operation mode.	64
Faults history clear	Erases past eight fault records.	64
All parameter clear	Returns the parameter descriptions to the initial value.	64
Inverter reset	Resets the inverter.	64
Parameter write	Writes parameter settings.	64
PID control	PID set point, PID measured value and PID deviation can be input from the network.	62



REMARKS

- Refer to page 104 for the operable functions via network in each operation mode.

4.5 I/O signal list

4.5.1 I/O signals when CC-Link Ver. 1 one station (FR-E500 series compatible) is occupied (Pr. 544 = "0")

(1) Remote I/O (32 points fixed)

Device No.	Signal	Refer to Page	Device No.	Signal	Refer to Page
RYn0	Forward rotation command (STF signal) *2	60	RXn0	Forward running	61
RYn1	Reverse rotation command (STR signal) *2	60	RXn1	Reverse running	61
RYn2	High-speed operation command (RH signal) *1	60	RXn2	Running (terminal Y0 function) *3	61
RYn3	Middle-speed operation command (RM signal) *1	60	RXn3	Up to frequency (SU signal) *2	61
RYn4	Low-speed operation command (RL signal) *1	60	RXn4	Overload alarm (OL signal) *2	61
RYn5	Not used	—	RXn5	Not used	—
RYn6	Second function selection (RT signal) *2	60	RXn6	Frequency detection (FU signal) *3	61
RYn7	Not used	—	RXn7	Error (ALM signal) *3	61
RYn8	Not used	—	RXn8	Not used	—
RYn9	Output stop (MRS signal) *1	60	RXn9	— *4	61
RYnA	Not used	—	RXnA	— *4	61
RYnB	— *1	60	RXnB	— *4	61
RYnC	Monitor command	60	RXnC	Monitoring	61
RYnD	Frequency setting command (RAM)	60	RXnD	Frequency setting completion (RAM)	61
RYnE	Frequency setting command (RAM, EEPROM)	60	RXnE	Frequency setting completion (RAM, EEPROM)	61
RYnF	Instruction code execution request	60	RXnF	Instruction code execution completion	61
RY(n+1)0 to RY(n+1)7	Reserved	—	RX(n+1)0 to RX(n+1)7	Reserved	—
RY(n+1)8	Not used (initial data process completion flag)	—	RX(n+1)8	Not used (initial data process request flag)	—
RY(n+1)9	Not used (initial data process request flag)	—	RX(n+1)9	Not used (initial data process completion flag)	—
RY(n+1)A	Error reset request flag	60	RX(n+1)A	Error status flag	61
RY(n+1)0 to RY(n+1)F	Reserved	—	RX(n+1)B	Remote station ready	61
			RX(n+1)0 to RX(n+1)F	Reserved	—

("n" indicates a value determined according to the station number setting.)

*1 These signals are set in the initial status. Using Pr. 180 to Pr. 184, you can change input signal functions.

Refer to page 163 for details of Pr. 180 to Pr. 184.

*2 The signal is not changeable.

*3 These signals are set in the initial status. Using Pr. 190 to Pr. 192, you can change output signal functions.

Refer to page 167 for signals which can be assigned.

*4 No signal is assigned in the initial setting. Output signal can be assigned using Pr. 313 to Pr. 315.

Refer to page 167 for signals which can be assigned.

(2) Remote register

Address	Description		Refer to Page	Address	Description	Refer to Page
	Upper 8 Bits	Lower 8 Bits				
RWwn	Monitor code 2	Monitor code 1	62	RWrn	First monitor value	63
RWwn+1	Set frequency (0.01Hz increments) *2		62	RWrn+1	Second monitor value	63
RWwn+2	H00 (arbitrary) *1	Instruction code	62	RWrn+2	Reply code	63
RWwn+3	Write data		62	RWrn+3	Read data	63

("n" indicates a value determined according to the station number setting.)

*1 The above 8 bit is always H00 even if a value other than H00 is set.

*2 When Pr. 37 is not equal to "0", this will be machine speed display (1 increments).



Parameters referred to

- Pr. 37 Speed display Refer to page 175
- Pr. 180 to Pr.184 (input terminal function selection) Refer to page 163
- Pr. 190 to Pr. 192, Pr. 313 to Pr.315 (output terminal function selection) Refer to page 167
- Pr. 544 CC-Link extended setting Refer to page 105

4.5.2 I/O signals when CC-Link Ver. 1 one station is occupied (Pr. 544 = "1")**(1) Remote I/O (32 points)**

Same as when Pr. 544 = "0" (Refer to page 56)



(2) Remote register

Address	Description		Refer to Page	Address	Description		Refer to Page
	Upper 8 Bits	Lower 8 Bits			Upper 8 Bits	Lower 8 Bits	
RWwn	Monitor code 2	Monitor code 1	62	RWrn	First monitor value		63
RWwn+1	Set frequency (0.01Hz increments) *1		62	RWrn+1	Second monitor value		63
RWwn+2	Link parameter extended setting	Instruction code	62	RWrn+2	Reply code 2	Reply code 1	63
RWwn+3	Write data		62	RWrn+3	Read data		63

("n" indicates a value determined according to the station number setting.)

*1 When Pr. 37 is not equal to "0", this will be machine speed display (1 increments).

**Parameters referred to**

- Pr. 37 Speed display  Refer to page 175
- Pr. 544 CC-Link extended setting  Refer to page 105

4.5.3 I/O signals when CC-Link Ver. 2 double setting is selected (Pr. 544 = "12")**(1) Remote I/O (32 points)**

Same as when Pr. 544 = "0" (Refer to page 56)



(2) Remote register

Address	Description		Refer to Page	Address	Description		Refer to Page
	Upper 8 Bits	Lower 8 Bits			Upper 8 Bits	Lower 8 Bits	
RWwn	Monitor code 2	Monitor code 1	62	RWrn	First monitor value		63
RWwn+1	Set frequency (0.01Hz increments) *1		62	RWrn+1	Second monitor value		63
RWwn+2	Link parameter extended setting	Instruction code	62	RWrn+2	Reply code 2	Reply code 1	63
RWwn+3	Write data		62	RWrn+3	Read data		63
RWwn+4	Monitor code 3		62	RWrn+4	Third monitor value		63
RWwn+5	Monitor code 4		62	RWrn+5	Fourth monitor value		63
RWwn+6	Monitor code 5		62	RWrn+6	Fifth monitor value		63
RWwn+7	Monitor code 6		62	RWrn+7	Sixth monitor value		63

("n" indicates a value determined according to the station number setting.)

*1 When Pr. 37 is not equal to "0", this will be machine speed display (1 increments).

**Parameters referred to**

- Pr. 37 Speed display  Refer to page 175
- Pr. 544 CC-Link extended setting  Refer to page 105

4.5.4 I/O signals when CC-Link Ver. 2 quadruple setting is selected (Pr. 544 = "14")

(1) Remote I/O (32 points)

Same as when Pr. 544 = "0" (Refer to page 56)

(2) Remote register

Address	Description		Refer to Page	Address	Description		Refer to Page
	Upper 8 Bits	Lower 8 Bits			Upper 8 Bits	Lower 8 Bits	
RWwn	Monitor code 2	Monitor code 1	62	RWrn	First monitor value		63
RWwn+1	Set frequency (0.01Hz increments)*2		62	RWrn+1	Second monitor value		63
RWwn+2	Link parameter extended setting	Instruction code	62	RWrn+2	Reply code 2	Reply code 1	63
RWwn+3	Write data		62	RWrn+3	Read data		63
RWwn+4	Monitor code 3		62	RWrn+4	Third monitor value		63
RWwn+5	Monitor code 4		62	RWrn+5	Fourth monitor value		63
RWwn+6	Monitor code 5		62	RWrn+6	Fifth monitor value		63
RWwn+7	Monitor code 6		62	RWrn+7	Sixth monitor value		63
RWwn+8	Faults history No.	H00	62	RWrn+8	Faults history No.	Fault data	63
RWwn+9	PID set point (0.01% increments) *1		62	RWrn+9	Fault record (output frequency)		63
RWwn+A	PID measured value (0.01% increments) *1		62	RWrn+A	Fault record (output current)		63
RWwn+B	PID deviation (0.01% increments) *1		62	RWrn+B	Fault record (output voltage)		63
RWwn+C	H00 (Free)		—	RWrn+C	Fault record (energization time)		63
RWwn+D				H00 (Free)		—	
RWwn+E							
RWwn+F							

("n" indicates a value determined according to the station number setting.)

*1 When Pr. 128 = "50, 51, 60, 61", they are valid.

*2 When Pr. 37 is not equal to "0", this will be machine speed display (1 increments).



Parameters referred to

- Pr. 37 Speed display Refer to page 175
- Pr. 128 PID action selection Refer to page 203
- Pr. 544 CC-Link extended setting Refer to page 105

4.5.5 I/O signals when CC-Link Ver. 2 octuple setting is selected (Pr. 544 = "18")

(1) Remote I/O (32 points)

Same as when Pr. 544 = "0" (Refer to page 56)

(2) Remote register

Address	Description		Refer to Page	Address	Description		Refer to Page
	Upper 8 Bits	Lower 8 Bits			Upper 8 Bits	Lower 8 Bits	
RWwn	Monitor code 2	Monitor code 1	62	RWrn	First monitor value		63
RWwn+1	Set frequency (0.01Hz increments) *2		62	RWrn+1	Second monitor value		63
RWwn+2	Link parameter extended setting	Instruction code	62	RWrn+2	Reply code 2	Reply code 1	63
RWwn+3	Write data		62	RWrn+3	Read data		63
RWwn+4	Monitor code 3		62	RWrn+4	Third monitor value		63
RWwn+5	Monitor code 4		62	RWrn+5	Fourth monitor value		63
RWwn+6	Monitor code 5		62	RWrn+6	Fifth monitor value		63
RWwn+7	Monitor code 6		62	RWrn+7	Sixth monitor value		63
RWwn+8	Faults history No.	H00	62	RWrn+8	Faults history No.	Fault data	63
RWwn+9	PID set point (0.01% increments) *1		62	RWrn+9	Fault record (output frequency)		63
RWwn+A	PID measured value (0.01% increments) *1		62	RWrn+A	Fault record (output current)		63
RWwn+B	PID deviation (0.01% increments) *1		62	RWrn+B	Fault record (output voltage)		63
RWwn+C	H00 (Free)		—	RWrn+C	Fault record (energization time)		63
RWwn+D				H00 (Free)	—		
RWwn+E							
RWwn+F							
RWwn+10						Link parameter extended setting	Instruction code
RWwn+11	Write data		62	RWrn+11	Read data		63
RWwn+12	Link parameter extended setting	Instruction code	62	RWrn+12	Reply code		63
RWwn+13	Write data		62	RWrn+13	Read data		63
RWwn+14	Link parameter extended setting	Instruction code	62	RWrn+14	Reply code		63
RWwn+15	Write data		62	RWrn+15	Read data		63
RWwn+16	Link parameter extended setting	Instruction code	62	RWrn+16	Reply code		63
RWwn+17	Write data		62	RWrn+17	Read data		63
RWwn+18	Link parameter extended setting	Instruction code	62	RWrn+18	Reply code		63
RWwn+19	Write data		62	RWrn+19	Read data		63
RWwn+1A	H00 (Free)		—	RWrn+1A	H00 (Free)		—
RWwn+1B							
RWwn+1C							
RWwn+1D							
RWwn+1E							
RWwn+1F							



("n" indicates a value determined according to the station number setting.)

*1 When Pr. 128 = "50, 51, 60, 61", they are valid.

*2 When Pr. 37 is not equal to "0", this will be machine speed display (1 increments).



Parameters referred to

- Pr. 37 Speed display  Refer to page 175
- Pr. 128 PID action selection  Refer to page 203
- Pr. 544 CC-Link extended setting  Refer to page 105

4.6 Details of I/O signals

The following device numbers are for the station 1.

For the stations 2 and later, the device numbers are different. (Refer to *the master module manual* for the correspondence between device numbers and station numbers.)

4.6.1 Details of remote I/O signals

(1) Output signals (master module to inverter)

The output signals from the master module are indicated. (Input signals to the inverter)

Device No.	Signal	Description	
RY0	Forward rotation command (STF signal) *2	OFF: Stop command ON: Forward rotation start	When "1" is set, a start command is input to the inverter. When "1" is set in RY0 and RY1, a stop command is input.
RY1	Reverse rotation command (STR signal) *2	OFF: Stop command ON: Reverse rotation start	(Refer to <i>page 165</i> for the details of the STF and STR signals.)
RY2	High-speed operation command (RH signal) *1	Turning ON the signal activates the function assigned to <i>Pr. 182</i> .	
RY3	Middle-speed operation command (RM signal) *1	Turning ON the signal activates the function assigned to <i>Pr. 181</i> .	
RY4	Low-speed operation command (RL signal) *1	Turning ON the signal activates the function assigned to <i>Pr. 180</i> .	
RY6	Second function selection (RT signal) *2	ON: Second function is selected	
RY9	Output stop (MRS signal) *1	Turning ON the signal activates the function assigned to <i>Pr. 183</i> .	
RYB	— *3	Turning ON the signal activates the function assigned to <i>Pr. 184</i> .	
RYC	Monitor command	When "1" is set in the monitor command (RYC), the monitored value is set in the remote register RWr0, 1, 4 to 7, and "1" is set in the monitoring (RXC). While "1" is set in the monitor command (RYC), the monitored data is always updated.	
RYD *5	Frequency setting command (RAM)	When "1" is set in the frequency setting command (RYD), the set frequency (RWw1) is written to RAM of the inverter. *4 After the writing completes, "1" is set in the frequency setting completion (RXD).	
RYE *5	Frequency setting command (RAM, EEPROM)	When "1" is set in the frequency setting command (RYE), the set frequency (RWw1) is written to RAM and EEPROM of the inverter. After the writing completes, "1" is set in the frequency setting completion (RXE). To change the frequency consecutively, be sure to write data to the inverter RAM.	
RYF *5	Instruction code execution request	When "1" is set in the instruction code execution request (RYF), processes corresponding to the instruction codes set to RWw2, 10, 12, 14, 16 and 18 are executed. "1" is set in the instruction code execution request (RXF) after completion of instruction codes. When an instruction code execution error occurs, a value other than "0" is set in the reply code (RWr2, 10, 12, 14, 16, 18).	
RY1A	Error reset request flag	When "1" is set in the error reset request flag (RY1A) at an inverter fault, the inverter is reset, then "0" is set in the error status flag (RX1A). *6	

*1 Signal names are initial values. Using *Pr. 180 to Pr. 183*, you can change input signal functions. Refer to *page 163* for details of *Pr. 180 to Pr. 183*.

*2 The signal is not changeable.

*3 No signal is assigned in the initial setting. Using *Pr. 184*, you can change the assigned input signal. Refer to *page 163* for the details of *Pr. 184*.

*4 While "1" is set in the frequency setting command (RYD), the set frequency (RWw1) is always applied.

*5 If "1" is set in these registers at the same time while *Pr. 544* = "0," only one of these is executed.

*6 Refer to *page 110* for operation conditions of inverter reset.

(2) Input signals (inverter to master module)

The input signals to the master module are indicated. (Output signals from the inverter)

Device No.	Signal	Description
RX0	Forward running	OFF: Other than forward running (during stop or reverse rotation) ON: Forward running
RX1	Reverse running	OFF: Other than reverse running (during stop or forward rotation) ON: Reverse running
RX2	Running (terminal Y0 function) *1	Turning ON the signal activates the function assigned to Pr. 190.
RX3	Up to frequency (SU signal) *2	ON: Output frequency has reached the set frequency
RX4	Overload alarm (OL signal) *2	ON: Overload alarm occurrence
RX6	Frequency detection (FU signal) *1	Turning ON the signal activates the function assigned to Pr.191.
RX7	Fault (ALM signal) *1	Turning ON the signal activates the function assigned to Pr.192.
RX9	— *3	Turning ON the signal activates the function assigned to Pr.313.
RXA	— *3	Turning ON the signal activates the function assigned to Pr.314.
RXB	— *3	Turning ON the signal activates the function assigned to Pr.315.
RXC	Monitoring	After "1" is set in the monitor command (RYC), and the monitored value is set in the remote register Rwr0, 1, 4 to 7, "1" is set in this signal. When "0" is set in the monitor command (RYC), "0" is set in this signal.
RXD	Frequency setting completion (RAM)	After "1" is set in the frequency setting command (RYD) and the frequency setting command is written to the inverter RAM, "1" is set in this signal. When "0" is set in the frequency setting command (RYD), "0" is set in this signal.
RXE	Frequency setting completion (RAM, EEPROM)	After "1" is set in the frequency setting command (RYE) and the frequency setting command is written to the inverter RAM and EEPROM, "1" is set in this signal. When "0" is set in the frequency setting command (RYE), "0" is set in this signal.
RXF	Instruction code execution completion	After "1" is set in the instruction code execution request (RYF) and the processes corresponding to the instruction codes (RWw2, 10, 12, 14, 16 and 18) are executed, "1" is set in this signal. When "0" is set in the instruction code execution request (RYF), "0" is set in this signal.
RX1A	Error status flag	When an inverter error occurs (protective function is activated), "1" is set in this signal.
RX1B	Remote station ready	When the inverter goes into the ready status upon completion of initial setting after power-ON or hardware reset, "1" is set in this signal. When an inverter error occurs (protective function is activated), "0" is set in this signal. The signal is used as an interlock signal during the write to/read from the master module.

*1 Signal names are initial values. Using Pr. 190 to Pr. 192, you can change output signal functions. Refer to page 167 for details of Pr. 190 to Pr.192.

*2 The signal is not changeable.

*3 Signals are not assigned in the initial setting. Using Pr. 313 to Pr. 315, you can change output signal functions. Refer to Pr. 313 to Pr. 315 on page 167 for details of signals.

 **REMARKS**

- All the outputs are shutoff at an option fault (E. i).

4.6.2 Details of remote registers

(1) Remote register (master module to inverter)

• Remote register definition

Device No.	Signal	Description	
RWw0	Monitor code1/ Monitor code2	Set the monitor code to be monitored (<i>Refer to page 66</i>). By setting "1" in RYC after setting, the specified monitored data is stored in RWr0/RWr1.	
RWw1	Set frequency *1, *2	<ul style="list-style-type: none"> Specify the set frequency or machine speed. At this time, whether to write to RAM or EEPROM is decided with the RYD and RYE settings. After setting the set frequency in this register, set "1" in RYD or RYE to write the frequency. After writing of frequency is completed, "1" is set in RXD or RXE in response to the input command. The setting range is 0 to 400.00Hz (0.01Hz increments). Write "40000" when setting 400.00Hz. 	
RWw2	Link parameter extended setting/Instruction code	<p>Set the instruction code for execution of operation mode rewrite, parameter read/write, error reference, error clear, etc. (<i>Refer to page 64</i>) Set "1" in RYF to execute the corresponding instruction after completing the register setting. "1" is set in RXF after completing the execution of the instruction.</p> <p>When a value other than "0" is set in <i>Pr. 544 CC-Link extended setting</i>, upper 8 bits are link parameter extended setting.</p> <p>Example) When reading <i>Pr. 160</i>, instruction code is H0200.</p>	
RWw3	Write data	<p>Set the data specified by the RWw2 instruction code. (When required)</p> <p>Set "1" in RYF after setting RWw2 and this register.</p> <p>Set zero when the write code is not required.</p>	
RWw4	Monitor code 3	<p>Set the monitor code to be monitored. By setting "1" in RYC after setting, the specified monitored data is stored in RWr□.</p> <p>(□ indicates a register number. (RWr4 to 7))</p>	
RWw5	Monitor code 4		
RWw6	Monitor code 5		
RWw7	Monitor code 6		
RWw8	Faults history No.	<p>Set the individual fault number of the faults history that you want to read. Up to the 8th previous fault can be read.</p> <p>Last two digits: H00 (latest fault) to H07 (8th oldest fault)</p> <p>When H08 to HFF are set, fault record becomes an unfixed value.</p>	
RWw9	PID set point *3	<p>Set the PID set point</p> <p>Setting range : "0 to 100.00%"</p>	<ul style="list-style-type: none"> Input a value 100 times greater than the value to be set. For example, input "10000" when setting 100.00%. <i>Refer to page 203</i> for details of PID control.
RWwA	PID measured value *3	<p>Set the PID measured value</p> <p>Setting range : "0 to 100.00%"</p>	
RWwB	PID deviation *3	<p>Set the PID deviation.</p> <p>Setting range : "-100.00% to 100.00%"</p>	
RWw10, RWw12, RWw14, RWw16, RWw18	Link parameter extended setting/Instruction code	<p>Set the instruction code (<i>refer to page 64</i>) for execution of operation mode rewrite, parameter read/write, error reference, error clear, etc. The instructions are executed in the following order by setting "1" in RYF after completing the register setting: RWw2, 10, 12, 14, 16, then 18. After completing the execution up to RWw18, "1" is set in RXF. Set HFFFF to disable an instruction by RWw10 to 18. (RWw2 is always executed.)</p> <p>The first 8 bits are link parameter extended setting.</p> <p>Example) When reading <i>Pr. 160</i>, instruction code is H0200.</p>	
RWw11, RWw13, RWw15, RWw17, RWw19	Write data	<p>Set the data specified by the instruction code of RWw10, 12, 14, 16, and 18. (when required)</p> <p>RWw10 and 11, 12 and 13, 14 and 15, 16 and 17, and 18 and 19 correspond each other.</p> <p>Set "1" in RYF after setting the instruction codes (RWw10, 12, 14, 16, and 18) and the corresponding register.</p> <p>Set "0" when the write code is not required.</p>	

*1 When *Pr. 37* is not equal to "0", this will be machine speed display (1 increments).

*2 When *Pr. 541 Frequency command sign selection (CC-Link)* = "1", the setting value has either + or -. When the setting value is negative, the command is inversed from starting command.

Setting range: -327.68Hz to 327.67Hz (-327.68 to 327.67) 0.01Hz increments.

For details refer to *page 106*.

*3 When *Pr. 128* = "50, 51, 60, 61", they are valid. If the data outside the range is set, the previous setting is retained.

Refer to *page 203* for details of *Pr. 128*.

(2) Remote register (inverter to master module)

• Remote register definition

Device No.	Signal	Description
RWr0	First monitor value	When "1" is set in RYC, the specified monitored data is set to the lower 8 bits of the monitor code (RWw0). When Pr. 37 Speed display ≠ 0 and output frequency or set frequency monitor is set for monitor code (RWw0), machine speed setting (1 unit) is monitored.
RWr1	Second monitor value (Output frequency)	When "0" is set to the upper 8 bits of the monitor code (RWw0), the current output frequency is always set. When a value other than "0" is set to the upper 8 bits of the monitor code (RWw0) while "1" is set in RYC, the monitor data specified by the upper 8 bits of the monitor code (RWw0) is set. When Pr. 37 Speed display ≠ 0 and output frequency or set frequency monitor is set for monitor code (RWw0), machine speed setting (1 unit) is monitored.
RWr2	Reply code * (when Pr. 544 = 0)	When "1" is set in RYD or RYE, the reply code for the frequency setting command is set. When "1" is set in RYF, the reply code corresponding to the instruction code RWw2 is set. The value "0" is set for a normal reply and any digit other than "0" is set for data fault, mode error, etc.
	Reply code 1 * (when Pr. 544 ≠ 0)	Lower 8 bits of RWr2 When "1" is set in RYD or RYE, the reply code for the frequency setting command is set.
	Reply code 2 * (when Pr. 544 ≠ 0)	Upper 8 bits of RWr2 When "1" is set in RYF, the reply code corresponding to the instruction code RWw2 is set.
RWr3	Read data	For a normal reply, the reply data to the instruction specified by the instruction code is set.
RWr4	Third monitor value	When "1" is set in RYC, the monitored data specified by the monitor code (RWw□) is saved. (□ indicates a register number (RWw4 to 7))
RWr5	Fourth monitor value	
RWr6	Fifth monitor value	When Pr. 37 Speed display ≠ 0 and output frequency or set frequency monitor is set for monitor code (RWw0), machine speed setting (1 unit) is monitored.
RWr7	Sixth monitor value	
RWr8	Fault record (fault data)	The fault data of faults history No. specified by RWw8 is stored in the lower 8 bits. Faults history No. specified is echo backed to the upper 8 bits.
RWr9	Fault record (output frequency)	Output frequency of the faults history No. specified in RWw8 is stored.
RWrA	Fault record (output current)	Output current of the faults history No. specified in RWw8 is stored.
RWrB	Fault record (output voltage)	Output voltage of the faults history No. specified in RWw8 is stored.
RWrC	Fault record (energization time)	Energization time of the faults history No. specified in RWw8 is stored.
RWr10 to RWr19	Reply code *	When "1" is set in RYF, the reply codes corresponding to the instruction codes RWw10, 12, 14, 16, and 18 are set. The value "0" is set for a normal reply and other than "0" is set for data fault, mode error, etc.
	Read data	For a normal reply, the reply data to the instruction specified by the instruction code is set.

* Refer to the table below for the reply code definitions.

• Reply code definition

The reply to the instruction execution is set to RWr2, 10, 12, 14, 16, 18.

When executing the frequency setting (RYD, RYE) or instruction code execution (RYF), check the reply code (RWr2) in the remote register after execution.

	Data	Item	Alarm Definition	Remarks
Reply code	H0000	Normal	No error (normal completion of instruction code execution)	· Reply code to Rwr2 when Pr. 544 = "0" · Reply code to RWr10, 12, 14, 16, and 18 when Pr. 544 = "18"
	H0001	Write mode error	Parameter write was attempted during operation other than a stop in the Network operation mode.	
	H0002	Parameter selection error	Unregistered code number was set.	
	H0003	Setting range error	Set data is outside the permissible data range.	
Reply code 1	H00	Normal	No error (normal completion of instruction code execution)	Reply code to RWw2 when Pr. 544 ≠ "0"
	H01	Write mode error	Parameter write was attempted during operation other than a stop in the Network operation mode.	
	H03	Frequency command setting range error	Frequency outside the range is set	
Reply code 2	H00	Normal	No error (normal completion of instruction code execution)	Reply code to RWw2 when Pr. 544 ≠ "0"
	H01	Write mode error	Parameter write was attempted during operation other than a stop in the Network operation mode.	
	H02	Parameter selection error	Unregistered code number was set.	
	H03	Setting range error	Set data is outside the permissible data range.	

(3) Instruction codes

• Instruction code definition

Set the instruction code using a remote register (RWw). (Refer to page 62.)
 The definition read by the instruction code is stored in the remote register (RWr). (Refer to page 63.)

Item		Read / Write	Code Number	Description														
Operation mode		Read	H7B	H0000: Network operation H0002: PU operation														
		Write	HFB	H0000: Network operation H0002: PU operation (When Pr. 79 = "6")														
Monitor	Output frequency *1	Read	H6F	H0000 to HFFFF: Running frequency..... 0.01Hz increments Machine speed 1 increments (When Pr. 37 ≠ "0")														
	Output current	Read	H70	H0000 to HFFFF: Output current (hexadecimal) Increments 0.01A														
	Output voltage	Read	H71	H0000 to HFFFF: Output voltage (hexadecimal) Increments 0.1V														
	Special monitor	Read	H72	H0000 to HFFFF: Check the data of the monitor selected by the instruction code HF3.														
	Special monitor selection No.	Read	H73	H01 to H3F: Monitor selection data Refer to monitor code. (Refer to page 66.)														
		Write	HF3 *2															
Faults history	Read	H74 to H77	H0000 to HFFFF: Last two fault definitions <table border="1" style="width: 100%; border-collapse: collapse;"> <tr> <td style="width: 25%; text-align: center;">b15</td> <td style="width: 50%; text-align: center;">b8 b7</td> <td style="width: 25%; text-align: center;">b0</td> </tr> <tr> <td>H74</td> <td>Second most recent fault in past</td> <td>Most recent fault</td> </tr> <tr> <td>H75</td> <td>Fourth most recent fault in past</td> <td>Third most recent fault in past</td> </tr> <tr> <td>H76</td> <td>Sixth most recent fault in past</td> <td>Fifth most recent fault in past</td> </tr> <tr> <td>H77</td> <td>Eighth most recent fault in past</td> <td>Seventh most recent fault in past</td> </tr> </table> Refer to the alarm data table (page 65)	b15	b8 b7	b0	H74	Second most recent fault in past	Most recent fault	H75	Fourth most recent fault in past	Third most recent fault in past	H76	Sixth most recent fault in past	Fifth most recent fault in past	H77	Eighth most recent fault in past	Seventh most recent fault in past
b15	b8 b7	b0																
H74	Second most recent fault in past	Most recent fault																
H75	Fourth most recent fault in past	Third most recent fault in past																
H76	Sixth most recent fault in past	Fifth most recent fault in past																
H77	Eighth most recent fault in past	Seventh most recent fault in past																
Set frequency (RAM)	Read	H6D	Read set frequency or machine speed from RAM or EEPROM. · H0000 to HFFFF:															
Set frequency (EEPROM)	Read	H6E	Set frequency 0.01Hz increments Machine speed 1 increments (When Pr. 37 ≠ "0")															
Set frequency (RAM) *3	Write	HED	Write set frequency or machine speed to RAM or EEPROM. · H0000 to H9C40 (0 to 400.00Hz) : Frequency 0.01Hz increments															
Set frequency (RAM and EEPROM) *3	Write	HEE	· H0000 to H270E (0 to 9998) : Machine speed 1 increments (When Pr. 37 ≠ "0") · To change the set frequency consecutively, write data to the inverter RAM. (Instruction code: HED)															
Parameter	Read	H00 to H63	· Refer to the instruction codes in the parameter list on page 84 to read/write parameters as required. Write to Pr. 77 and Pr. 79 is disabled. When setting Pr.100 and later, set link parameter extended setting. · Set 65520 (HFFF0) as a parameter value "8888" and 65535 (HFFFF) as "9999". · When changing the parameter values frequently, set "1" in Pr. 342 to write them to the RAM. (Refer to page 110.)															
	Write	H80 to HE3																
Faults history batch clear	Write	HF4	H9696: Clears the faults history in batch.															
All parameter clear	Write	HFC	All parameters return to the initial values. Whether to clear communication parameters or not can be selected according to data. (O: Clear, x: Not clear) Refer to page 84 for parameter clear, all clear, and communication parameters. <table border="1" style="width: 100%; border-collapse: collapse;"> <thead> <tr> <th>Clear Type</th> <th>Data</th> <th>Communication Pr.</th> </tr> </thead> <tbody> <tr> <td rowspan="2">Parameter clear</td> <td>H9696</td> <td style="text-align: center;">○</td> </tr> <tr> <td>H5A5A</td> <td style="text-align: center;">x *4</td> </tr> <tr> <td rowspan="2">All parameter clear</td> <td>H9966</td> <td style="text-align: center;">○</td> </tr> <tr> <td>H55AA</td> <td style="text-align: center;">x *4</td> </tr> </tbody> </table> When clear is executed for H9696 or H9966, communication-related parameter settings also return to the initial values. When resuming operation, set the parameters again. Executing clear will clear the instruction code, HF3, and HFF settings. In the password locked status, only H9966 and H55AA (all parameter clear) are valid.	Clear Type	Data	Communication Pr.	Parameter clear	H9696	○	H5A5A	x *4	All parameter clear	H9966	○	H55AA	x *4		
Clear Type	Data	Communication Pr.																
Parameter clear	H9696	○																
	H5A5A	x *4																
All parameter clear	H9966	○																
	H55AA	x *4																

Item	Read / Write	Code Number	Description
Inverter reset	Write	HFD	H9696: Resets the inverter.
Link parameter extended setting *5	Read	H7F	Parameter settings are switched according to the H00 to H09 settings. Refer to instruction codes in the parameter list on <i>page 84</i> for the setting value details.
	Write	HFF	

- *1 When "100" is set in *Pr. 52 DU/PU main display data selection*, set frequency is monitored during a stop and output frequency is monitored during running.
- *2 Write data is hexadecimal and only lower two digits are valid. (Upper 2 digits are ignored.)
- *3 Setting from remote registers can be made.
- *4 Turning OFF the power supply while clearing parameters with H5A5A or H55AA also clears the communication parameter settings back to the initial settings.
- *5 Setting is valid only when *Pr. 544* = "0". When *Pr. 544* ≠ "0", set using RWw2 or RWw10, 12, 14, 16, or 18. (Refer to *page 62*)

• Fault data

Refer to *page 233* for details of fault definitions.

Data	Definition
H00	No alarm
H10	E.OC1
H11	E.OC2
H12	E.OC3
H20	E.OV1
H21	E.OV2
H22	E.OV3
H30	E.THT
H31	E.THM
H40	E.FIN
H52	E.ILF
H60	E.OLT
H70	E.BE
H80	E.GF
H81	E.LF
HA0	E.OPT
HA1	E.OP1

Data	Definition
HB0	E.PE
HB2	E.RET
HB3	E.PE2
HC0	E.CPU
HC5	E.IOH
HC8	E.USB
HC9	E.SAF
HD8	E.MB4
HD9	E.MB5
HDA	E.MB6
HDB	E.MB7
HF1	E.1
HF5	E.5
HF6	E.6
HF7	E.7
HFD	E.13

Fault record display example
(instruction code H74)

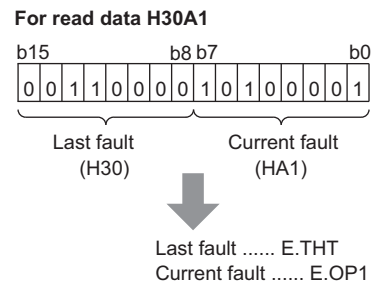

(4) Monitor codes

Monitored items can be selected with the special monitor selection No. of the instruction code and the remote registers, RWw0 and RWw4 to 7.

Divide the monitor code (RWw0) into half to select the first monitor description (RWr0) from the lower 8 bits and the second monitor description (RWr1) from the upper 8 bits.

Refer to page 176 for the details of monitors.



REMARKS

- When Pr. 544 = "12, 14, 18", descriptions of monitor codes 3 (RWw4) to 6 (RWw7) can be selected.

(Example) When output current is selected for the first monitor and output voltage is selected for the second monitor
 → monitor code is H0302

Code Number	Second Monitor Description (the upper 8 bits)	First, Third to Sixth Monitor Description (the lower 8 bits)	Increments
H00	Output frequency/machine speed *1	No monitoring (monitor value is 0)	0.01Hz/1
H01	Output frequency/machine speed *1		0.01Hz/1
H02	Output current		0.01A
H03	Output voltage		0.1V
H05	Frequency setting value/machine speed setting *1		0.01Hz/1
H07	Motor torque		0.1%
H08	Converter output voltage		0.1V
H09	Regenerative brake duty		0.1%
H0A	Electronic thermal relay function load factor		0.1%
H0B	Output current peak value		0.01A
H0C	Converter output voltage peak value		0.1V
H0E	Output power		0.01kW
H10	Output terminal status *2		—
H14	Cumulative energization time		1h
H17	Actual operation time		1h
H18	Motor load factor		0.1%
H19	Cumulative power		1kWh
H34	PID set point		0.1%
H35	PID measured value		0.1%
H36	PID deviation		0.1%
H3D	Motor thermal load factor		0.1%
H3E	Inverter thermal load factor		0.1%
H3F	Cumulative power 2		0.01kWh

*1 When Pr. 37 is not equal to "0", this will be machine speed display (1 increments).

*2 Input terminal monitor details

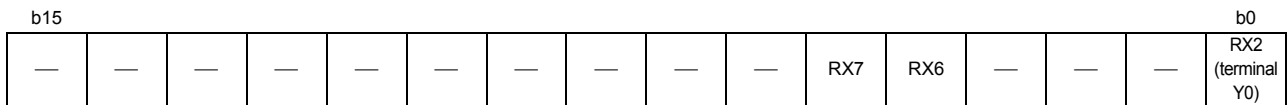

4.7 Programming examples

This chapter provides programming examples which control the inverter with sequence programs.

Item	Program Example	Refer to Page
Reading the inverter status	Reading the inverter status from the buffer memory of the master station	69
Setting the operation mode	Selecting the network operation mode	69
Setting the operation commands	Commanding the forward rotation and middle speed signals	70
Setting the monitoring function	Monitoring the output frequency	70
Reading a parameter value	Reading the value of <i>Pr. 7 Acceleration time</i>	71
Writing a parameter value	Setting "3.0s" in <i>Pr. 7 Acceleration time</i>	71
Setting the running frequency (running speed)	Setting to 50.00Hz	72
Reading the fault records	Reading the inverter faults	73
Inverter reset	Perform inverter reset at a fault occurrence.	73

(1) System configuration for programming example

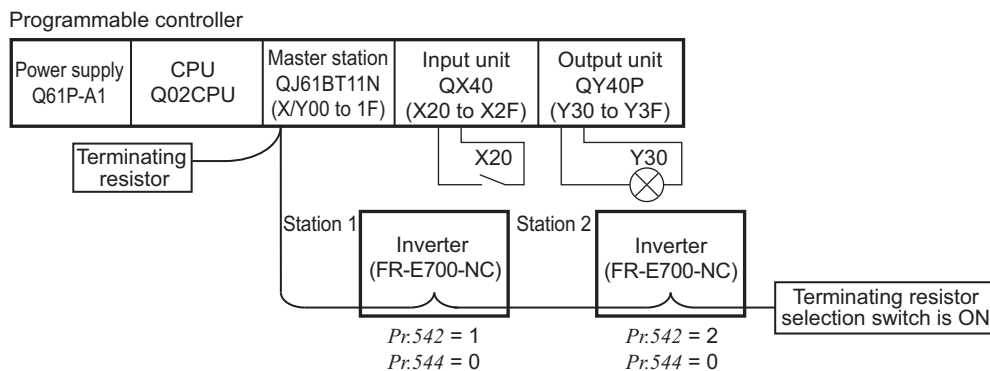

(2) Network parameter setting of the master station

Network parameters are set as below.

Item	Setting Conditions
Start I/O No.	0000
Operation settings	Data link alarm station setting
	Setting at CPU stop
Type	Master
Mode	Remote net ver.1 mode
All connect count	2
Remote input (RX)	X1000
Remote output (RY)	Y1000
Remote register (RW _r)	W0

Item	Setting Conditions
Remote register (RW _w)	W100
Special relay (SB)	SB0
Special register (SW)	SW0
Retry count	3
Automatic reconnection station count	1
CPU down select	Stop
Scan mode settings	Asynchronous
Station information	Station type
	Remote device station

(3) Remote I/O

The relation between the device of the programmable controller CPU and remote I/O (RX, RY) of the remote device station is as follows:

The devices used actually are indicated in shaded regions.

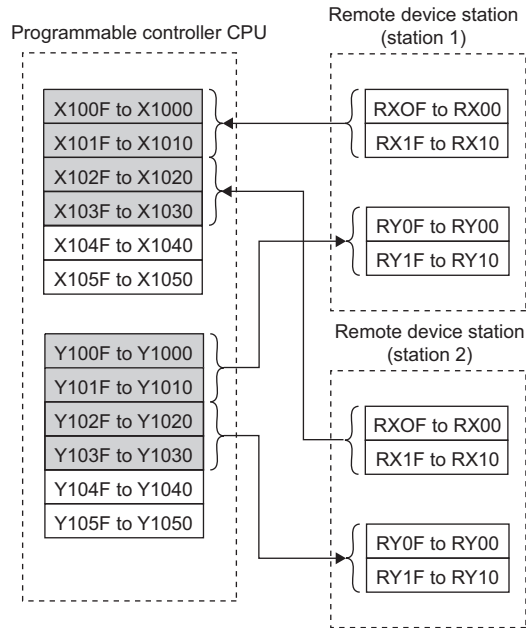

(4) Remote register

The relation between the device of the programmable controller CPU and remote register (RWw, RWr) of the remote device station is as follows:

The devices used actually are indicated in shaded regions.

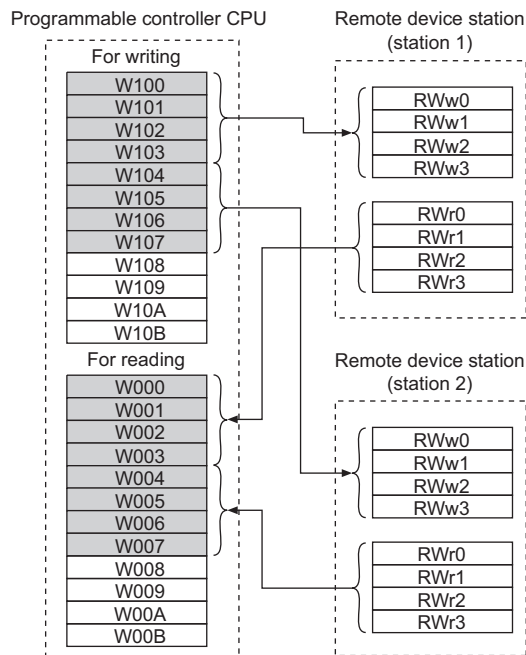

4.7.1 Programming example for reading the inverter status

The following program turns ON Y00 of the output unit when **station 1** inverter is running.

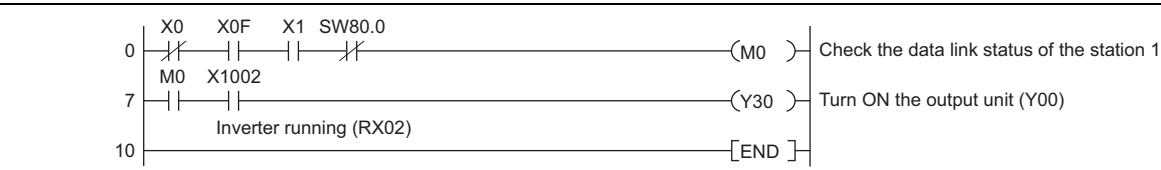

Remote input

One station	Remote input	X100F	b15	b14	b13	b12	b11	b10	b9	b8	b7	b6	b5	b4	b3	b2	b1	b0	X1000	
	RXF to RX0 RX1F to RX10		0	0	0	0	0	0	0	0	0	0	0	0	0	0	0	0	0	

[Inverter status]

Inverter status

b0 : During forward rotation
 b1 : Reverse running
 b2 : Running (terminal Y0 function) *1
 b3 : Up to frequency (SU signal) *2
 b4 : Overload alarm (OL signal) *2
 b5 : —
 b6 : Frequency detection (FU signal) *1
 b7 : Fault (ALM signal) *1
 b8 : —
 b9 : — *1
 b10 : — *1
 b11 : — *1

*1 These signals are initial values. You can change output signals using Pr: 190 to Pr: 192, Pr:313 to Pr:315 (output terminal function selection). Refer to page 167 for the details of Pr: 190 to Pr: 192 and Pr: 313 to Pr: 315 (output terminal function selection).
 *2 The signal is not changeable

4.7.2 Programming example for setting the operation mode

The following explains a program to write various data to the inverter.

The following explains a program to change the operation mode of **station 1** inverter to Network operation.

- Operation mode writing code number: HFB (hexadecimal)
- Network operation set data: H0000 (hexadecimal) (Refer to page 64)
- The reply code at the time of instruction code execution is set to D2. (Refer to page 63)

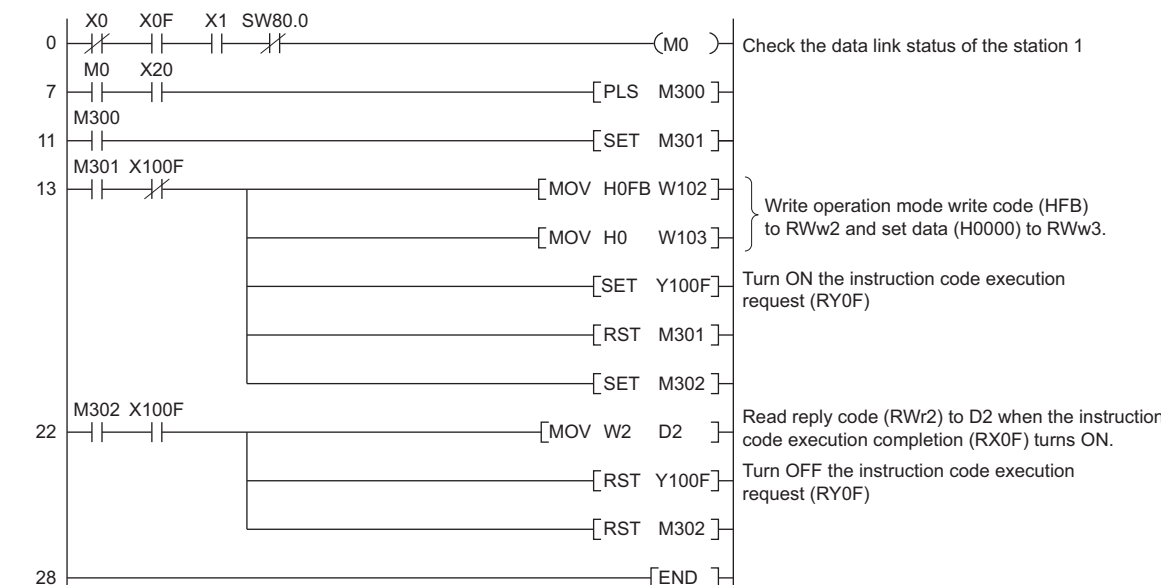

4.7.3 Programming example for setting the operation commands

The following program gives a forward command and middle speed command to **station 1** inverter

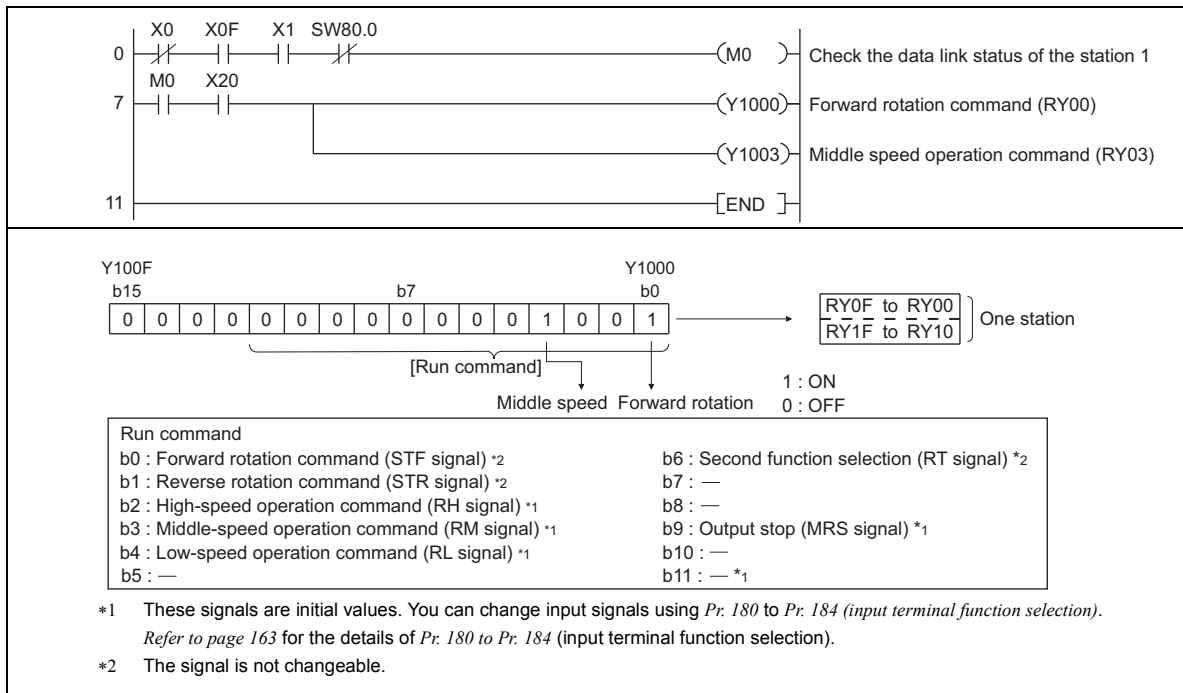

4.7.4 Programming example for monitoring the output frequency

The following explains a program to read monitor functions of the inverter.

The following program reads the output frequency of **station 1** inverter to D1.

Output frequency reading code number: H0001 (hexadecimal)

Refer to page 66 for the monitor code numbers.

(Example) The output frequency of 60Hz is indicated as H1770 (6000).

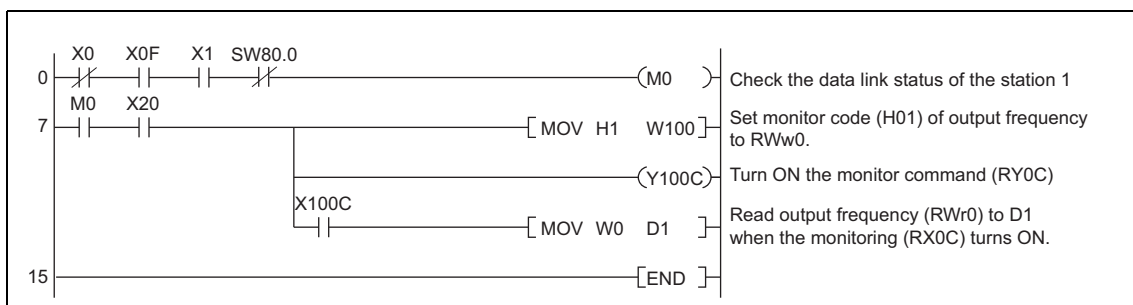

4.7.5 Programming example for parameter reading

The following program reads *Pr. 7 Acceleration time* of **station 1** inverter to D1.

- *Pr. 7 Acceleration time* reading code number: H07 (hexadecimal)
- Refer to the parameter list on page 84 to find out the code number of each parameter.
- The reply code at the time of instruction code execution is set to D2. (Refer to page 63)

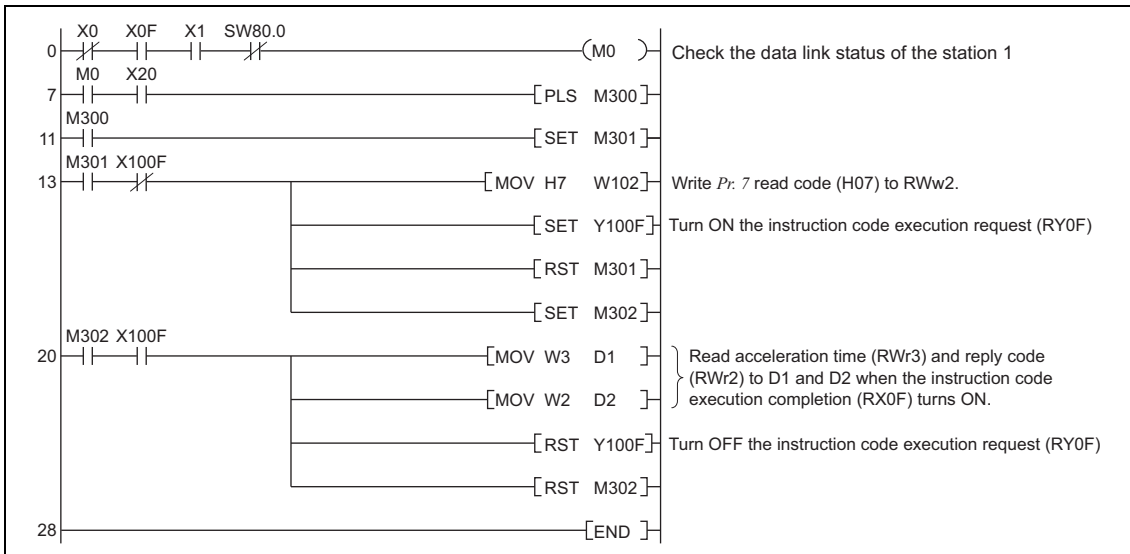

 **REMARKS**

- For parameters having numbers 100 and later, change their link parameter extended settings (set them to other than H0000). Refer to the parameter list on page 84 for the setting values.

4.7.6 Programming example for parameter writing

The following program changes the setting of *Pr.7 Acceleration time* of **station 1** inverter to 3.0s.

- Acceleration time writing code number: H87 (hexadecimal)
- Acceleration time set data: K30 (decimal)

Refer to the parameter list on page 84 to find out the code number of each parameter.

The reply code at the time of instruction code execution is set to D2. (Refer to page 63)

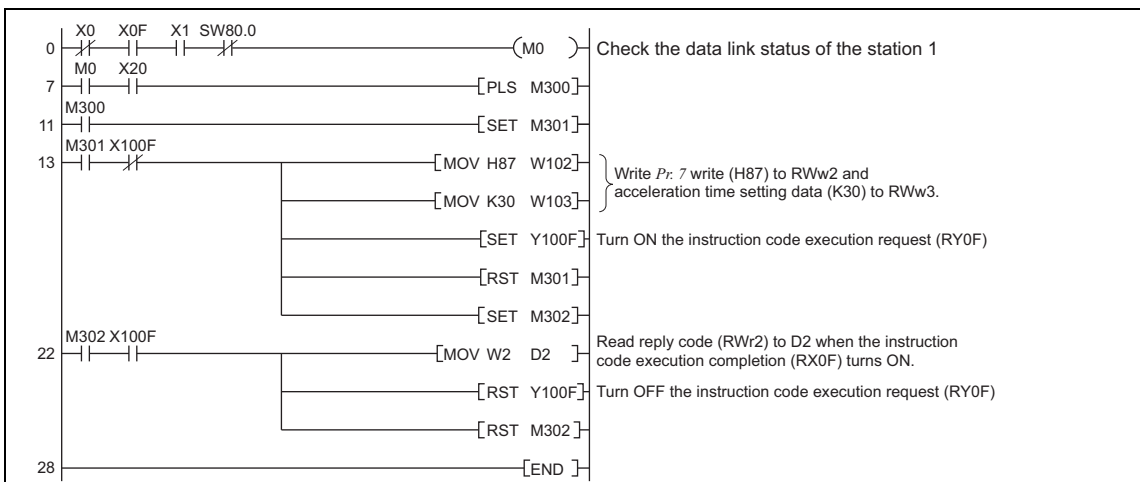

 **REMARKS**

- For parameters having numbers 100 and later, change their link parameter extended settings (set them to other than H0000). Refer to the parameter list on page 84 for the setting values.
- For other functions, refer to the instruction codes (page 64).

4.7.7 Programming example for setting the running frequency

- 1) The following program example changes the running frequency of **station 1** inverter to 50.00Hz
 Set frequency: K5000 decimal
 The reply code at the time of instruction code execution is set to D2. (Refer to page 63)

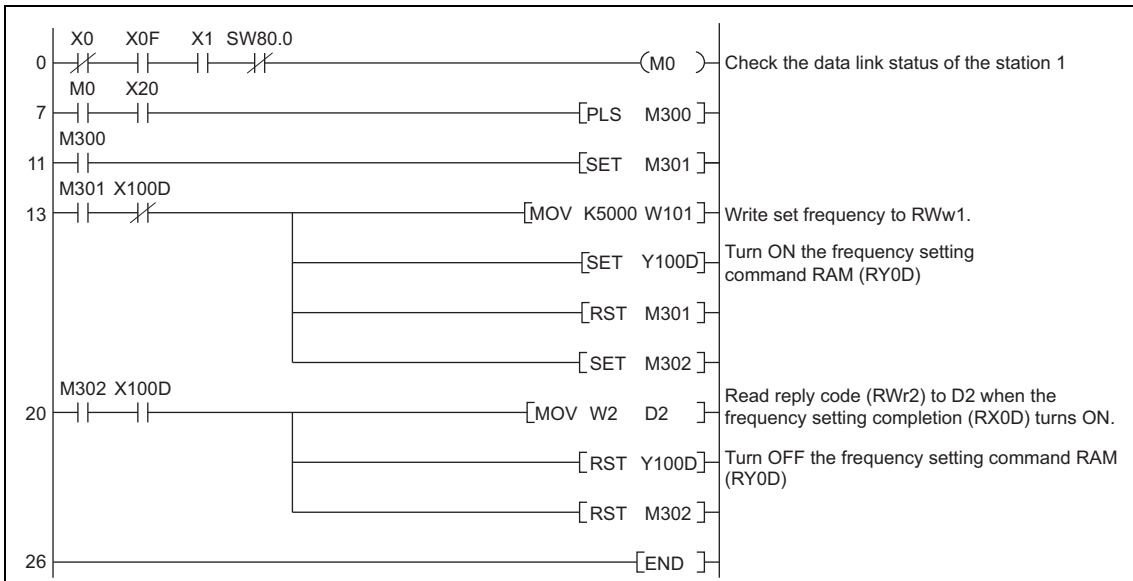

- 2) To continuously change the running frequency from the programmable controller
 When the frequency (speed) setting completion (example: X100D) switches ON, make sure that the reply code in the remote register is 0000H and change the set data (example: W101) continuously.
- 3) Program example for writing data to EEPROM
 Change the following points in the program shown above.
 Frequency setting command Y100D → Y100E
 Frequency setting completion X100D → X100E

<Timing chart when writing to RAM>

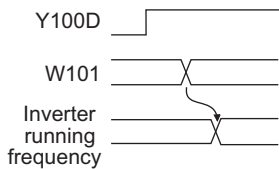

<Timing chart when writing to EEPROM>

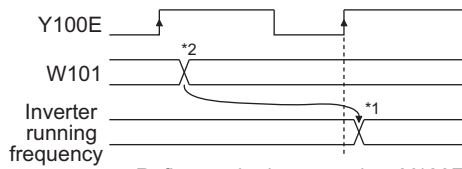

Reflect to the inverter when Y100E turns ON

*1 For EEPROM, write is made only once when Y100E is switched ON.
 *2 If the set data is changed with Y100E ON, it is not reflected on the inverter.

4.7.8 Programming example for fault record reading

The following program reads fault records of **station 1** inverter to D1.

· Faults history No. 1, No. 2 reading code number: H74 (hexadecimal)

For the error code numbers, refer to page 65.

The reply code at the time of instruction code execution is set to D2. (Refer to page 63)

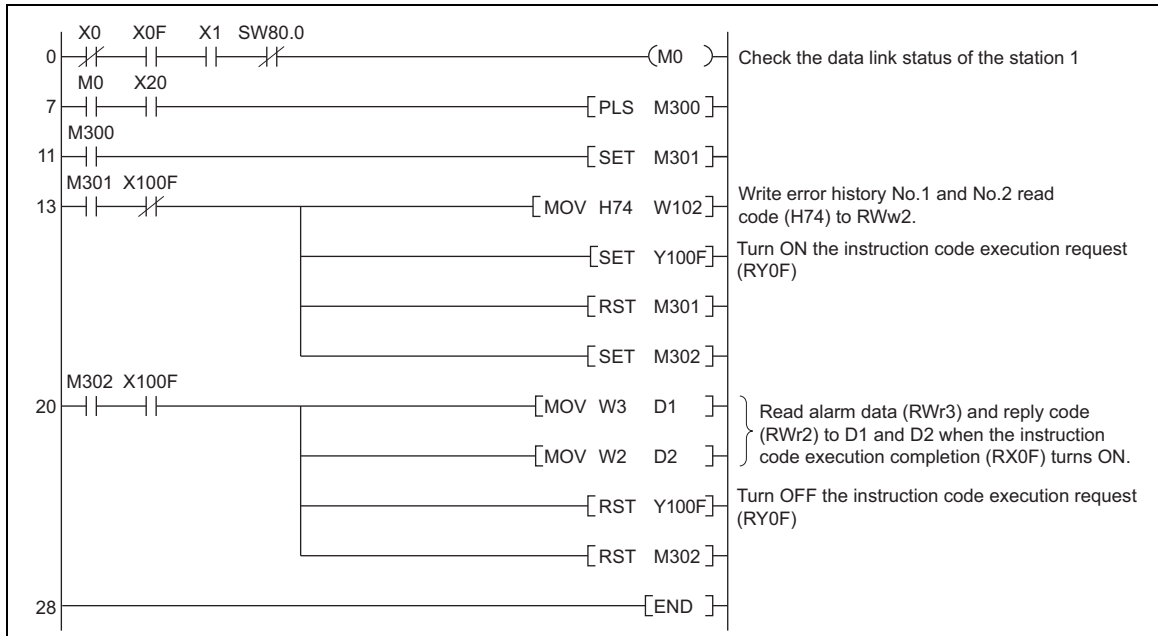

4.7.9 Programming example for resetting the inverter at inverter error

The following is a program example for resetting **station 1** inverter at inverter error.

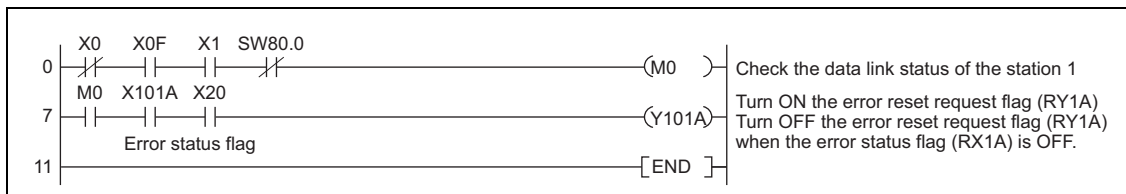

REMARKS

- The above inverter reset using RY1A is available only when an inverter error occurs.
When Pr. 349 Communication reset selection = "0", inverter reset is available independently of the operation mode.
- Select Network operation mode to reset the inverter by setting data (H9696) in the instruction code (HFD) and then turn ON the instruction code execution request (RYF). (Refer to page 69 for programming examples.)
- Refer to page 110 for operation conditions of inverter reset.

4.7.10 Instructions

(1) Programming instructions

- Since the buffer memory data of the master station is kept transferred (refreshed) to/from the inverters, the TO instruction need not be executed every scan in response to data write or read requests. The execution of the TO instruction every scan does not pose any problem.
- If the FROM/TO instruction is executed frequently, data may not be written reliably. When transferring data between the inverter and sequence program via the buffer memory, perform the handshake to confirm that data has been written without error.

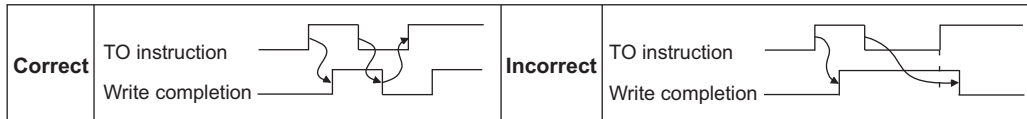

(2) Operating and handling instructions

- Commands only from the programmable controller can be accepted during operation from CC-Link communication. Operation commands from the operation panel are ignored.
- If different devices have the same station number, data is transmitted improperly, and the communication cannot be performed properly.
- The inverter trips with the fault "E.OP1" if data communication stops for more than the time set in *Pr. 500 Communication error execution waiting time* due to a programmable controller fault, an open CC-Link dedicated cable, etc. during CC-Link operation.
- If the programmable controller (master station) is reset during CC-Link operation or if the programmable controller is powered OFF, data communication stops and the inverter trips with fault "E.OP1". To reset the programmable controller (master station), choose the operation mode other than Network operation mode beforehand.

(3) Troubleshooting

1) Operation mode does not switch to the Network operation mode

- Check that CC-Link dedicated cable is fitted properly. (Check for contact fault, break in the cable, etc.)
- Check that *Pr.542 Communication station number (CC-Link)* is set correctly. (Check that the station number matches the program, the station numbers are not repeated, and the station number is not outside the range.)
- Check that the operation mode switching program is running.
- Check that the operation mode switching program has been written correctly.

2) Inverter does not start in the Network operation mode

- Check that the inverter starting program has been written correctly.
- Check that the inverter starting program is running.

4.8 How to check for error using the LEDs

4.8.1 Operation status indication LEDs

LED	Description
L.RUN	Lit when refresh data is properly received. Turns OFF when a data transmission is stopped for a certain period of time.
L.ERR	<ul style="list-style-type: none"> Lit when a communication error occurs in the own station and flickers when settings of switch, etc. are changed while power is ON. Flickers when the Pr. 542 or Pr. 543 setting is changed. Reset the inverter by turning the power OFF then back ON, or through CC-Link communication. (Refer to page 232.)
RUN	Lit during normal operation (5V is supplied in the board) (Lit even in the noncommunication status.) Flickers when the master station is CC-Link Ver.1 and FR-E700-NC is CC-Link Ver. 2 compatible. (Refer to page 48.)
SD	Turns OFF when no data is transmitted.
RD	Lit when the received data carrier is detected.

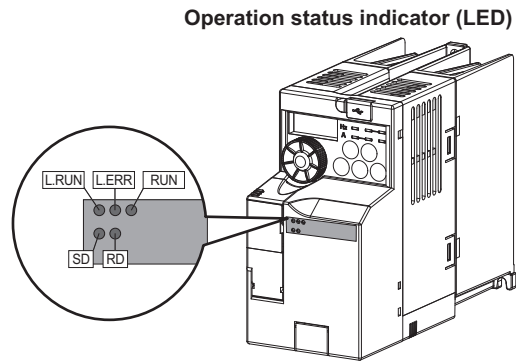

REMARKS

- Set the station number with Pr. 542 Communication station number (CC-Link), the transmission baud rate with Pr.543 Baud rate selection (CC-Link). (Refer to page 105.)

4.8.2 When one inverter is connected

The following table shows how the cause of a fault can be determined with the inverter's (FR-E700-NC) LED statuses in a system configuration that has one inverter.

(In this example, assume SW, M/S, and PRM LEDs of the master module are OFF (master module is in normal operation).)

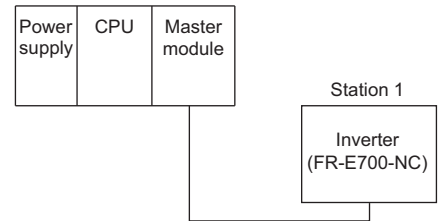

LED status					Cause
RUN	L.RUN	SD	RD	L.ERR	
●	●	◎	◎	◎	Normal communication is made but CRC error has occurred due to noise.
●	●	◎	◎	○	Normal communication
●	●	◎	○	◎	Hardware fault
●	●	◎	○	○	Hardware fault
●	●	○	◎	◎	Cannot answer due to CRC error of receive data.
●	●	○	◎	○	Data sent to the host station does not reach destination.
●	●	○	○	◎	Hardware fault
●	●	○	○	○	Hardware fault
●	○	◎	◎	◎	Polling response is made but refresh receive is in CRC error.
●	○	◎	◎	○	Hardware fault
●	○	◎	○	◎	Hardware fault
●	○	◎	○	○	Hardware fault
●	○	○	◎	◎	Data sent to the host station is in CRC error.
●	○	○	◎	○	There is no data sent to the host station, or data sent to the host station cannot be received due to noise.
●	○	○	○	◎	Hardware fault
●	○	○	○	○	Cannot receive data due to break in the cable, etc.
●	○	○	◎○	●	Invalid baud rate or station number setting
●	●	◎	◎	◎	Baud rate or station number changed during operation.
○	○	○	○	○	Watchdog fault (hardware fault), power disconnection, faulty power supply area
◎	—	—	—	—	Master station is connected to CC-Link Ver. 1 and FR-E700-NC is connected to CC-Link Ver. 2.

●: ON, ○: OFF, ◎: Flicker

4.8.3 When two or more inverters are connected

The following table shows how the cause of a fault can be determined with the inverter's (FR-E700-NC) LED statuses in the system configuration shown below.

(In this example, assume SW, M/S, PRM LEDs of the master module are OFF. (The master module is in normal operation.))

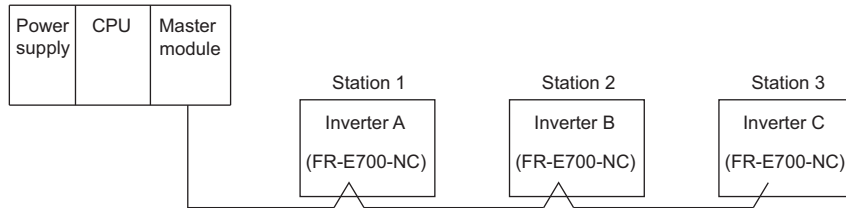

Master Module	LED Status			Cause	Corrective Action
	Inverters (FR-E700-NC)				
	Station1	Station2	Station3		
	RUN ● L.RUN ● SD ● RD ● L.ERR ○	RUN ● L.RUN ● SD ● RD ● L.ERR ○	RUN ● L.RUN ● SD ● RD ● L.ERR ○	Normal	—
	RUN ○ L.RUN ○ SD ○ RD ○ L.ERR ○	RUN ● L.RUN ● SD ● RD ● L.ERR ○	RUN ● L.RUN ● SD ● RD ● L.ERR ○	CC-Link communication circuit in the inverter is faulty.	Please contact your sales representative.
TIME LINE or TIME LINE	RUN ● L.RUN ● SD ● RD ● L.ERR ○	RUN ● L.RUN ○ SD * RD * L.ERR ○	RUN ● L.RUN ○ SD * RD * L.ERR ○	L.RUN is OFF at the station 2 inverter and the subsequent inverters. This indicates that the CC-Link dedicated cable has a break between the inverters A and B, or the CC-Link communication connector has come off from the inverter A or B.	Referring to the LED "ON" condition, search for an open point and repair.
	RUN ● L.RUN ○ SD * RD * L.ERR ○	RUN ● L.RUN ○ SD * RD * L.ERR ○	RUN ● L.RUN ○ SD * RD * L.ERR ○	The CC-Link dedicated cable is shorted.	Identify the shorted wire out of the three wires (blue, white, yellow) of the CC-Link dedicated cable, and repair the wire.
	RUN ● L.RUN ○ SD * RD * L.ERR *	RUN ● L.RUN ○ SD * RD * L.ERR *	RUN ● L.RUN ○ SD * RD * L.ERR *	The CC-Link dedicated cable is connected incorrectly.	Check if the three wires (blue, white, yellow) of the CC-Link dedicated cable are correctly inserted to the one-touch communication connector plug. If any improper connection is found, correct the connection. (Refer to page 51.)

●: ON, ○: OFF, ◎: Flicker, *: Any of ON, flicker or OFF

4.8.4 Communication stops during operation

- Check that CC-Link dedicated cable is fitted properly. (Check for contact fault, break in the cable, etc.)
- Check that the programmable controller program is executed properly.
- Check that data communication has not stopped due to an instantaneous power failure, etc.

		LED States						Cause	Corrective Action									
Master Module		Inverters (FR-E700-NC)																
		Station 1		Station 2		Station 3												
TIME LINE or TIME LINE	○	RUN ●	L.RUN ○	SD *	RD ●	L.ERR ○	RUN ●	L.RUN ●	SD ●	RD ●	L.ERR ○	RUN ●	L.RUN ○	SD *	RD ●	L.ERR ○	Since the L.RUN LEDs of the inverter on station 1 and the inverter on station 3 are OFF, the station numbers of the inverters set as stations 1 and 3 are the same.	After correcting the repeated station numbers of the inverters using Pr. 542 Communication station number (CC-Link), switch power ON again.
	○	RUN ●	L.RUN ●	SD ●	RD ●	L.ERR ○	RUN ●	L.RUN ○	SD ○	RD ●	L.ERR ○	RUN ●	L.RUN ●	SD ●	RD ●	L.ERR ○	Since the L.RUN and SD LEDs of the inverter on station 2 are OFF, the transmission speed setting of the inverter on station 2 is wrong within the setting range (0 to 4).	After correcting the transmission speed setting using Pr. 543 Baud rate selection (CC-Link), switch power on again.
	○	RUN ●	L.RUN ●	SD ●	RD ●	L.ERR ○	RUN ●	L.RUN ●	SD ●	RD ●	L.ERR ○	RUN ●	L.RUN ●	SD ●	RD ●	L.ERR ◎	Since the L.ERR LED on the inverter on station 3 flickers, the station number setting of the inverter on station 3 is changed during normal operation, or the transmission speed is changed during normal operation.	After setting back Pr.542 Communication station number (CC-Link) and Pr.543 Baud rate selection (CC-Link) to their original settings, power ON the inverter again.
TIME LINE or TIME LINE	●	RUN ●	L.RUN ●	SD ●	RD ●	L.ERR ○	RUN ●	L.RUN ●	SD ●	RD ●	L.ERR ●	RUN ●	L.RUN ●	SD ●	RD ●	L.ERR ○	Since the L.ERR LED of the inverter on station 2 is ON, the inverter itself on station 1 is affected by noise. (L.RUN may go OFF.)	Securely earth (ground) each inverter and the master module.
	●	RUN ●	L.RUN ●	SD ●	RD ●	L.ERR ○	RUN ●	L.RUN ●	SD ●	RD ●	L.ERR ●	RUN ●	L.RUN ●	SD ●	RD ●	L.ERR ●	Since the L.ERR LEDs of the inverter on station 2 and later are ON, the transmission cable between the inverters of stations 2 and 3 is affected by noise. (L.RUN may go OFF.)	Check if shielding wires of the CC-Link dedicated cable are properly inserted to the one-touch communication connector plug. (Refer to page 51.) Place the CC-Link dedicated cable as far as possible from the power cable. (100mm or more)
	●	RUN ●	L.RUN ●	SD ●	RD ●	L.ERR ○	RUN ●	L.RUN ●	SD ●	RD ●	L.ERR ●	RUN ●	L.RUN ●	SD ●	RD ●	L.ERR ●	The plug-in terminating resistor selection switch (SW1) has been left unset, or the one-touch connector plug with terminating resistor has been left unfitted. (L.RUN may go OFF.)	Check the setting of the terminating resistor selection switch (SW1). (Refer to page 50.) Use the one-touch connector plug with terminating resistor. (Refer to page 53.)

●: ON, ○: OFF, ◎: Flicker, *: Any of ON, flicker or OFF

MEMO

5 PARAMETERS

This chapter explains the "PARAMETERS" for use of this product.

Always read the instructions before using the equipment.

The following marks are used to indicate the controls as below.

V/F control

Advanced magnetic flux vector control

General-purpose magnetic flux vector control

(Parameters without any mark are valid for all controls.)

1

2

3

4

5

6

7

8

5.1 Operation panel

5.1.1 Names and functions of the operation panel

The operation panel cannot be removed from the inverter.

Operation mode indicator
 PU: Lit to indicate PU operation mode.
 EXT: Not used.
 NET: Lit to indicate Network operation mode. (Lit at power-ON at initial setting.)

Operating status indicator
 Lit or flicker during inverter operation. *
 * Lit: When the forward rotation operation is being performed.
 Slow flickering (1.4s cycle):
 When the reverse operation is being performed.
 Fast flickering (0.2s cycle):
 When **RUN** was pressed or the start command was given, but the operation cannot be made.
 •When the frequency command is less than the starting frequency.
 •When the MRS signal is input.

Unit indicator
 Hz: Lit to indicate frequency. (Flickers when the set frequency monitor is displayed.)
 A: Lit to indicate current. (Both "Hz" and "A" turn OFF when other than the above is displayed.)

Parameter setting mode
 Lit to indicate parameter setting mode.

Monitor (4-digit LED)
 Shows the frequency, parameter number, etc.

Monitor indicator
 Lit to indicate monitoring mode.

Setting dial
 (Setting dial: Mitsubishi inverter dial)
 Used to change the frequency setting and parameter settings.
 Press to display the following.
 • Displays the set frequency in the monitor mode
 • Displays the order in the faults history mode

Stop operation
 Used to stop Run command.
 Fault can be reset when protective function is activated (fault).

Mode switchover
 Used to change each setting mode.
 Pressing for a while (2s) can lock operation.
 (Refer to page 224)

Operation mode switchover
 Used to switch between the NET and PU operation modes (valid when Pr.79 = "0")
 It also cancels the PU stop.
 (Refer to page 194)

Determination of each setting
 If pressed during operation, monitor changes as below;

```

            graph TD
            A[Running frequency] --> B[Output current]
            B --> C[Output voltage]
            C --> A
            
```

Start command
 The rotation direction can be selected by setting Pr. 40.

5.1.2 Basic operation (factory setting)

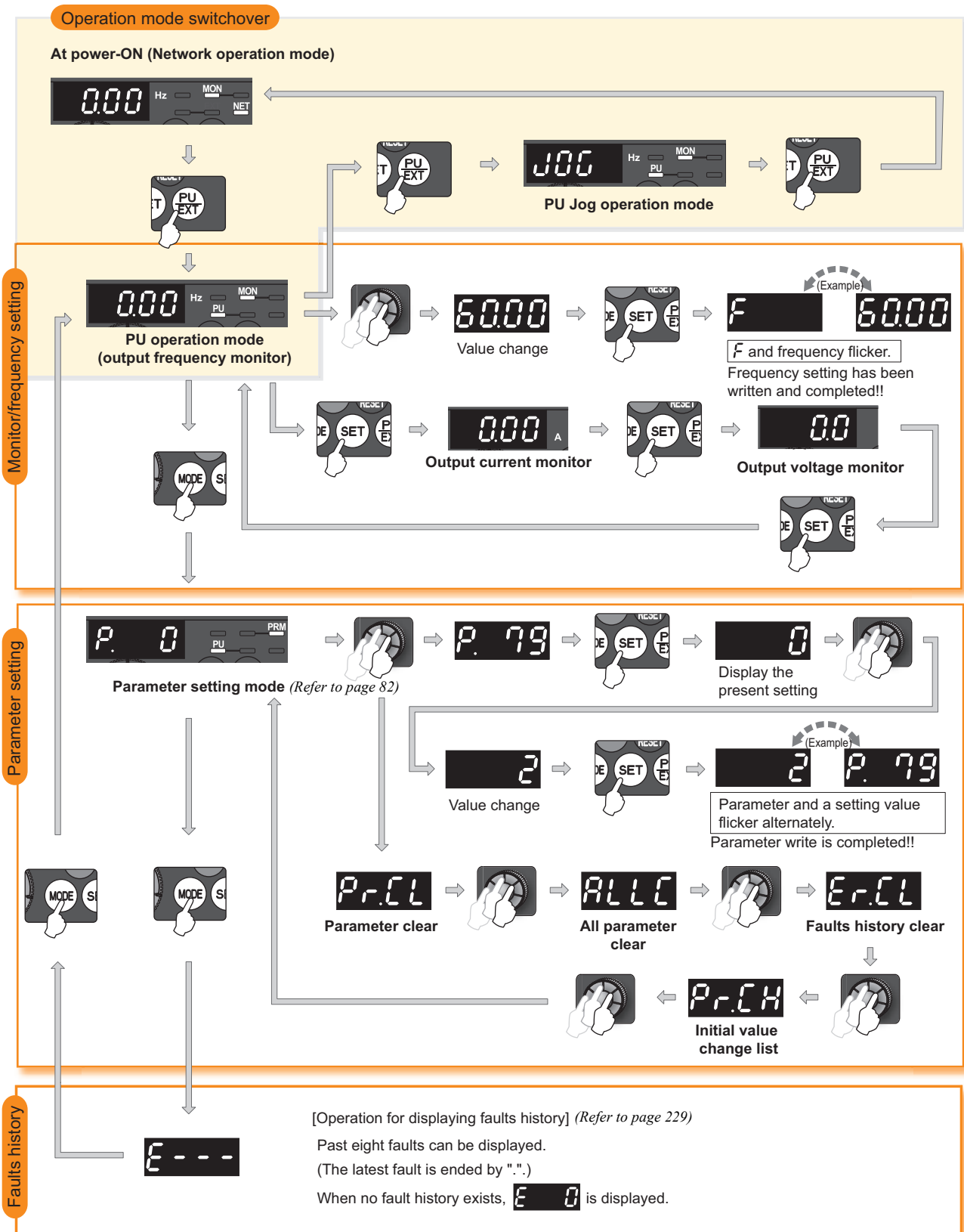

5.1.3 Changing the parameter setting value

Changing example

Change the Pr. 1 Maximum frequency setting.

Operation

1. Screen at power-ON
The inverter starts up in Network operation mode.
The monitor display appears.
2. Press **PU/EXT** to choose the PU operation mode.
3. Press **MODE** to choose the parameter setting mode.
4. Turn **▲** until **P. 1** (Pr. 1) appears.
5. Press **SET** to read the currently set value.
"1200" (120.0Hz (initial value)) appears.
6. Turn **▲** to change the set value to "6000" (60.00Hz).
7. Press **SET** to set.

Display



PU indicator is lit.



PRM indicator is lit.



(The parameter number read previously appears.)



Flicker...Parameter setting complete!!

- Turn **▲** to read another parameter.
- Press **SET** to show the setting again.
- Press **SET** twice to show the next parameter.
- Press **MODE** twice to return the monitor to frequency monitor.

REMARKS

? **Er 1**, **Er 2**, **Er 4** is displayed...Why?

- Er 1** appears Write disable error
- Er 2** appears Write error during operation
- Er 4** appears Mode designation error

(For details, refer to page 234.)

- The number of digits displayed on the operation panel is four. Only the upper four digits of values can be displayed and set. If the values to be displayed have five digits or more including decimal places, the fifth or later numerals cannot be displayed nor set.
(Example) For Pr. 1
When 60Hz is set, 60.00 is displayed.
When 120Hz is set, 120.0 is displayed and second decimal place is not displayed nor set.

5.1.4 Setting dial push

Push the setting dial () to display the set frequency* currently set.

* Appears when PU operation mode is selected.

5.2 Parameter list

5.2.1 Parameter list

For simple variable-speed operation of the inverter, the initial setting of the parameters may be used as they are. Set the necessary parameters to meet the load and operational specifications. Parameter setting, change and check are available from the operation panel.

REMARKS

-  indicates simple mode parameters. (Initially set to extended mode)
- The parameters surrounded by a black border in the table allow their settings to be changed during operation even if "0" (initial value) is set in Pr. 77 Parameter write selection. (Note that the Pr. 77 setting cannot be changed through the CC-Link communication.)

Function	Parameter	Name	Setting Range	Minimum Setting Increments	Initial Value	Refer to Page	Customer Setting
Basic functions	0	Torque boost	0 to 30%	0.1%	6/4/3/2% *1	113	
	1	Maximum frequency	0 to 120Hz	0.01Hz	120Hz	124	
	2	Minimum frequency	0 to 120Hz	0.01Hz	0Hz	124	
	3	Base frequency	0 to 400Hz	0.01Hz	60Hz	126	
	4	Multi-speed setting (high speed)	0 to 400Hz	0.01Hz	60Hz	130	
	5	Multi-speed setting (middle speed)	0 to 400Hz	0.01Hz	30Hz	130	
	6	Multi-speed setting (low speed)	0 to 400Hz	0.01Hz	10Hz	130	
	7	Acceleration time	0 to 3600/360s	0.1/0.01s	5/10/15s *2	135	
	8	Deceleration time	0 to 3600/360s	0.1/0.01s	5/10/15s *2	135	
	9	Electronic thermal O/L relay	0 to 500A	0.01A	Rated inverter current	142	
DC injection brake	10	DC injection brake operation frequency	0 to 120Hz	0.01Hz	3Hz	154	
	11	DC injection brake operation time	0 to 10s	0.1s	0.5s	154	
	12	DC injection brake operation voltage	0 to 30%	0.1%	6/4/2% *3	154	
—	13	Starting frequency	0 to 60Hz	0.01Hz	0.5Hz	138	
—	14	Load pattern selection	0 to 3	1	0	128	
JOG operation	15	Jog frequency	0 to 400Hz	0.01Hz	5Hz	201	
	16	Jog acceleration/deceleration time	0 to 3600/360s	0.1/0.01s	0.5s	201	
—	17	MRS input selection	0, 2, 4	1	0	166	
—	18	High speed maximum frequency	120 to 400Hz	0.01Hz	120Hz	124	
—	19	Base frequency voltage	0 to 1000V, 8888, 9999	0.1V	9999	126	
Acceleration/deceleration time	20	Acceleration/deceleration reference frequency	1 to 400Hz	0.01Hz	60Hz	135	
	21	Acceleration/deceleration time increments	0, 1	1	0	135	
Stall prevention	22	Stall prevention operation level	0 to 200%	0.1%	150%	120	
	23	Stall prevention operation level compensation factor at double speed	0 to 200%, 9999	0.1%	9999	120	
Multi-speed setting	24	Multi-speed setting (speed 4)	0 to 400Hz, 9999	0.01Hz	9999	130	
	25	Multi-speed setting (speed 5)	0 to 400Hz, 9999	0.01Hz	9999	130	
	26	Multi-speed setting (speed 6)	0 to 400Hz, 9999	0.01Hz	9999	130	
	27	Multi-speed setting (speed 7)	0 to 400Hz, 9999	0.01Hz	9999	130	

- These instruction codes are used for parameter read and write by using CC-Link communication. (Refer to the Chapter 4 for CC-Link communication)
- "O" indicates valid and "x" indicates invalid of "control mode-based correspondence", "parameter clear", and "all parameter clear".

Parameter	Instruction Code			Control Mode-based Correspondence			Parameter	
	Read	Write	Extended	V/F	AD MFVC	GP MFVC	Clear	All clear
0	00	80	0	O	x	x	O	O
1	01	81	0	O	O	O	O	O
2	02	82	0	O	O	O	O	O
3	03	83	0	O	x	x	O	O
4	04	84	0	O	O	O	O	O
5	05	85	0	O	O	O	O	O
6	06	86	0	O	O	O	O	O
7	07	87	0	O	O	O	O	O
8	08	88	0	O	O	O	O	O
9	09	89	0	O	O	O	O	O
10	0A	8A	0	O	O	O	O	O
11	0B	8B	0	O	O	O	O	O
12	0C	8C	0	O	O	O	O	O
13	0D	8D	0	O	O	O	O	O
14	0E	8E	0	O	x	x	O	O
15	0F	8F	0	O	O	O	O	O
16	10	90	0	O	O	O	O	O
17	11	91	0	O	O	O	O	O
18	12	92	0	O	O	O	O	O
19	13	93	0	O	x	x	O	O
20	14	94	0	O	O	O	O	O
21	15	95	0	O	O	O	O	O
22	16	96	0	O	O	O	O	O
23	17	97	0	O	O	O	O	O
24	18	98	0	O	O	O	O	O
25	19	99	0	O	O	O	O	O
26	1A	9A	0	O	O	O	O	O
27	1B	9B	0	O	O	O	O	O

Function	Parameter	Name	Setting Range	Minimum Setting Increments	Initial Value	Refer to Page	Customer Setting	
—	29	Acceleration/deceleration pattern selection	0, 1, 2	1	0	139		
—	30	Regenerative function selection	0, 1, 2	1	0	155, 180		
Frequency jump	31	Frequency jump 1A	0 to 400Hz, 9999	0.01Hz	9999	125		
	32	Frequency jump 1B	0 to 400Hz, 9999	0.01Hz	9999	125		
	33	Frequency jump 2A	0 to 400Hz, 9999	0.01Hz	9999	125		
	34	Frequency jump 2B	0 to 400Hz, 9999	0.01Hz	9999	125		
	35	Frequency jump 3A	0 to 400Hz, 9999	0.01Hz	9999	125		
—	36	Frequency jump 3B	0 to 400Hz, 9999	0.01Hz	9999	125		
—	37	Speed display	0, 0.01 to 9998	0.001	0	175		
—	40	RUN key rotation direction selection	0, 1	1	0	223		
Frequency detection	41	Up-to-frequency sensitivity	0 to 100%	0.1%	10%	171		
	42	Output frequency detection	0 to 400Hz	0.01Hz	6Hz	171		
	43	Output frequency detection for reverse rotation	0 to 400Hz, 9999	0.01Hz	9999	171		
Second functions	44	Second acceleration/deceleration time	0 to 3600/360s	0.1/0.01s	5/10/15s *2	135		
	45	Second deceleration time	0 to 3600/360s, 9999	0.1/0.01s	9999	135		
	46	Second torque boost	0 to 30%, 9999	0.1%	9999	113		
	47	Second V/F (base frequency)	0 to 400Hz, 9999	0.01Hz	9999	126		
	48	Second stall prevention operation current	0 to 200%, 9999	0.1%	9999	120		
—	51	Second electronic thermal O/L relay	0 to 500A, 9999	0.01A	9999	142		
—	52	DU/PU main display data selection	0, 5, 7 to 12, 14, 20, 23 to 25, 52 to 57, 61, 62, 100	1	0	176		
—	54	Parameter for manufacturer setting. Do not set.						
—	55	Parameter for manufacturer setting. Do not set.						
—	56	Parameter for manufacturer setting. Do not set.						
Automatic restart functions	57	Restart coasting time	0, 0.1 to 5s, 9999	0.1s	9999	180		
	58	Restart cushion time	0 to 60s	0.1s	1s	180		
—	59	Remote function selection	0, 1, 2, 3	1	0	132		
—	60	Energy saving control selection	0, 9	1	0	191		
Automatic acceleration /deceleration	61	Reference current	0 to 500A, 9999	0.01A	9999	140		
	62	Reference value at acceleration	0 to 200%, 9999	1%	9999	140		
	63	Reference value at deceleration	0 to 200%, 9999	1%	9999	140		
—	65	Retry selection	0 to 5	1	0	188		
—	66	Stall prevention operation reduction starting frequency	0 to 400Hz	0.01Hz	60Hz	120		
Retry	67	Number of retries at fault occurrence	0 to 10, 101 to 110	1	0	188		
	68	Retry waiting time	0.1 to 360s	0.1s	1s	188		
	69	Retry count display erase	0	1	0	188		
—	70	Special regenerative brake duty	0 to 30%	0.1%	0%	155		
—	71	Applied motor	0, 1, 3 to 6, 13 to 16, 23, 24, 40, 43, 44, 50, 53, 54	1	0	114, 117, 144, 146,		
—	72	PWM frequency selection	0 to 15	1	1	192		
—	73	Parameter for manufacturer setting. Do not set.						
—	74	Parameter for manufacturer setting. Do not set.						
—	75	Reset selection/PU stop selection	0 to 3, 14 to 17	1	14	194		

Parameter	Instruction Code			Control Mode-based Correspondence			Parameter	
	Read	Write	Extended	V/F	AD MFVC	GP MFVC	Clear	All clear
29	1D	9D	0	○	○	○	○	○
30	1E	9E	0	○	○	○	○	○
31	1F	9F	0	○	○	○	○	○
32	20	A0	0	○	○	○	○	○
33	21	A1	0	○	○	○	○	○
34	22	A2	0	○	○	○	○	○
35	23	A3	0	○	○	○	○	○
36	24	A4	0	○	○	○	○	○
37	25	A5	0	○	○	○	○	○
40	28	A8	0	○	○	○	○	○
41	29	A9	0	○	○	○	○	○
42	2A	AA	0	○	○	○	○	○
43	2B	AB	0	○	○	○	○	○
44	2C	AC	0	○	○	○	○	○
45	2D	AD	0	○	○	○	○	○
46	2E	AE	0	○	×	×	○	○
47	2F	AF	0	○	×	×	○	○
48	30	B0	0	○	○	○	○	○
51	33	B3	0	○	○	○	○	○
52	34	B4	0	○	○	○	○	○
54	Parameter for manufacturer setting. Do not set.							
55	Parameter for manufacturer setting. Do not set.							
56	Parameter for manufacturer setting. Do not set.							
57	39	B9	0	○	○	○	○	○
58	3A	BA	0	○	○	○	○	○
59	3B	BB	0	○	○	○	○	○
60	3C	BC	0	○	×	×	○	○
61	3D	BD	0	○	○	○	○	○
62	3E	BE	0	○	○	○	○	○
63	3F	BF	0	○	○	○	○	○
65	41	C1	0	○	○	○	○	○
66	42	C2	0	○	○	○	○	○
67	43	C3	0	○	○	○	○	○
68	44	C4	0	○	○	○	○	○
69	45	C5	0	○	○	○	○	○
70	46	C6	0	○	○	○	○	○
71	47	C7	0	○	○	○	○	○
72	48	C8	0	○	○	○	○	○
73	Parameter for manufacturer setting. Do not set.							
74	Parameter for manufacturer setting. Do not set.							
75	4B	CB	0	○	○	○	×	×

Function	Parameter	Name	Setting Range	Minimum Setting Increments	Initial Value	Refer to Page	Customer Setting
—	77	Parameter write selection	0, 1, 2	1	0	196	
—	78	Reverse rotation prevention selection	0, 1, 2	1	0	197	
—	⊙ 79	Operation mode selection	0, 1, 2, 3, 4, 6, 7	1	0	103	
Motor constants	80	Motor capacity	0.1 to 15kW, 9999	0.01kW	9999	112, 114, 117, 146	
	81	Number of motor poles	2, 4, 6, 8, 10, 9999	1	9999	112, 114, 117, 146	
	82	Motor excitation current	0 to 500A (0 to ****), 9999 *5	0.01A (1) *5	9999	146	
	83	Rated motor voltage	0 to 1000V	0.1V	200V/400V *4	146	
	84	Rated motor frequency	10 to 120Hz	0.01Hz	60Hz	146	
	89	Speed control gain (Advanced magnetic flux vector)	0 to 200%, 9999	0.1%	9999	114	
	90	Motor constant (R1)	0 to 50Ω (0 to ****), 9999 *5	0.001Ω (1) *5	9999	146	
	91	Motor constant (R2)	0 to 50Ω (0 to ****), 9999 *5	0.001Ω (1) *5	9999	146	
	92	Motor constant (L1)	0 to 1000mH (0 to 50Ω, 0 to ****), 9999 *5	0.1mH (0.001Ω, 1) *5	9999	146	
	93	Motor constant (L2)	0 to 1000mH (0 to 50Ω, 0 to ****), 9999 *5	0.1mH (0.001Ω, 1) *5	9999	146	
94	Motor constant (X)	0 to 100% (0 to 500Ω, 0 to ****), 9999 *5	0.1% (0.01Ω, 1) *5	9999	146		
96	Auto tuning setting/status	0, 1, 11, 21	1	0	146, 180		
—	117	Parameter for manufacturer setting. Do not set.					
—	118						
—	119						
—	120						
—	121						
—	122						
—	123						
—	124						
—	⊙125	Frequency setting gain	0 to 400Hz	0.01Hz	60Hz	203	
—	126	Parameter for manufacturer setting. Do not set.					
PID operation	127	PID control automatic switchover frequency	0 to 400Hz, 9999	0.01Hz	9999	203	
	128	PID action selection	0, 20, 21, 40 to 43, 50, 51, 60, 61	1	0	203	
	129	PID proportional band	0.1 to 1000%, 9999	0.1%	100%	203	
	130	PID integral time	0.1 to 3600s, 9999	0.1s	1s	203	
	131	PID upper limit	0 to 100%, 9999	0.1%	9999	203	
	132	PID lower limit	0 to 100%, 9999	0.1%	9999	203	
	—	133	Parameter for manufacturer setting. Do not set.				
—	134	PID differential time	0.01 to 10.00s, 9999	0.01s	9999	203	
—	145	Parameter for manufacturer setting. Do not set.					
—	146						
—	147	Acceleration/deceleration time switching frequency	0 to 400Hz, 9999	0.01Hz	9999	135	
Current detection	150	Output current detection level	0 to 200%	0.1%	150%	172	
	151	Output current detection signal delay time	0 to 10s	0.1s	0s	172	
	152	Zero current detection level	0 to 200%	0.1%	5%	172	
	153	Zero current detection time	0 to 1s	0.01s	0.5s	172	

Parameter	Instruction Code			Control Mode-based Correspondence			Parameter	
	Read	Write	Extended	V/F	AD MFVC	GP MFVC	Clear	All clear
77	4D	— *9	0	○	○	○	○	○
78	4E	CE	0	○	○	○	○	○
⊙ 79	4F	— *9	0	○	○	○	○	○
80	50	D0	0	×	○	○	○	○
81	51	D1	0	×	○	○	○	○
82	52	D2	0	×	○	○	×	○
83	53	D3	0	×	○	○	○	○
84	54	D4	0	×	○	○	○	○
89	59	D9	0	×	○	×	×	○
90	5A	DA	0	○	○	○	×	○
91	5B	DB	0	×	○	○	×	○
92	5C	DC	0	×	○	○	×	○
93	5D	DD	0	×	○	○	×	○
94	5E	DE	0	×	○	○	×	○
96	60	E0	0	○	○	○	×	○
117	Parameter for manufacturer setting. Do not set.							
118								
119								
120								
121								
122								
123								
124								
⊙ 125	19	99	1	○	○	○	×	○
126	Parameter for manufacturer setting. Do not set.							
127	1B	9B	1	○	○	○	○	○
128	1C	9C	1	○	○	○	○	○
129	1D	9D	1	○	○	○	○	○
130	1E	9E	1	○	○	○	○	○
131	1F	9F	1	○	○	○	○	○
132	20	A0	1	○	○	○	○	○
133	Parameter for manufacturer setting. Do not set.							
134	22	A2	1	○	○	○	○	○
145	Parameter for manufacturer setting. Do not set.							
146	Parameter for manufacturer setting. Do not set.							
147	2F	AF	1	○	○	○	○	○
150	32	B2	1	○	○	○	○	○
151	33	B3	1	○	○	○	○	○
152	34	B4	1	○	○	○	○	○
153	35	B5	1	○	○	○	○	○

Function	Parameter	Name	Setting Range	Minimum Setting Increments	Initial Value	Refer to Page	Customer Setting	
—	156	Stall prevention operation selection	0 to 31, 100, 101	1	0	120		
—	157	OL signal output timer	0 to 25s, 9999	0.1s	0s	120		
—	⊙ 160	User group read selection	0, 1, 9999	1	0	197		
—	161	Frequency setting/key lock operation selection	0, 1, 10, 11	1	0	224		
Automatic restart functions	162	Automatic restart after instantaneous power failure selection	0, 1, 10, 11	1	1	180		
	165	Stall prevention operation level for restart	0 to 200%	0.1%	150%	180		
—	168	Parameter for manufacturer setting. Do not set.						
—	169	Parameter for manufacturer setting. Do not set.						
Cumulative monitor clear	170	Watt-hour meter clear	0, 10, 9999	1	9999	176		
	171	Operation hour meter clear	0, 9999	1	9999	176		
User group	172	User group registered display/batch clear	9999, (0 to 16)	1	0	197		
	173	User group registration	0 to 999, 9999	1	9999	197		
	174	User group clear	0 to 999, 9999	1	9999	197		
—	178	Parameter for manufacturer setting. Do not set.						
—	179	Parameter for manufacturer setting. Do not set.						
Input terminal function assignment	180	RY4 function selection	0 to 5, 7, 8, 10, 12, 14 to 16, 18, 24, 25, 62, 65 to 67, 9999	1	0	163		
	181	RY3 function selection		1	1	163		
	182	RY2 function selection		1	2	163		
	183	RY9 function selection		1	24	163		
	184	RYB function selection		1	62	163		
Output terminal function assignment	190	RX2 (terminal Y0) function selection	0, 1, 3, 4, 7, 8, 11 to 16, 20, 25, 26, 46, 47, 64, 68, 80, 81, 90, 91, 93, 95, 96, 98, 99, 100, 101, 103, 104, 107, 108, 111 to 116, 120, 125, 126, 146, 147, 164, 168, 180, 181, 190, 191, 193, 195, 196, 198, 199, 9999	1	0	167		
	191	RX6 function selection	0, 1, 3, 4, 7, 8, 11 to 16, 20, 25, 26, 46, 47, 64, 68, 80, 81, 90, 91, 95, 96, 98, 99, 100, 101, 103, 104, 107, 108, 111 to 116, 120, 125, 126, 146, 147, 164, 168, 180, 181, 190, 191, 195, 196, 198, 199, 9999	1	4	167		
	192	RX7 function selection	0, 1, 3, 4, 7, 8, 11 to 16, 20, 25, 26, 46, 47, 64, 68, 80, 81, 90, 91, 95, 96, 98, 99, 100, 101, 103, 104, 107, 108, 111 to 116, 120, 125, 126, 146, 147, 164, 168, 180, 181, 190, 191, 195, 196, 198, 199, 9999	1	99	167		
Multi-speed setting	232	Multi-speed setting (speed 8)	0 to 400Hz, 9999	0.01Hz	9999	130		
	233	Multi-speed setting (speed 9)	0 to 400Hz, 9999	0.01Hz	9999	130		
	234	Multi-speed setting (speed 10)	0 to 400Hz, 9999	0.01Hz	9999	130		
	235	Multi-speed setting (speed 11)	0 to 400Hz, 9999	0.01Hz	9999	130		
	236	Multi-speed setting (speed 12)	0 to 400Hz, 9999	0.01Hz	9999	130		
	237	Multi-speed setting (speed 13)	0 to 400Hz, 9999	0.01Hz	9999	130		
	238	Multi-speed setting (speed 14)	0 to 400Hz, 9999	0.01Hz	9999	130		
	239	Multi-speed setting (speed 15)	0 to 400Hz, 9999	0.01Hz	9999	130		
—	240	Soft-PWM operation selection	0, 1	1	1	192		
—	241	Parameter for manufacturer setting. Do not set.						

Parameter	Instruction Code			Control Mode-based Correspondence			Parameter	
	Read	Write	Extended	V/F	AD MFVC	GP MFVC	Clear	All clear
156	38	B8	1	○	○	○	○	○
157	39	B9	1	○	○	○	○	○
⊙ 160	00	80	2	○	○	○	○	○
161	01	81	2	○	○	○	×	○
162	02	82	2	○	○	○	○	○
165	05	85	2	○	○	○	○	○
168	Parameter for manufacturer setting. Do not set.							
169	Parameter for manufacturer setting. Do not set.							
170	0A	8A	2	○	○	○	×	○
171	0B	8B	2	○	○	○	×	×
172	0C	8C	2	○	○	○	×	×
173	0D	8D	2	○	○	○	×	×
174	0E	8E	2	○	○	○	×	×
178	Parameter for manufacturer setting. Do not set.							
179	Parameter for manufacturer setting. Do not set.							
180	14	94	2	○	○	○	×	○
181	15	95	2	○	○	○	×	○
182	16	96	2	○	○	○	×	○
183	17	97	2	○	○	○	×	○
184	18	98	2	○	○	○	×	○
190	1E	9E	2	○	○	○	×	○
191	1F	9F	2	○	○	○	×	○
192	20	A0	2	○	○	○	×	○
232	28	A8	2	○	○	○	○	○
233	29	A9	2	○	○	○	○	○
234	2A	AA	2	○	○	○	○	○
235	2B	AB	2	○	○	○	○	○
236	2C	AC	2	○	○	○	○	○
237	2D	AD	2	○	○	○	○	○
238	2E	AE	2	○	○	○	○	○
239	2F	AF	2	○	○	○	○	○
240	30	B0	2	○	○	○	○	○
241	Parameter for manufacturer setting. Do not set.							

Function	Parameter	Name	Setting Range	Minimum Setting Increments	Initial Value	Refer to Page	Customer Setting	
—	244	Cooling fan operation selection	0, 1	1	1	213		
Slip compensation	245	Rated slip	0 to 50%, 9999	0.01%	9999	119		
	246	Slip compensation time constant	0.01 to 10s	0.01s	0.5s	119		
	247	Constant-power range slip compensation selection	0, 9999	1	9999	119		
	—	249	Earth (ground) fault detection at start	0, 1	1	0	190	
—	250	Stop selection	0 to 100s, 1000 to 1100s, 8888, 9999	0.1s	9999	157		
—	251	Output phase loss protection selection	0, 1	1	1	190		
Life diagnosis	255	Life alarm status display	(0 to 15)	1	0	214		
	256	Inrush current limit circuit life display	(0 to 100%)	1%	100%	214		
	257	Control circuit capacitor life display	(0 to 100%)	1%	100%	214		
	258	Main circuit capacitor life display	(0 to 100%)	1%	100%	214		
	259	Main circuit capacitor life measuring	0, 1 (2, 3, 8, 9)	1	0	214		
Power failure stop	261	Power failure stop selection	0, 1, 2	1	0	186		
—	267	Parameter for manufacturer setting. Do not set.						
—	268	Monitor decimal digits selection	0, 1, 9999	1	9999	176		
—	269	Parameter for manufacturer setting. Do not set.						
—	270	Stop-on contact control selection	0, 1	1	0	158		
Stop-on contact control	275	Stop-on contact excitation current low-speed multiplying factor	0 to 300%, 9999	0.1%	9999	158		
	276	PWM carrier frequency at stop-on contact	0 to 9, 9999	1	9999	158		
—	277	Stall prevention operation current switchover	0, 1	1	0	120		
Brake sequence function	278	Brake opening frequency	0 to 30Hz	0.01Hz	3Hz	160		
	279	Brake opening current	0 to 200%	0.1%	130%	160		
	280	Brake opening current detection time	0 to 2s	0.1s	0.3s	160		
	281	Brake operation time at start	0 to 5s	0.1s	0.3s	160		
	282	Brake operation frequency	0 to 30Hz	0.01Hz	6Hz	160		
	283	Brake operation time at stop	0 to 5s	0.1s	0.3s	160		
Droop control	286	Droop gain	0 to 100%	0.1%	0%	210		
	287	Droop filter time constant	0 to 1s	0.01s	0.3s	210		
—	292	Automatic acceleration/deceleration	0, 1, 7, 8, 11	1	0	140		
—	293	Acceleration/deceleration separate selection	0 to 2	1	0	140		
—	295	Magnitude of frequency change setting	0, 0.01, 0.1, 1, 10	0.01	0	226		
Password function	296	Password lock level	0 to 6, 99, 100 to 106, 199, 9999	1	9999	199		
	297	Password lock/unlock	(0 to 5), 1000 to 9998, 9999	1	9999	199		
—	298	Frequency search gain	0 to 32767, 9999	1	9999	180		
—	299	Rotation direction detection selection at restarting	0, 1, 9999	1	0	180		
Digital output	⊙ 313	RX9 function selection	0, 1, 3, 4, 7, 8, 11 to 16, 20, 25, 26, 46, 47, 64, 68, 80, 81, 90, 91, 93, 95, 96, 98, 99, 100, 101, 103, 104, 107, 108, 111 to 116, 120, 125, 126, 146, 147, 164, 168, 180, 181, 190, 191, 193, 195, 196, 198, 199, 9999	1	9999	167		
	⊙ 314	RXA function selection		1	9999	167		
	⊙ 315	RXB function selection		1	9999	167		

Parameter	Instruction Code			Control Mode-based Correspondence			Parameter	
	Read	Write	Extended	V/F	AD MFVC	GP MFVC	Clear	All clear
244	34	B4	2	○	○	○	○	○
245	35	B5	2	○	×	○	○	○
246	36	B6	2	○	×	○	○	○
247	37	B7	2	○	×	○	○	○
249	39	B9	2	○	○	○	○	○
250	3A	BA	2	○	○	○	○	○
251	3B	BB	2	○	○	○	○	○
255	3F	BF	2	○	○	○	×	×
256	40	C0	2	○	○	○	×	×
257	41	C1	2	○	○	○	×	×
258	42	C2	2	○	○	○	×	×
259	43	C3	2	○	○	○	○	○
261	45	C5	2	○	○	○	○	○
267	Parameter for manufacturer setting. Do not set.							
268	4C	CC	2	○	○	○	○	○
269	Parameter for manufacturer setting. Do not set.							
270	4E	CE	2	×	○	○	○	○
275	53	D3	2	×	○	○	○	○
276	54	D4	2	×	○	○	○	○
277	55	D5	2	○	○	○	○	○
278	56	D6	2	×	○	○	○	○
279	57	D7	2	×	○	○	○	○
280	58	D8	2	×	○	○	○	○
281	59	D9	2	×	○	○	○	○
282	5A	DA	2	×	○	○	○	○
283	5B	DB	2	×	○	○	○	○
286	5E	DE	2	×	○	×	○	○
287	5F	DF	2	×	○	×	○	○
292	64	E4	2	○	○	○	○	○
293	65	E5	2	○	○	○	○	○
295	67	E7	2	○	○	○	○	○
296	68	E8	2	○	○	○	×	○
297	69	E9	2	○	○	○	×*8	○
298	6A	EA	2	○	○	○	×	○
299	6B	EB	2	○	○	○	○	○
⊙ 313	0D	8D	3	○	○	○	○	○
⊙ 314	0E	8E	3	○	○	○	○	○
⊙ 315	0F	8F	3	○	○	○	○	○

Function	Parameter	Name	Setting Range	Minimum Setting Increments	Initial Value	Refer to Page	Customer Setting
—	338	Parameter for manufacturer setting. Do not set.					
—	339	Parameter for manufacturer setting. Do not set.					
—	340	Parameter for manufacturer setting. Do not set.					
—	342	Communication EEPROM write selection	0, 1	1	0	110	
—	343	Parameter for manufacturer setting. Do not set.					
—	⊙ 349	Communication reset selection	0, 1	1	0	110	
Second motor constant	450	Second applied motor	0, 1, 9999	1	9999	144	
Output	495	Remote output selection	0, 1, 10, 11	1	0	174	
	496	Remote output data 1	0 to 4095	1	0	174	
—	497	Parameter for manufacturer setting. Do not set.					
Communication error	⊙ 500	Communication error execution waiting time	0 to 999.8s	0.1s	0	107	
	⊙ 501	Communication error occurrence count display	0	1	0	107	
	502	Stop mode selection at communication error	0, 1, 2, 3	1	0	107	
Maintenance	503	Maintenance timer	0 (1 to 9998)	1	0	217	
	504	Maintenance timer alarm output set time	0 to 9998, 9999	1	9999	217	
CC-Link	⊙ 541	Frequency command sign selection (CC-Link)	0, 1	1	0	105	
	⊙ 542	Communication station number (CC-Link)	1 to 64	1	1	105	
	⊙ 543	Baud rate selection (CC-Link)	0 to 4	1	0	105	
	⊙ 544	CC-Link extended setting	0, 1, 12, 14, 18	1	0	105	
USB	547	USB communication station number	0 to 31	1	0	220	
	548	USB communication check time interval	0 to 999.8s, 9999	0.1s	9999	220	
—	549	Parameter for manufacturer setting. Do not set.					
—	550	Parameter for manufacturer setting. Do not set.					
—	551	PU mode operation command source selection	2 to 4, 9999	1	9999	220	
Current average time monitor	555	Current average time	0.1 to 1.0s	0.1s	1s	218	
	556	Data output mask time	0 to 20s	0.1s	0s	218	
	557	Current average value monitor signal output reference current	0 to 500A	0.01A	Rated inverter current	218	

Parameter	Instruction Code			Control Mode-based Correspondence			Parameter	
	Read	Write	Extended	V/F	AD MFVC	GP MFVC	Clear	All clear
338	Parameter for manufacturer setting. Do not set.							
339	Parameter for manufacturer setting. Do not set.							
340	Parameter for manufacturer setting. Do not set.							
342	2A	AA	3	○	○	○	○	○
343	Parameter for manufacturer setting. Do not set.							
⊙ 349	31	B1	3	○	○	○	○+7	○+7
450	32	B2	4	○	○	○	○	○
495	5F	DF	4	○	○	○	○	○
496	60	E0	4	○	○	○	×	×
497	Parameter for manufacturer setting. Do not set.							
⊙ 500	00	80	5	○	○	○	○	○
⊙ 501	01	81	5	○	○	○	○	○
502	02	82	5	○	○	○	○	○
503	03	83	5	○	○	○	×	×
504	04	84	5	○	○	○	×	○
⊙ 541	29	A9	5	○	○	○	○+7	○+7
⊙ 542	2A	AA	5	○	○	○	○+7	○+7
⊙ 543	2B	AB	5	○	○	○	○+7	○+7
⊙ 544	2C	AC	5	○	○	○	○+7	○+7
547	2F	AF	5	○	○	○	○+7	○+7
548	30	B0	5	○	○	○	○+7	○+7
549	Parameter for manufacturer setting. Do not set.							
550	Parameter for manufacturer setting. Do not set.							
551	33	B3	5	○	○	○	○+7	○+7
555	37	B7	5	○	○	○	○	○
556	38	B8	5	○	○	○	○	○
557	39	B9	5	○	○	○	○	○

Function	Parameter	Name	Setting Range	Minimum Setting Increments	Initial Value	Refer to Page	Customer Setting
—	563	Energization time carrying-over times	(0 to 65535)	1	0	176	
—	564	Operating time carrying-over times	(0 to 65535)	1	0	176	
—	571	Holding time at a start	0 to 10s, 9999	0.1s	9999	138	
—	611	Acceleration time at a restart	0 to 3600s, 9999	0.1s	9999	180	
—	653	Speed smoothing control	0 to 200%	0.1%	0	193	
—	665	Regeneration avoidance frequency gain	0 to 200%	0.1%	100	211	
—	800	Control method selection	20, 30	1	20	112, 114, 117	
—	859	Torque current	0 to 500A (0 to ****) , 9999 *5	0.01A (1) *5	9999	146	
Protective functions	872 *6	Input phase loss protection selection	0, 1	1	1	190	
	882	Regeneration avoidance operation selection	0, 1, 2	1	0	211	
Regeneration avoidance function	883	Regeneration avoidance operation level	300 to 800V	0.1V	400VDC/780VDC *4	211	
	885	Regeneration avoidance compensation frequency limit value	0 to 10Hz, 9999	0.01Hz	6Hz	211	
	886	Regeneration avoidance voltage gain	0 to 200%	0.1%	100%	211	
Free parameter	888	Free parameter 1	0 to 9999	1	9999	222	
	889	Free parameter 2	0 to 9999	1	9999	222	
—	C0	Parameter for manufacturer setting. Do not set.					
—	C2	Frequency setting bias	0 to 400Hz	0.01Hz	0Hz	203	
—	C3	Parameter for manufacturer setting. Do not set.					
—	C4						
—	C5						
—	C6						
—	C7						
—	C22						
—	C23						
—	C24						
—	C25						
—	990						
—	991						

Parameter	Instruction Code			Control Mode-based Correspondence			Parameter	
	Read	Write	Extended	V/F	AD MFVC	GP MFVC	Clear	All clear
563	3F	BF	5	○	○	○	×	×
564	40	C0	5	○	○	○	×	×
571	47	C7	5	○	○	○	○	○
611	0B	8B	6	○	○	○	○	○
653	35	B5	6	○	○	○	○	○
665	41	C1	6	○	○	○	○	○
800	00	80	8	×	○	○	○	○
859	3B	BB	8	×	○	○	×	○
872	48	C8	8	○	○	○	○	○
882	52	D2	8	○	○	○	○	○
883	53	D3	8	○	○	○	○	○
885	55	D5	8	○	○	○	○	○
886	56	D6	8	○	○	○	○	○
888	58	D8	8	○	○	○	×	×
889	59	D9	8	○	○	○	×	×
C0	Parameter for manufacturer setting. Do not set.							
C2	5E	DE	1	○	○	○	×	○
C3	Parameter for manufacturer setting. Do not set.							
C4								
C5								
C6								
C7								
C22								
C23								
C24								
C25								
990								
991								

Function	Parameter	Name	Setting Range	Minimum Setting Increments	Initial Value	Refer to Page	Customer Setting
Clear parameters Initial value change list	Pr.CL	Parameter clear	0, 1	1	0	227	
	ALLC	All parameter clear	0, 1	1	0	227	
	Er.CL	Faults history clear	0, 1	1	0	229	
	Pr.CH	Initial value change list	—	—	—	228	

- *1 Differ according to capacities.
6%: 0.75K or lower
4%: 1.5K to 3.7K
3%: 5.5K, 7.5K
2%: 11K, 15K
- *2 Differ according to capacities.
5s: 3.7K or lower
10s: 5.5K, 7.5K
15s: 11K, 15K
- *3 Differ according to capacities.
6%: 0.1K, 0.2K
4%: 0.4K to 7.5K
2%: 11K, 15K
- *4 The initial value differs according to the voltage class. (200V class/400V class)
- *5 The range differs according to the Pr. 71 setting.
- *6 Available only for the three-phase power input model.
- *7 These parameters are communication parameters that are not cleared when parameter clear (all clear) is executed from CC-Link communication. (Refer to page 64 for parameter clear (all parameter clear) from CC-Link communication).
- *8 If a password has been registered (Pr.297 ≠ "9999"), the parameter setting can be cleared (the password lock can be unlocked) only via CC-Link communication.
- *9 Settings cannot be written during CC-Link communication (under Network operation mode).

Parameter	Instruction Code			Control Mode-based Correspondence			Parameter	
	Read	Write	Extended	V/F	AD MFVC	GP MFVC	Clear	All clear
Pr.CL	—	FC	—	—	—	—	—	—
ALLC	—	FC	—	—	—	—	—	—
Er.CL	—	F4	—	—	—	—	—	—
Pr.CH	—	—	—	—	—	—	—	—

5.3	Selection of operation mode	103
5.3.1	Operation mode selection (Pr. 79).....	103
5.4	Operation via CC-Link communication and its settings	105
5.4.1	CC-Link communication setting (Pr.541 to Pr.544)	105
5.4.2	Operation selection at CC-Link communication error occurrence (Pr. 500 to Pr. 502).....	107
5.4.3	CC-Link communication reset selection (Pr.349)	110
5.4.4	Communication EEPROM write selection (Pr. 342)	110
5.5	Control mode	111
5.5.1	Changing the control method (Pr. 80, Pr. 81, Pr. 800)	112
5.6	Adjustment of the output torque (current) of the motor	113
5.6.1	Manual torque boost (Pr. 0, Pr. 46)	113
5.6.2	Advanced magnetic flux vector control (Pr. 71, Pr. 80, Pr. 81, Pr.89, Pr. 800)	114
5.6.3	General-purpose magnetic flux vector control (Pr. 71, Pr. 80, Pr. 81, Pr. 800)	117
5.6.4	Slip compensation (Pr. 245 to Pr. 247)	119
5.6.5	Stall prevention operation (Pr. 22, Pr. 23, Pr. 48, Pr. 66, Pr. 156, Pr. 157, Pr. 277)	120
5.7	Limiting the output frequency	124
5.7.1	Maximum/minimum frequency (Pr. 1, Pr. 2, Pr. 18).....	124
5.7.2	Avoiding mechanical resonance points (frequency jumps) (Pr. 31 to Pr. 36).....	125
5.8	V/F pattern	126
5.8.1	Base frequency, voltage (Pr. 3, Pr. 19, Pr. 47).....	126
5.8.2	Load pattern selection (Pr. 14)	128
5.9	Frequency setting with input signals	130
5.9.1	Operation by multi-speed operation (Pr. 4 to Pr. 6, Pr. 24 to Pr. 27, Pr. 232 to Pr. 239).....	130
5.9.2	Remote setting function (Pr. 59).....	132
5.10	Setting of acceleration/deceleration time and acceleration/ deceleration pattern	135
5.10.1	Setting of the acceleration and deceleration time (Pr. 7, Pr. 8, Pr. 20, Pr. 21, Pr. 44, Pr. 45, Pr. 147)	135
5.10.2	Starting frequency and start-time hold function (Pr. 13, Pr. 571).....	138
5.10.3	Acceleration/deceleration pattern (Pr. 29)	139
5.10.4	Shortest acceleration/deceleration (automatic acceleration/deceleration) (Pr. 61 to Pr. 63, Pr. 292, Pr. 293).....	140
5.11	Selection and protection of a motor	142
5.11.1	Motor overheat protection (Electronic thermal O/L relay) (Pr. 9, Pr. 51)	142
5.11.2	Applied motor (Pr. 71, Pr. 450).....	144
5.11.3	Exhibiting the best performance for the motor (offline auto tuning) (Pr. 71, Pr. 80 to Pr. 84, Pr. 90 to Pr. 94, Pr. 96, Pr. 859)	146
5.12	Motor brake and stop operation	154
5.12.1	DC injection brake (Pr. 10 to Pr. 12).....	154
5.12.2	Selection of a regenerative brake (Pr. 30, Pr. 70)	155

5.12.3	Stop selection (Pr. 250)	157
5.12.4	Stop-on contact control function (Pr. 6, Pr. 48, Pr. 270, Pr. 275, Pr. 276)	158
5.12.5	Brake sequence function (Pr. 278 to Pr. 283, Pr. 292).....	160
5.13 Function assignment of external terminals and CC-Link communication virtual terminals		163
5.13.1	Input terminal function selection (Pr. 180 to Pr. 184)	163
5.13.2	Inverter output shutoff signal (MRS signal, Pr. 17).....	166
5.13.3	Output terminal function selection (Pr. 190 to Pr. 192, Pr. 313 to Pr. 315)	167
5.13.4	Detection of output frequency (SU, FU signal, Pr. 41 to Pr. 43).....	171
5.13.5	Output current detection function (Y12 signal, Y13 signal, Pr. 150 to Pr. 153)	172
5.13.6	Remote output selection (REM signal, Pr. 495, Pr. 496).....	174
5.14 Monitor display and monitor output signal		175
5.14.1	Speed display and speed setting (Pr. 37).....	175
5.14.2	Monitor display selection of operation panel (Pr. 52, Pr. 170, Pr. 171, Pr. 268, Pr. 563, Pr. 564).....	176
5.15 Operation selection at power failure and instantaneous power failure		180
5.15.1	Automatic restart after instantaneous power failure/flying start (Pr. 57, Pr. 58, Pr. 96, Pr. 162, Pr. 165, Pr. 298, Pr. 299, Pr. 611)	180
5.15.2	Power-failure deceleration stop function (Pr. 261)	186
5.16 Operation setting at fault occurrence		188
5.16.1	Retry function (Pr. 65, Pr. 67 to Pr. 69)	188
5.16.2	Input/output phase loss protection selection (Pr. 251, Pr. 872).....	190
5.16.3	Earth (ground) fault detection at start (Pr. 249).....	190
5.17 Energy saving operation		191
5.17.1	Optimum excitation control (Pr. 60).....	191
5.18 Motor noise, EMI measures, mechanical resonance		192
5.18.1	PWM carrier frequency and soft-PWM control (Pr. 72, Pr. 240).....	192
5.18.2	Speed smoothing control (Pr. 653).....	193
5.19 Misoperation prevention and parameter setting restriction		194
5.19.1	Reset selection/PU stop selection (Pr. 75)	194
5.19.2	Parameter write disable selection (Pr. 77).....	196
5.19.3	Reverse rotation prevention selection (Pr. 78)	197
5.19.4	Extended parameter display and user group function (Pr. 160, Pr. 172 to Pr. 174).....	197
5.19.5	Password function (Pr. 296, Pr. 297).....	199
5.20 Special operation and frequency control		201
5.20.1	JOG operation (Pr. 15, Pr. 16).....	201
5.20.2	PID control (Pr. 125, Pr. 127 to Pr. 132, Pr. 134, C2)	203
5.20.3	Droop control (Pr. 286, Pr. 287)	210
5.20.4	Regeneration avoidance function (Pr. 665, Pr. 882, Pr. 883, Pr. 885, Pr. 886).....	211
5.21 Useful functions		213

5.21.1	Cooling fan operation selection (Pr. 244)	213
5.21.2	Display of the life of the inverter parts (Pr. 255 to Pr. 259).....	214
5.21.3	Maintenance timer alarm (Pr. 503, Pr. 504).....	217
5.21.4	Average current monitor signal (Pr. 555 to Pr. 557)	218
5.21.5	USB communication (Pr. 547, Pr. 548, Pr. 551)	220
5.21.6	Free parameter (Pr. 888, Pr. 889)	222
5.22 Setting from the operation panel		223
<hr/>		
5.22.1	RUN key rotation direction selection (Pr. 40).....	223
5.22.2	Operation panel frequency setting/key lock operation selection (Pr. 161).....	224
5.22.3	Magnitude of frequency change setting (Pr. 295).....	226
5.23 Parameter clear/ All parameter clear		227
<hr/>		
5.24 Initial value change list		228
<hr/>		
5.25 Check and clear of the faults history		229
<hr/>		







5.3 Selection of operation mode

5.3.1 Operation mode selection (Pr. 79)

Select the operation mode of the inverter.

The operation mode can be selected between the CC-Link communication operation (Network operation) and the operation panel operation (PU operation). At power-ON or power restoration after instantaneous power failure, the inverter always starts in the Network operation mode.

After the inverter starts up in Network operation mode, parameter writing and operation can be commanded from programs.

Parameter Number	Name	Initial Value	Setting Range	Description	LED Indication :Off :On
79	Operation mode selection	0	0	Using  on the operation panel, you can switch the operation mode between NET and PU. At power ON, the inverter is in the NET operation mode.	NET operation mode  PU operation mode 
			1	Fixed to PU operation mode	PU operation mode 
			2	Fixed to Network operation mode	NET operation mode 
			3,4	For manufacturer setting. Do not set.	
			6	Switchover mode Switchover between PU operation and NET operation is available while keeping the same operation status.	PU operation mode  NET operation mode 
			7	For manufacturer setting. Do not set.	

The above parameter can be changed during a stop in any operation mode. It cannot be set via CC-Link communication.

(1) Operation mode basics

- The operation mode specifies the source of the start command and the frequency command for the inverter.
- Basically, there are following operation modes.
 - Network operation mode (NET operation mode): Start and frequency commands are input via CC-Link communication
 - PU operation mode: Start operation and frequency commands are input with the operation panel.
- Use  on the operation panel or the instruction code of CC-Link communication to switch between the operation modes.

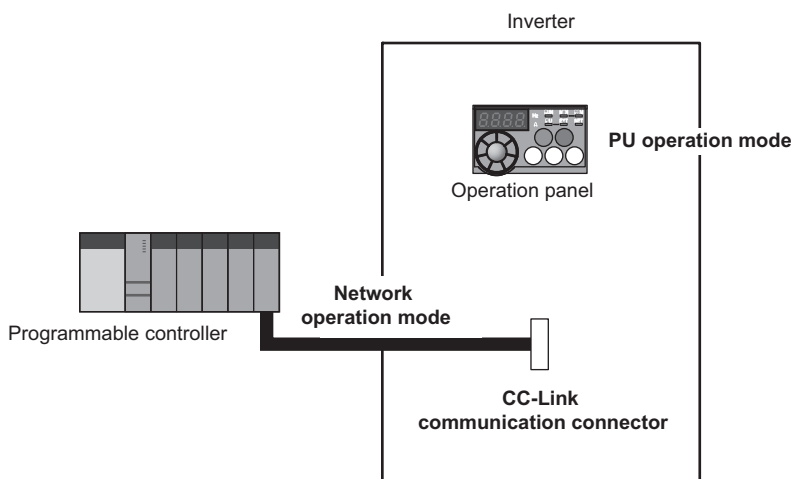

REMARKS

- The stop function (PU stop selection) activated by pressing  of the operation panel is valid even in other than the PU operation mode in the initial setting. (Refer to Pr. 75 Reset selection/PU stop selection (page 194))

(2) Network operation mode (Pr. 79 setting "0" (initial value), "2")

- Select the Network operation mode to give start and frequency commands via CC-Link communication.
- Generally, parameter change cannot be performed from the operation panel in the Network operation mode. (Some parameters can be changed. Refer to the detailed description of each parameter.)
- When "0" (initial value) is selected for Pr. 79, the inverter enters the Network operation mode at power-ON.
- When frequent parameter changing is necessary, setting "0" (initial value) allows the operation mode to be changed easily to the PU operation mode by pressing  of the operation panel. When you switched to the PU operation mode, always return to the Network operation mode.
- Pr. 79 = "2" sets the Network operation mode to be always selected at power-ON and disables the operation mode change.

(3) PU operation mode (Pr. 79 setting "1")



- Select the PU operation mode when applying start and frequency command by only the key operation of the operation panel. Also select the PU operation mode when making communication using the PU connector.
- When "1" is selected for Pr. 79, the inverter enters the PU operation mode at power ON. You cannot change to the other operation mode.
- The setting dial of the operation panel can be used for setting like a potentiometer. (Refer to Pr. 161 Frequency setting/key lock operation selection (page 224))

(4) Switch-over mode (Pr. 79 setting "6")

- While continuing operation, you can switch between the PU operation and the Network operation (CC-Link communication).

Operation Mode Switching	Switching Operation/Operating Status
PU operation → NET operation	Send the mode change command to the Network operation mode through CC-Link communication. (Rotation direction and set frequency are the same as those of PU operation.)
NET operation → PU operation	Select the PU operation mode with the operation panel. (The rotation direction and frequency command in the Network operation mode are used unchanged.)

(5) Valid command in each operation mode

- The following table lists valid and invalid commands in each operation mode. Monitoring and parameter reading are valid in any operation mode.

Command source	Operation mode		
	Item	PU operation	NET operation
Operation panel	Operation (start) command	○	×
	Operation (stop) command	○	△ *3
	Running frequency	○	×
	Parameter writing	○ *1	×
	Inverter reset	○	×
CC-Link communication	Operation (start) command	×	○
	Operation (stop) command	×	○
	Running frequency	×	○
	Parameter writing	×	○ *1
	Inverter reset	×	○

○: Valid ×: Invalid △: Partially valid

- *1 Writing of some parameters may be disabled by the Pr.77 Parameter write selection setting and the operating condition. (Refer to page 196)
- *2 Writing of some parameters is enabled regardless of the operation mode and the command source. Writing is also enabled when Pr.77 = "2." (Refer to the parameter list on page 84.) Parameters cannot be cleared.
- *3 Only the PU stop is enabled. PS is displayed on the operation panel during PU stop. The inverter operates according to the Pr.75 Reset selection/PU stop selection setting. (Refer to page 194.)



Parameters referred to

Pr. 75 Reset selection/PU stop selection  Refer to page 194

Pr. 77 Parameter write selection  Refer to page 196

Pr. 161 Frequency setting/key lock operation selection  Refer to page 224

5.4 Operation via CC-Link communication and its settings

Purpose	Parameter that should be Set	Refer to Page
To make CC-Link communication settings	Communication station number setting Baud rate setting Frequency command sign selection Extended CC-Link setting	Pr.541 to Pr.544 105
To select the operation at CC-Link communication error occurrence	Communication error execution waiting time Communication error occurrence count display Stop method at communication error	Pr.500 to Pr.502 107
To select the error reset operation at inverter failure	Communication reset selection	Pr.349 110
To limit parameter writing via CC-Link communication	Communication EEPROM write selection	Pr.342 110

5.4.1 CC-Link communication setting (Pr.541 to Pr.544)

Set the CC-Link communication details such as station number and baud rate.

Parameter Number	Name	Initial Value	Setting Range	Description	
541	Frequency command sign selection (CC-Link)	0	0	Without sign A plus/minus sign added to the frequency command inverts the forward and reverse start commands.	
			1	With sign Make selection of sign for the frequency command from RWw1.	
542	Communication station number (CC-Link)	1	1 to 64	Sets the station number.	
543	Baud rate selection (CC-Link)	0	0	156kbps	Sets the transmission speed.
			1	625kbps	
			2	2.5Mbps	
			3	5Mbps	
			4	10Mbps	
544	CC-Link extended setting	0	0, 1, 12, 14, 18	Extends the remote register function.	

(1) Station number setting (Pr. 542)

- Use Pr. 542 Communication station number (CC-Link) to set station number of the inverter. Set this parameter within the range of 1 to 64.



NOTE

- Use different station numbers for different devices. (If different devices have the same station number, the communication cannot be performed properly.)

Connection example

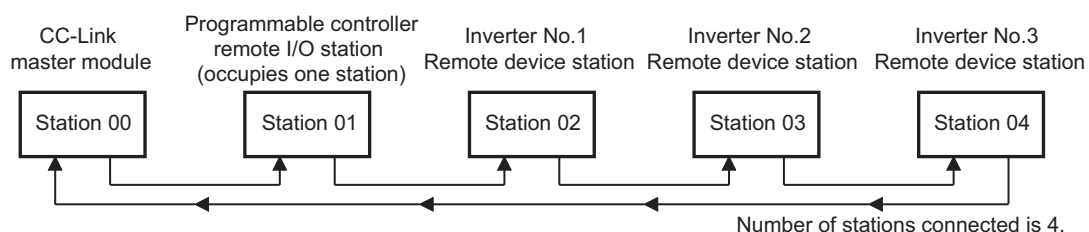

REMARKS

- Set consecutive numbers for the station numbers. (Do not skip a number in sequence like "station number 1 - station number 2 - station number 4".)
- The station number does not have to match with the physical connection sequence. (There is no problem with having the physical connection sequence like "station number 1 - station number 3 - station number 4 - station number 2".)
- One inverter occupies one station. (One remote device station)
- "L.ERR" LED flickers if the setting is changed. When power is switched ON again, the setting value is applied and the LED turns OFF.

(2) Baud rate setting (Pr. 543)

- Set the transmission speed. (Refer to the manual of the CC-Link master module for details of transmission speed.)

REMARKS

- "L.ERR" LED flickers when a setting is changed. Power OFF-ON the inverter (inverter reset) to apply the setting and to turn OFF the LED.

(3) Frequency command with sign (Pr. 541)

- By frequency command with sign, start command (forward rotation/reverse rotation) can be inversed to operate. Make selection of sign for the frequency command from RWw1.

Pr.541 Setting	Sign	Setting Range	Actual Frequency Command
0	Not used	0 to 40000	0 to 400.00Hz
1	With	-32768 to 32767 (two's complement)	-327.68 to 327.67Hz

Relationship between the start command and sign (Pr.541 = "1")

Start Command	Sign of the Frequency Command	Actual Run Command
Forward rotation	+	Forward rotation
	-	Reverse rotation
Reverse rotation	+	Reverse rotation
	-	Forward rotation

REMARKS

- When Pr.541 = 1 (with sign)
 - When EEPROM write is specified with the RYE, write mode error (error code H01) will occur.
 - When concurrent execution of both RYD and RYE is enabled (when a value other than 0 is set in Pr.544) and both RYD and RYE are turned ON, RYD has precedence.
 - When power is turned ON (inverter reset), the initial setting status of the sign bit is "positive" and the set frequency is "0Hz". (EEPROM value is not reflected.)
The frequency saved in EEPROM becomes valid when the PU operation mode has been selected as the operation mode at power-ON (inverter reset) (Pr. 79 = "1").
 - When set frequency is written with the instruction code of HED and HEE, the sign of the frequency command is not changed.

(4) CC-Link extended setting (Pr. 544)

- Remote register function can be extended.

Pr.544 Setting	CC-Link Ver.	Description	Refer to page
0 (initial value)	1	Occupies one station (FR-E500 series compatible) *1	56
1		Occupies one station	57
12 *2	2	Occupies one station double	57
14 *2		Occupies one station quadruple	58
18 *2		Occupies one station octuple	59

*1 The program used for conventional series inverter (FR-E500 series) can be used.
When RYD, RYE, and RYF turn ON simultaneously, only one of them is executed.
The upper 8 bits of RWw2 are not link parameter extended setting.

*2 When using double, quadruple and octuple settings of the CC-Link Ver. 2, station data of the master station must be set to double, quadruple and octuple also. (If the master station is CC-Link Ver. 1 compatible station, the above setting cannot be made.)

REMARKS

- The setting change is reflected after an inverter reset. (Refer to page 110 for inverter reset.)

5.4.2 Operation selection at CC-Link communication error occurrence (Pr. 500 to Pr. 502)

The inverter operation after an error occurs in the CC-Link communication can be selected.

Parameter Number	Name	Initial Value	Setting Range	Description
500	Communication error execution waiting time	0	0 to 999.8s	Sets the waiting time from the communication error occurrence to the communication error activation.
501	Communication error occurrence count display	0	0	Displays the communication error occurrence count. Writing "0" in this parameter clears the cumulative count.
502*	Stop mode selection at communication error	0	0 to 3	Sets the inverter operation at a fault occurred in the communication line or in the CC-Link communication circuit in the inverter.

* The parameter can be set when Pr. 160 User group read selection = "0." (Refer to page 197)

(1) Waiting time for the communication line error output after a communication error (Pr.500)

- Waiting time for the communication error output after a communication line error occurrence can be set. When a communication line error occurs and lasts longer than the time set in Pr. 500, it is recognized as a communication error. If the communication returns to normal within the time, it is not recognized as a communication error, and the operation continues.

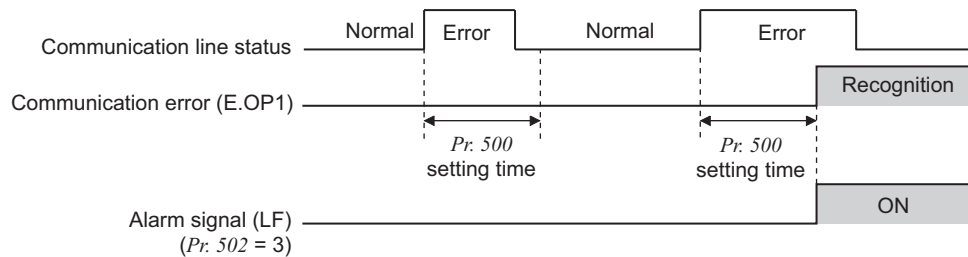

(2) Displaying and clearing the communication error count (Pr.501)

- The cumulative count of communication error occurrences can be displayed. Write "0" to clear this cumulative count. At the point of communication line error occurrence, Pr. 501 Communication error occurrence count display is incremented by 1.

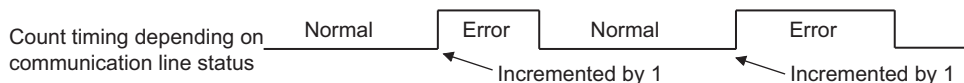

NOTE

- Communication error count is temporarily stored in the RAM. The error count is stored in EEPROM only once per hour. If power reset or inverter reset is performed, Pr. 501 setting will be the one that is last stored to EEPROM depending on the reset timing.

(3) Inverter operation at a communication error occurrence (Pr.502)

- The inverter operation after a fault occurs in the communication line or in the CC-Link communication circuit can be selected.
- About setting
- Operation at an error occurrence

Error Definition	Pr. 502 Setting	Operation	Indication	Fault Output
Communication line	0 (initial value)	Continued *	Normal indication *	Not provided *
	1			
	2			
	3			
CC-Link communication circuit in inverter	0 (initial value), 3	Coast to stop	E. 1 lit	Provided
	1, 2	Decelerated to stop	E. 1 lit after stop	Provided after stop

* When the communication returns to normal within the time period set in Pr. 500, the communication option error (E.OP1) does not occur.

- Operation at error recognition after elapse of Pr. 500 time

Error Definition	Pr. 502 Setting	Operation	Indication	Fault Output
Communication line	0 (initial value)	Coast to stop	E.OP1 lit	Provided
	1	Decelerated to stop	E.OP1 lit after stop	Provided after stop
	2			Not provided
	3	Continued	Normal indication	
CC-Link communication circuit in inverter	0 (initial value), 3	Coast to stop	E. 1 lit	Provided
	1, 2	Decelerated to stop	E. 1 lit after stop	Provided after stop

- Operation at error removal

Error Definition	Pr. 502 Setting	Operation	Indication	Fault Output
Communication line	0 (initial value)	Kept stopped	E.OP1 kept lit	Kept provided
	1			
	2	Restart	Normal indication	Not provided
	3	Continued		
CC-Link communication circuit in inverter	0 (initial value), 3	Kept stopped	E. 1 kept lit	Kept provided
	1, 2			



REMARKS

- The communication line error [E.OP1 (fault data HA1)] appears after an error occurrence on the CC-Link communication line.
- Fault output indicates the fault output signal (ALM signal) and fault bit output.
- When the fault output setting is active, fault records are stored in the faults history. (A fault record is written to the faults history at fault output.)
When the fault output setting is not active, fault record is overwritten to the faults history temporarily but not stored.
After the error is removed, the fault indication is reset, changing the display back to normal, and the last fault is displayed in the faults history.
- When the Pr. 502 setting is "1" or "2", the deceleration time is the normal deceleration time setting (e.g. Pr. 8, Pr. 44, Pr. 45).
- The acceleration time at a restart is the normal acceleration time setting (e.g. Pr. 7, Pr. 44).
- When the Pr. 502 setting is "2", the operation/speed command at a restart is the one given before the error occurrence.
- When a communication line error occurs at the Pr. 502 setting of "2", removing the error during deceleration causes acceleration to restart at that point. (Acceleration does not restart at a CC-Link communication line error of the inverter.)

(4) Faults and measures

•The following table shows how the inverter operates at a fault occurrence in each operation mode.

Fault Location	Fault Indication*	Status	Operation Mode	
			Network operation	PU operation
Communication line	E.OP1	Inverter operation	Inverter trip*	Continued
		Data communication	Stop	Stop
Inverter	Faults other than E.1 and E.OP1	Inverter operation	Inverter trip	Inverter trip
		Data operation	Continued	Continued
	E.1	Inverter operation	Inverter trip*	Continued
		Data communication	Stop	Stop

* Depends on the Pr.502 setting.

• Measures at fault occurrences

Fault Indication	Fault Definition	Measures
E.OP1	Communication line error	Check the LED status of the inverter and remove the cause of the fault. (Refer to page 75 for LED indication status) Inspect the master.
E.1	CC-Link communication circuit fault in inverter	Check for excessive noise around the inverter. Check that the switch for manufacturer setting has not been changed and is in the initial status. Remove the fault cause.

* When faults other than the above are displayed, refer to Appendix 6 and remove the cause of the error.



Parameters referred to

Pr. 7 Acceleration time, Pr. 8 Deceleration time, Pr. 44 Second acceleration/deceleration time, Pr. 45 Second deceleration time  Refer to page 135

5.4.3 CC-Link communication reset selection (Pr.349)

The RY1A error reset command (on page 60) transmitted via CC-Link communication in PU operation mode can be disabled.

Parameter Number	Name	Initial Value	Setting Range	Function
349	Communication reset selection	0	0	Error reset is enabled independently of operation mode
			1	Error reset is enabled only in the Network operation mode

(1) Operation conditions of inverter reset

- The following table shows the availability of the inverter reset in each operation mode.

Resetting Method			Operation Mode	
			Network Operation	PU Operation
Reset via CC-Link communication	Inverter reset (Refer to page 65) *1		Allowed	Disallowed
	Error reset (RY1A) at inverter fault (Refer to page 60) *2	Pr.349 = 0	Allowed	Allowed
		Pr.349 = 1	Allowed	Disallowed
Switch OFF inverter power			Allowed	Allowed
Reset from the operation panel (Reset at inverter fault) *2			Allowed	Allowed

*1 Inverter reset can be made any time.

*2 Reset can be made only when the protective function of the inverter is activated.



REMARKS

- Refer to page 73 for the programming example of an inverter reset.



NOTE

- When a communication line error has occurred, reset cannot be made from the network.
- Communication continues during inverter reset. (The inverter cannot be controlled for about 1s after release of a reset command.)

5.4.4 Communication EEPROM write selection (Pr. 342)

Storage device can be changed to RAM only from EEPROM+RAM for the parameter settings written through the CC-Link communication. Use this function if parameter settings are changed frequently.

Parameter Number	Name	Initial Value	Setting Range	Description
342	Communication EEPROM write selection	0	0	Parameter values written via CC-Link communication are written to the EEPROM and RAM.
			1	Parameter values written via CC-Link communication are written to the RAM.

The above parameters can be set when Pr. 160 User group read selection = "0." (Refer to page 197)

- When changing the parameter values frequently, set "1" in Pr. 342 to write them to the RAM.

Performing frequent parameter write with "0 (initial value)" (EEPROM write) set will shorten the life of the EEPROM.



REMARKS

- When "1" (write to RAM only) is set in Pr. 342, powering OFF the inverter will erase the changed parameter values. Therefore, the parameter values available when power is switched ON again are the values stored in EEPROM previously.

5.5 Control mode

V/F control (initial setting), Advanced magnetic flux vector control and General-purpose magnetic flux vector control are available with this inverter.

(1) V/F Control

- It controls frequency and voltage so that the ratio of frequency (F) to voltage (V) is constant when changing frequency.

(2) Advanced (General-purpose) magnetic flux vector control

- This control divides the inverter output current into an excitation current and a torque current by vector calculation and makes voltage compensation to flow a motor current which meets the load torque.
- General-purpose magnetic flux vector control is the same function as the FR-E500 series. For other cases, select Advanced magnetic flux vector control.



POINT

If the following conditions are not satisfied, select V/F control since malfunction such as insufficient torque and uneven rotation may occur.

- The motor capacity should be equal to or one rank lower than the inverter capacity. (note that the capacity should be 0.1kW or higher)
- Motor to be used is any of Mitsubishi standard motor (SF-JR 0.2kW or higher), high efficiency motor (SF-HR 0.2kW or higher) or Mitsubishi constant-torque motor (SF-JRCA four-pole, SF-HRCA 0.2kW to 15kW). When using a motor other than the above (other manufacturer's motor), perform offline auto tuning without fail.
- Single-motor operation (one motor run by one inverter) should be performed.
- Wiring length from inverter to motor should be within 30m. (Perform offline auto tuning in the state where wiring work is performed when the wiring length exceeds 30m.)

5.5.1 Changing the control method (Pr. 80, Pr. 81, Pr. 800)

Set when selecting the control method for Advanced magnetic flux vector control and General-purpose magnetic flux vector control. The initial value is V/F control.

- Select a control mode using *Pr. 800 Control method selection*.

Parameter Number	Name	Initial Value	Setting Range	Description	
80	Motor capacity	9999	0.1 to 15kW	Set the applied motor capacity.	
			9999	V/F control	
81	Number of motor poles	9999	2, 4, 6, 8, 10	Set the number of motor poles.	
			9999	V/F control	
800	Control method selection	20	20	V/F	Advanced magnetic flux vector control *
			30	control	General-purpose magnetic flux vector control *

* Set a value other than "9999" in *Pr. 80* and *Pr. 81*.

(1) Setting of the motor capacity and the number of motor poles (Pr. 80, Pr. 81)

- Motor specifications (motor capacity and number of motor poles) must be set to select Advanced magnetic flux vector control or General-purpose magnetic flux vector control.
- Set the motor capacity (kW) in *Pr. 80 Motor capacity* and set the number of motor poles in *Pr. 81 Number of motor poles*.

(2) Selection of control method

- Select the inverter control method for V/F control, Advanced magnetic flux vector control, and General-purpose magnetic flux vector control.

<i>Pr. 80, 81</i>	<i>Pr. 800 Setting</i>	Control Method
Other than 9999	20 (<i>Pr. 800</i> initial value)	Advanced magnetic flux vector control
	30	General-purpose magnetic flux vector control
9999 (<i>Pr. 80, Pr. 81</i> initial value)	— *	V/F control

* Control method is V/F control regardless of the setting value of *Pr. 800* when "9999" is set in *Pr. 80 Motor capacity* or *Pr. 81 Number of motor poles*.

(3) Control method switching by CC-Link communication (X18 signal)

- Use the V/F switchover signal (X18) to change the control method (between V/F control and Advanced magnetic flux vector control (General-purpose magnetic flux vector control)) with CC-Link communication.
- Turn the X18 signal ON to change the currently selected control method (Advanced magnetic flux vector control or General-purpose magnetic flux vector control) to V/F control.

To input the X18 signal to a virtual terminal of CC-Link communication, set "18" in one of *Pr. 180 to Pr. 184 (input terminal function selection)*.

REMARKS

Switch the control method using X18 signal during an inverter stop. If control method between V/F control and Advanced (General-purpose) magnetic flux vector control is switched during the operation, the actual switchover does not take place until the inverter stops. In addition, if control method is switched to V/F control during the operation, only second function becomes valid as V/F control and second function are selected simultaneously in V/F control.

NOTE

- Changing the assignment of a virtual terminal of CC-Link communication with *Pr. 180 to Pr. 184 (input terminal function selection)* may affect other functions. Set parameters after confirming the function of each virtual terminal.

Parameters referred to

Advanced magnetic flux vector control Refer to page 114
 General-purpose magnetic flux vector control Refer to page 117
Pr. 180 to Pr. 184 (input terminal function selection) Refer to page 163
Pr. 450 Second applied motor Refer to page 144
Pr. 44 Second acceleration/deceleration time, Pr. 45 Second deceleration time Refer to page 135
Pr. 46 Second torque boost Refer to page 113
Pr. 47 Second V/F (base frequency) Refer to page 126
Pr. 48 Second stall prevention operation current Refer to page 120
Pr. 51 Second electronic thermal O/L relay Refer to page 142

5.6 Adjustment of the output torque (current) of the motor

Purpose	Parameter that should be Set		Refer to Page
Set starting torque manually	Manual torque boost	Pr. 0, Pr. 46	113
Automatically control output current according to load	Advanced magnetic flux vector control, General-purpose magnetic flux vector control	Pr. 71, Pr. 80, Pr. 81, Pr. 89, Pr. 90, Pr. 450, Pr. 800	114, 117
Compensate for motor slip to secure low-speed torque	Slip compensation (V/F control and General-purpose magnetic flux vector control only)	Pr. 245 to Pr. 247	119
Limit output current to prevent inverter trip	Stall prevention operation	Pr. 22, Pr. 23, Pr. 66, Pr. 156, Pr. 157	120

5.6.1 Manual torque boost (Pr. 0, Pr. 46)

You can compensate for a voltage drop in the low-frequency range to improve motor torque reduction in the low-speed range.

- Motor torque in the low-frequency range can be adjusted to the load to increase the starting motor torque.
- Two kinds of start torque boosts can be changed by switching the RT signal.

Parameter Number	Name	Initial Value		Setting Range	Description
0	Torque boost	0.1K to 0.75K	6%	0 to 30%	Set the output voltage at 0Hz as %.
		1.5K to 3.7K	4%		
		5.5K, 7.5K	3%		
		11K, 15K	2%		
46 *	Second torque boost	9999		0 to 30%	Set the torque boost when the RT signal is ON.
				9999	Without second torque boost

* The above parameters can be set when Pr. 160 User group read selection = "0". (Refer to page 197)

(1) Starting torque adjustment

- On the assumption that Pr. 19 Base frequency voltage is 100%, set the output voltage at 0Hz in % to Pr. 0 (Pr. 46).
- Adjust the parameter little by little (about 0.5%), and check the motor status each time. If the setting is too large, the motor will overheat. The guideline is about 10% at the greatest.

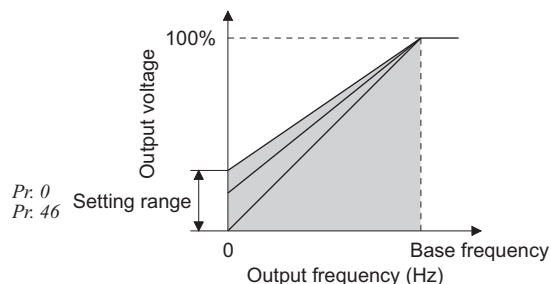

(2) Set two kinds of torque boosts (RT signal, Pr. 46)

- When you want to change torque boost according to applications, switch multiple motors with one inverter, etc., use *Second torque boost*.
- Pr. 46 *Second torque boost* is valid when the RT signal is ON.
- To input the RT signal to a virtual terminal of CC-Link communication, set "3" in one of Pr. 180 to Pr. 184 (*input terminal function selection*).



REMARKS

- The RT signal acts as the second function selection signal and makes the other second functions valid. (Refer to page 165)





NOTE

- The amount of current flows in the motor may become large according to the conditions such as the motor characteristics, load, acceleration/deceleration time, wiring length, etc., resulting in an overcurrent trip (OL (overcurrent alarm) then E.OC1 (overcurrent trip during acceleration), overload trip (E.THM (motor overload trip), or E.THT (inverter overload trip). (When a fault occurs, release the start command, and decrease the Pr. 0 setting 1% by 1% to reset.) (Refer to page 232.)
- The Pr. 0, Pr. 46 settings are valid only when V/F control is selected.
- When using the inverter dedicated motor (constant-torque motor) with the 5.5K(SC), 7.5K(SC), set torque boost value to 2%.
When Pr. 0 = "3%" (initial value), if Pr. 71 value is changed to the setting for use with a constant-torque motor, the Pr. 0 setting changes to 2%.
- Changing the assignment of a virtual terminal of CC-Link communication with Pr. 180 to Pr. 184 (*input terminal function selection*) may affect other functions. Set parameters after confirming the function of each virtual terminal.



Parameters referred to

- Pr. 3 Base frequency, Pr. 19 Base frequency voltage  Refer to page 126
- Pr. 71 Applied motor  Refer to page 144
- Pr. 180 to Pr. 184 (*input terminal function selection*)  Refer to page 163

5.6.2 Advanced magnetic flux vector control (Pr. 71, Pr. 80, Pr. 81, Pr.89, Pr. 800)

Advanced magnetic flux vector control can be selected by setting the capacity, poles and type of the motor used in Pr. 80 and Pr. 81.

- Advanced magnetic flux vector control?

The low speed torque can be improved by providing voltage compensation to flow a motor current which meets the load torque. Output frequency compensation (slip compensation) is made so that the motor actual speed approximates a speed command value. Effective when load fluctuates drastically, etc.

When the FR-E500 series used for General-purpose magnetic flux vector control was replaced, select General-purpose magnetic flux vector control only when the same operation characteristic is necessary. (Refer to page 117)

Parameter Number	Name	Initial Value	Setting Range	Description
71	Applied motor	0	0,1, 3 to 6, 13 to 16, 23, 24 40, 43, 44 50, 53, 54	By selecting a standard motor or constant-torque motor, thermal characteristic and motor constants of each motor are set.
80	Motor capacity	9999	0.1 to 15kW	Set the applied motor capacity.
			9999	V/F control
81	Number of motor poles	9999	2, 4, 6, 8, 10	Set the number of motor poles.
			9999	V/F control
89	Speed control gain (Advanced magnetic flux vector)	9999	0 to 200%	Motor speed fluctuation due to load fluctuation is adjusted during Advanced magnetic flux vector control. 100% is a referenced value.
			9999	Gain matching with the motor set in Pr.71.
800	Control method selection	20	20	Advanced magnetic flux vector control *
			30	General-purpose magnetic flux vector control * (Refer to page 117)

The above parameters can be set when Pr. 160 User group read selection = "0".(Refer to page 197)

* Set a value other than "9999" in Pr. 80 and Pr. 81.



POINT

If the following conditions are not satisfied, select V/F control since malfunction such as insufficient torque and uneven rotation may occur.

- The motor capacity should be equal to or one rank lower than the inverter capacity. (Note that the capacity should be 0.1kW or higher.)
- Motor to be used is any of Mitsubishi standard motor (SF-JR 0.2kW or higher), high efficiency motor (SF-HR 0.2kW or higher) or Mitsubishi constant-torque motor (SF-JRCA four-pole, SF-HRCA 0.2kW to 15kW). When using a motor other than the above (other manufacturer's motor), perform offline auto tuning without fail.
- Single-motor operation (one motor run by one inverter) should be performed.
- The wiring length from inverter to motor should be within 30m. (Perform offline auto tuning in the state where wiring work is performed when the wiring length exceeds 30m.)
- Permissible wiring length between inverter and motor differs according to the inverter capacity and setting value of Pr. 72 PWM frequency selection (carrier frequency). Refer to page 19 for the permissible wiring length.

<Selection method of Advanced magnetic flux vector control>

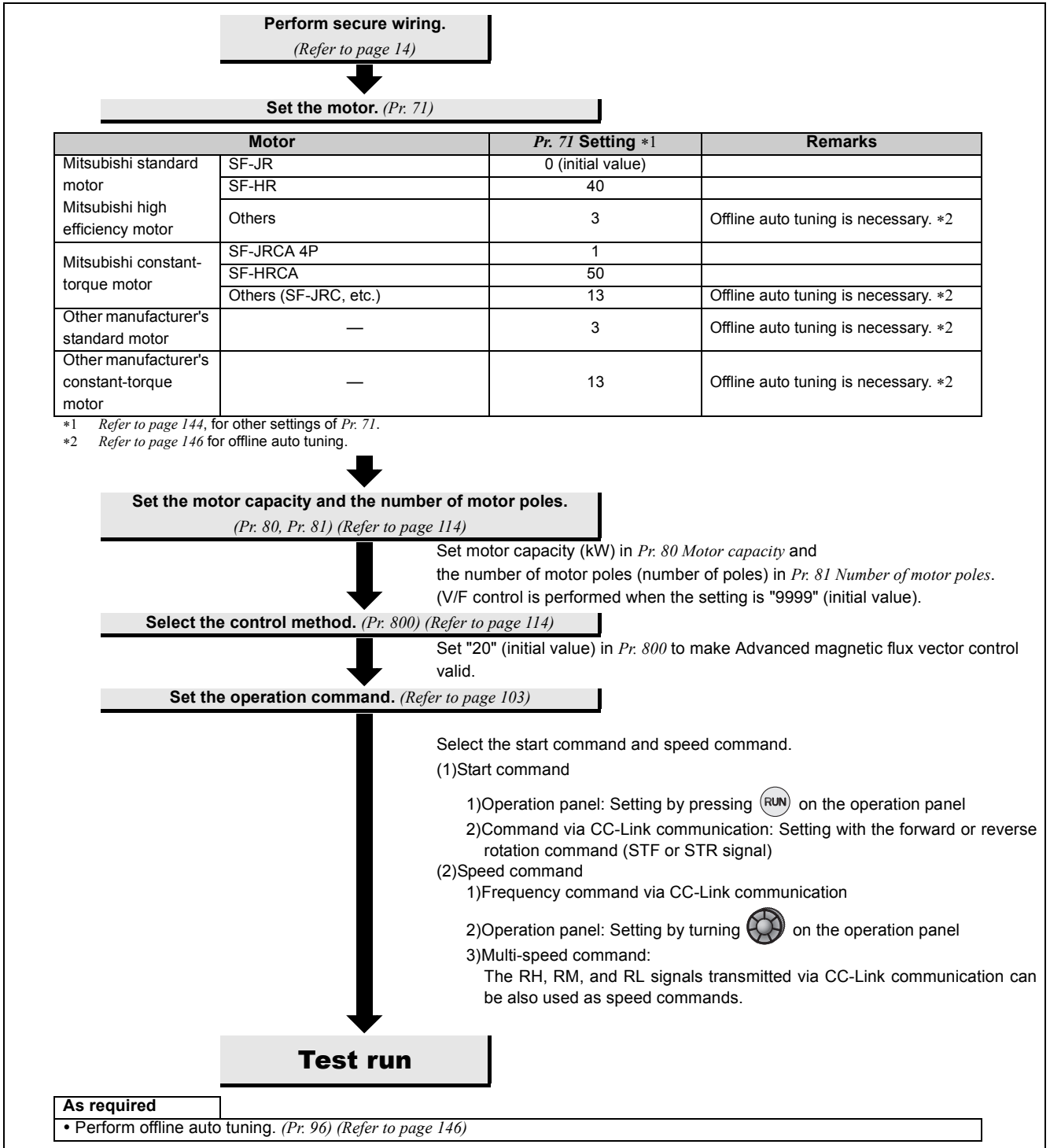

NOTE

- Uneven rotation slightly increases as compared to the V/F control. (It is not suitable for machines such as grinding machine and wrapping machine which requires less uneven rotation at low speed.)
- When a surge voltage suppression filter (FR-ASF-H/FR-BMF-H) is connected between the inverter and motor, output torque may decrease.

➤ Adjustment of the output torque (current) of the motor

(1) Adjust the motor speed fluctuation at load fluctuation (*Pr. 89 Speed control gain (Advanced magnetic flux vector)*)

The motor speed fluctuation at load fluctuation can be adjusted using *Pr. 89*. (It is useful when the speed command does not match the motor speed after the FR-E500 series inverter is replaced with the FR-E700 series inverter, etc.)

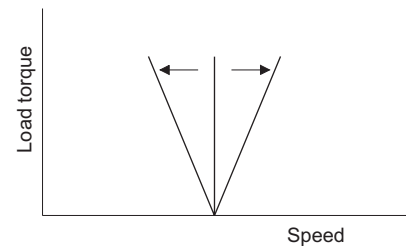

Parameters referred to

Pr. 71, Pr. 450 Applied motor Refer to page 144

Pr. 800 Control method selection Refer to page 112

5.6.3 General-purpose magnetic flux vector control (Pr. 71, Pr. 80, Pr. 81, Pr. 800)

General-purpose magnetic flux vector control is the same function as the FR-E500 series. Select this control when the same operation characteristic is necessary. For other cases, select Advanced magnetic flux vector control. (Refer to page 114)

Parameter Number	Name	Initial Value	Setting Range	Description
71	Applied motor	0	0, 1, 3 to 6, 13 to 16, 23, 24, 40, 43, 44, 50, 53, 54	By selecting a standard motor or constant-torque motor, thermal characteristic and motor constants of each motor are set.
80	Motor capacity	9999	0.1 to 15kW	Applied motor capacity.
			9999	V/F control
81	Number of motor poles	9999	2, 4, 6, 8, 10	Number of motor poles.
			9999	V/F control
800	Control method selection	20	20	Advanced magnetic flux vector control * (Refer to page 114)
			30	General-purpose magnetic flux vector control *

The above parameters can be set when Pr. 160 User group read selection = "0". (Refer to page 197)

* Set a value other than "9999" in Pr. 80 and Pr. 81 .



POINT

If the following conditions are not satisfied, select V/F control since malfunction such as insufficient torque and uneven rotation may occur.

- The motor capacity should be equal to or one rank lower than the inverter capacity. (Note that the capacity should be 0.1kW or higher.)
- Motor to be used is any of Mitsubishi standard motor (SF-JR 0.2kW or higher), high efficiency motor (SF-HR 0.2kW or higher) or Mitsubishi constant-torque motor (SF-JRCA four-pole, SF-HRCA 0.2kW to 15kW). When using a motor other than the above (other manufacturer's motor), perform offline auto tuning without fail.
- Single-motor operation (one motor run by one inverter) should be performed.
- The wiring length from inverter to motor should be within 30m. (Perform offline auto tuning in the state where wiring is performed when the wiring length exceeds 30m.)
- Permissible wiring length between inverter and motor differs according to the inverter capacity and setting value of Pr. 72 PWM frequency selection (carrier frequency). Refer to page 19 for the permissible wiring length.

Adjustment of the output torque (current) of the motor

<Selection method of General-purpose magnetic flux vector control>

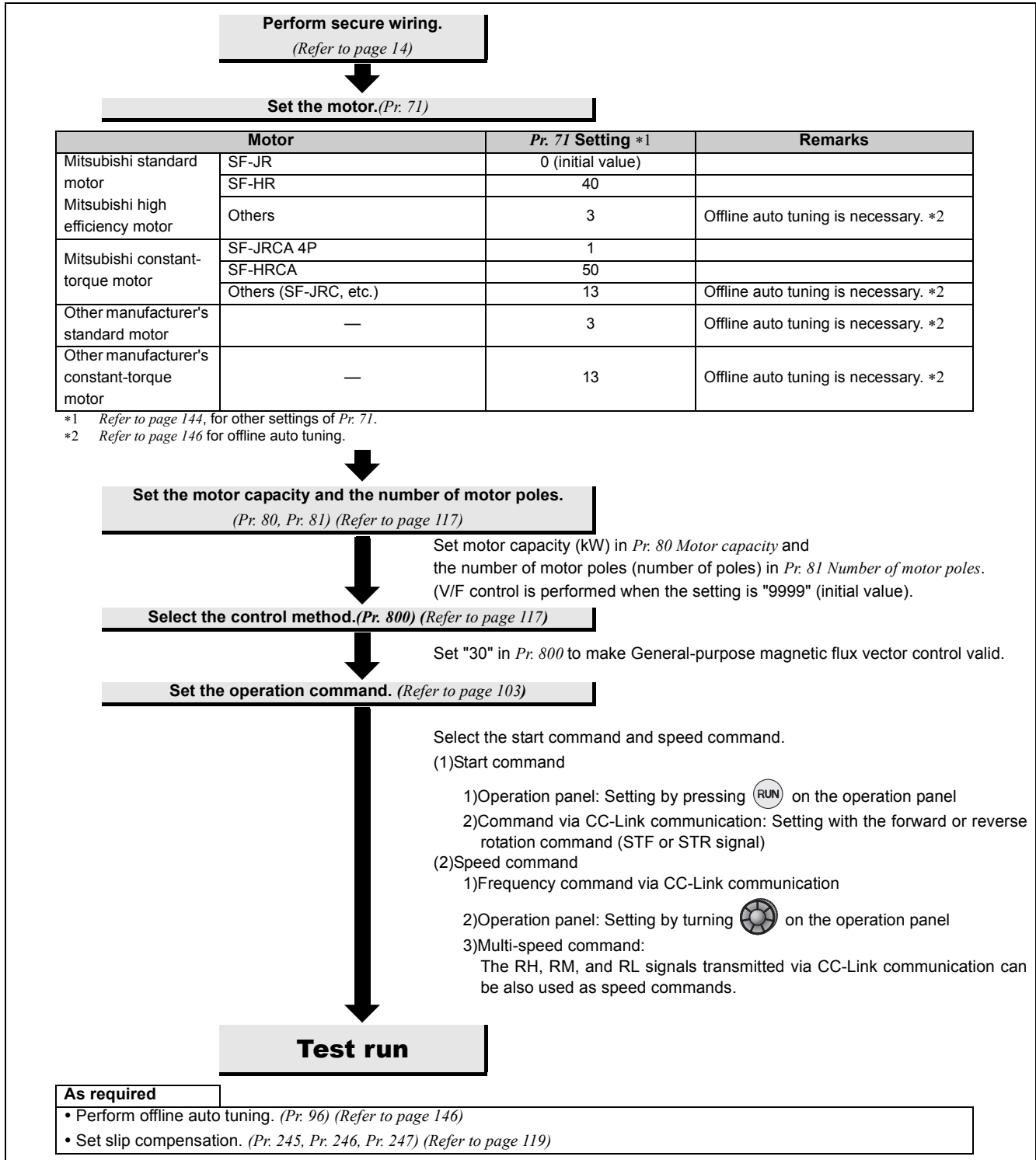



NOTE

- Uneven rotation slightly increases as compared to the V/F control. (It is not suitable for machines such as grinding machine and wrapping machine which requires less uneven rotation at low speed.)
- When a surge voltage suppression filter (FR-ASF-H/FR-BMF-H) is connected between the inverter and motor, output torque may decrease.)



Parameters referred to

Pr.3 Base frequency, Pr.19 Base frequency voltage  Refer to page 126

Pr.71 Applied motor  Refer to page 144

Pr.77 Parameter write selection  Refer to page 196

5.6.4 Slip compensation (Pr. 245 to Pr. 247)

When V/F control or General-purpose magnetic flux vector control is performed, the inverter output current may be used to assume motor slip to keep the motor speed constant.

Parameter Number	Name	Initial Value	Setting Range	Description
245	Rated slip	9999	0.01 to 50%	Rated motor slip.
			0, 9999	No slip compensation
246	Slip compensation time constant	0.5s	0.01 to 10s	Slip compensation response time. When the value is made smaller, response will be faster. However, as load inertia is greater, a regenerative overvoltage fault (E.OV□) is more liable to occur.
247	Constant-power range slip compensation selection	9999	0	Slip compensation is not made in the constant power range (frequency range above the frequency set in Pr. 3)
			9999	Slip compensation is made in the constant power range.

The above parameters can be set when Pr. 160 User group read selection = "0". (Refer to page 197)

- Slip compensation is validated when the motor rated slip calculated by the following formula is set in Pr. 245. Slip compensation is not made when Pr. 245 = "0" or "9999".

$$\text{Rated slip} = \frac{\text{Synchronous speed at base frequency} - \text{rated speed}}{\text{Synchronous speed at base frequency}} \times 100[\%]$$



REMARKS

- When performing slip compensation, the output frequency may become greater than the set frequency. Set the Pr. 1 Maximum frequency value a little higher than the set frequency.
- Slip compensation is always valid when Advanced magnetic flux vector control is selected, the Pr. 245 to Pr. 247 settings are invalid.



Parameters referred to

- Pr. 1 Maximum frequency Refer to page 124
- Pr. 3 Base frequency Refer to page 126

Adjustment of the output torque (current) of the motor

5.6.5 Stall prevention operation (Pr. 22, Pr. 23, Pr. 48, Pr. 66, Pr. 156, Pr. 157, Pr. 277)

This function monitors the output current and automatically changes the output frequency to prevent the inverter from coming to trip due to overcurrent, overvoltage, etc. In addition, simple torque limit which limits the output torque to the predetermined value can be selected.

It can also limit stall prevention and fast-response current limit operation during acceleration/deceleration, driving or regeneration.

- Stall prevention

If the output current exceeds the stall prevention operation level, the output frequency of the inverter is automatically varied to reduce the output current.

- Fast-response current limit

If the current exceeds the limit value, the output of the inverter is shut off to prevent an overcurrent.

- Torque limit

The inverter output frequency is controlled so that the output torque (torque current) will not exceed the stall prevention operation level (motor rated torque is referenced).

Parameter Number	Name	Initial Value	Setting Range	Description
22*	Stall prevention operation level	150%	0	Stall prevention operation invalid
			0.1 to 200%	Set the current value to start the stall prevention operation.
23	Stall prevention operation level compensation factor at double speed	9999	0 to 200%	The stall operation level can be reduced when operating at a high speed above the rated frequency.
			9999	Constant according to Pr. 22.
48	Second stall prevention operation current	9999	0	Stall prevention operation invalid
			0.1 to 200%	Second stall prevention operation level
			9999	Same level as Pr. 22.
66	Stall prevention operation reduction starting frequency	60Hz	0 to 400Hz	Set the frequency at which the stall prevention operation level starts being reduced.
156	Stall prevention operation selection	0	0 to 31, 100, 101	Select whether stall prevention operation and fast-response current limit operation will be performed or not.
157	OL signal output timer	0s	0 to 25s	Output start time of the OL signal output when stall prevention is activated.
			9999	Without the OL signal output
277	Stall prevention operation current switchover	0	0	Output current is the limit level
			1	Output torque (torque current) is the limit level

The above parameters can be set when Pr. 160 User group read selection = "0". (Refer to page 197)

* This parameter allows its setting to be changed during operation in any operation mode even if "0 (initial value) or 1" is set in Pr. 77 Parameter write selection.

(1) Block diagram

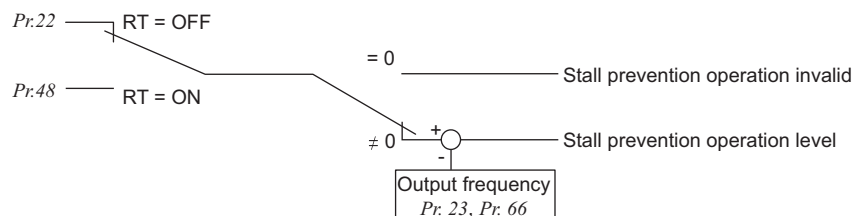

(2) Setting of stall prevention operation level (Pr. 22)

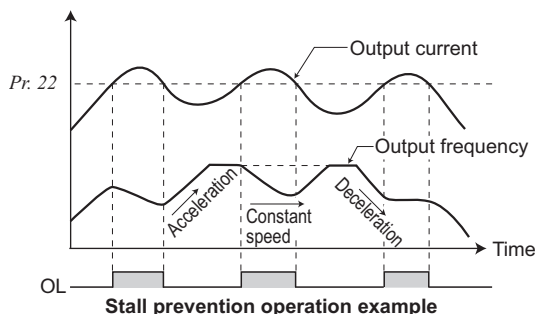

- Set in Pr. 22 the percentage of the output current to the rated inverter current at which stall prevention operation will be performed. Normally set this parameter to 150% (initial value).
- Stall prevention operation stops acceleration (makes deceleration) during acceleration, makes deceleration during constant speed, and stops deceleration (makes acceleration) during deceleration.
- When stall prevention operation is performed, the OL signal is output.



NOTE

- If an overload status lasts long, an inverter trip (e.g. electronic thermal O/L relay (E.THM)) may occur.

(3) A machine protection and load limit by torque limit (Pr. 277)

- When Pr. 277 Stall prevention current switchover = "1", torque limit can be set.
- When output torque (torque current) exceeds the stall prevention operation level, the output frequency is controlled to limit the output torque. For the stall prevention operation level at this time, the motor rated torque is defined as reference.



REMARKS

- When driving multiple motors with one inverter, torque limit does not function properly.
- Since magnetic flux decreases in the constant output range (Pr. 3 Base frequency or more), the inverter operate with lower torque than the stall prevention operation level.
- When torque limit is activated during regeneration, the output frequency is increased up to the maximum frequency.
- Torque limit does not function at 5Hz or less during deceleration.
- Note the following when using torque limit under V/F control.
 - (a) Capacity of the inverter and motor should be the same.
 - (b) Stall prevention operation level (torque limit level) is the rated torque reference of the motor whose capacity is equivalent to the inverter.
 - (c) When Pr. 0 Torque boost setting is large, torque limit is likely to occur in the low speed range.
 - (d) Use the Advanced magnetic flux vector control when more appropriate torque limit is necessary.

(4) Stall prevention operation signal output and output timing adjustment (OL signal, Pr. 157)

- When the output current exceeds the stall prevention operation level and stall prevention is activated, the stall prevention operation signal (OL signal) turns ON for longer than 100ms. When the output current falls to or below the stall prevention operation level, the output signal turns OFF.
- Use Pr. 157 OL signal output timer to set whether the OL signal is output immediately or after a preset period of time.
- This operation is also performed when the regeneration avoidance function or (overvoltage stall) is executed.
- To assign the OL signal to the terminal Y0 or a virtual terminal of CC-Link communication, set "3 (positive logic) or 103 (negative logic)" in one of Pr. 190 to Pr. 192 and Pr. 313 to Pr. 315 (output terminal function selection).

Pr. 157 Setting	Description
0 (initial value)	Output immediately.
0.1 to 25	Output after the set time (s) has elapsed.
9999	Not output.

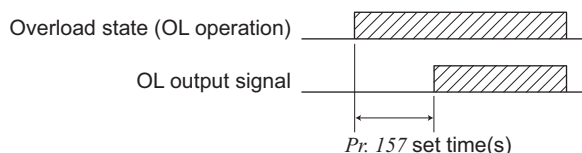

NOTE

- If the frequency has fallen to 1Hz by stall prevention operation and remains for 3s, a fault (E.OLT) appears to trip the inverter output.
- Changing the assignment of the terminal Y0 or a virtual terminal of CC-Link communication with one of Pr. 190 to Pr. 192, and Pr. 313 to Pr. 315 (output terminal function selection) may affect other functions. Set parameters after confirming the function of the terminal Y0 and virtual terminals.

Adjustment of the output torque (current) of the motor

(5) Setting of stall prevention operation in high frequency range (Pr. 22, Pr. 23, Pr. 66)

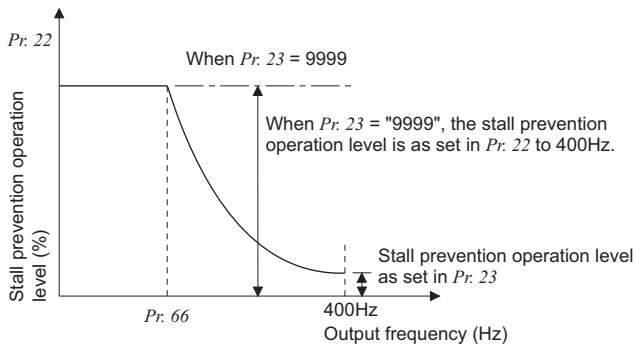

Setting example (Pr. 22 = 150%, Pr. 23 = 100%, Pr. 66 = 60Hz)

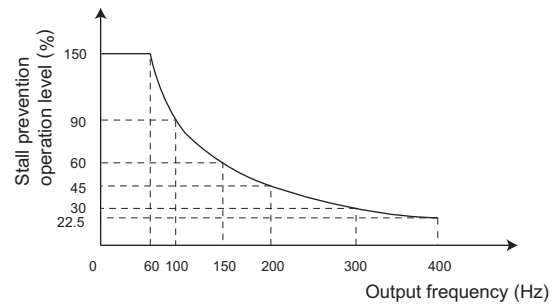

• During high-speed operation above the rated motor frequency, acceleration may not be made because the motor current does not increase. If operation is performed in a high frequency range, the current at motor lockup becomes smaller than the rated output current of the inverter, and the protective function (OL) is not executed even if the motor is at a stop.

To improve the operating characteristics of the motor in this case, the stall prevention level can be reduced in the high frequency range. This function is effective for performing operation up to the high-speed range on a centrifugal separator etc. Normally, set 60Hz in Pr. 66 and 100% in Pr. 23.

• Formula for stall prevention operation level

$$\text{Stall prevention operation level in high frequency range (\%)} = A + B \times \left[\frac{\text{Pr. 22} - A}{\text{Pr. 22} - B} \right] \times \left[\frac{\text{Pr. 23} - 100}{100} \right]$$

$$\text{However, } A = \frac{\text{Pr. 66 (Hz)} \times \text{Pr. 22 (\%)}}{\text{Output frequency (Hz)}}, \quad B = \frac{\text{Pr. 66 (Hz)} \times \text{Pr. 22 (\%)}}{400\text{Hz}}$$

• By setting "9999" (initial value) in Pr. 23 *Stall prevention operation level compensation factor at double speed*, the stall prevention operation level is constant at the Pr. 22 setting up to 400Hz.

(6) Set two types of stall prevention operation levels (Pr. 48)

• Turning RT signal ON makes Pr. 48 *Second stall prevention operation current* valid.

• To input the RT signal to a virtual terminal of CC-Link communication, set "3" in one of Pr. 180 to Pr. 184 (*input terminal function selection*).



NOTE

- Changing the assignment of a virtual terminal of CC-Link communication with Pr. 180 to Pr. 184 (*input terminal function selection*) may affect other functions. Set parameters after confirming the function of each virtual terminal.
- The RT signal acts as the second function selection signal and makes the other second functions valid. (Refer to page 165)

(7) Limit the stall prevention operation and fast-response current limit operation according to the operating status (Pr. 156)

Refer to the following table and select whether stall prevention operation and fast-response current limit operation will be performed or not and the operation to be performed at OL signal output.

Pr. 156 Setting	Fast-Response Current Limit*4 ○: Activated ●: Not activated	Stall Prevention Operation Selection ○: Activated ●: Not activated			OL Signal Output ○: Operation continued ●: Operation not continued*1
		Acceleration	Constant speed	Deceleration	
0 (initial value)	○	○	○	○	○
1	●	○	○	○	○
2	○	●	○	○	○
3	●	●	○	○	○
4	○	○	●	○	○
5	●	○	●	○	○
6	○	●	●	○	○
7	●	●	●	○	○
8	○	○	○	●	○
9	●	○	○	●	○
10	○	●	○	●	○
11	●	●	○	●	○
12	○	○	●	●	○
13	●	○	●	●	○
14	○	●	●	●	—*2
15	●	●	●	●	—*2

Pr. 156 Setting	Fast-Response Current Limit*4 ○: Activated ●: Not activated	Stall Prevention Operation Selection ○: Activated ●: Not activated			OL Signal Output ○: Operation continued ●: Operation not continued*1
		Acceleration	Constant speed	Deceleration	
16	○	○	○	○	●
17	●	○	○	○	●
18	○	●	○	○	●
19	●	●	○	○	●
20	○	○	●	○	●
21	●	○	●	○	●
22	○	●	●	○	●
23	●	●	●	○	●
24	○	○	○	●	●
25	●	○	○	●	●
26	○	●	○	●	●
27	●	●	○	●	●
28	○	○	●	●	●
29	●	○	●	●	●
30	○	●	●	●	—*2
31	●	●	●	●	—*2

100*3	Power driving	○	○	○	○	○
	Regeneration	●	●	●	●	—*2

101*3	Power driving	●	○	○	○	○
	Regeneration	●	●	●	●	—*2

*1 When "Operation not continued for OL signal output" is selected, the **E.OLT** fault (stopped by stall prevention) is displayed and operation stopped.
 *2 Since stall prevention is not activated, OL signal and E.OLT are not output.
 *3 The settings "100" and "101" allow operations to be performed in the driving and regeneration modes, respectively. The setting "101" disables the fast-response current limit in the driving mode.
 *4 OL signal is not output at fast-response current limit operation.



NOTE

- When the load is heavy or the acceleration/deceleration time is short, stall prevention is activated and acceleration/deceleration may not be made according to the preset acceleration/deceleration time. Set Pr. 156 and stall prevention operation level to the optimum values.
- In vertical lift applications, make setting so that the fast-response current limit is not activated. Torque may not be produced, causing a load drop due to gravity.

CAUTION

- Do not set a small value as the stall prevention operation current. Otherwise, torque generated will reduce.
- Test operation must be performed.
 - Stall prevention operation during acceleration may increase the acceleration time.
 - Stall prevention operation performed during constant speed may cause sudden speed changes.
 - Stall prevention operation during deceleration may increase the deceleration time, increasing the deceleration distance.



Parameters referred to

- Pr. 3 Base frequency Refer to page 126
- Pr. 180 to Pr. 184 (input terminal function selection) Refer to page 163
- Pr. 190 to Pr. 192, Pr. 313 to Pr. 315 (output terminal function selection) Refer to page 167

5.7 Limiting the output frequency

Purpose	Parameter that should be Set		Refer to Page
Set upper limit and lower limit of output frequency	Maximum/minimum frequency	Pr. 1, Pr. 2, Pr. 18	124
Perform operation by avoiding mechanical resonance points	Frequency jump	Pr. 31 to Pr. 36	125

5.7.1 Maximum/minimum frequency (Pr. 1, Pr. 2, Pr. 18)

Motor speed can be limited.

Clamp the upper and lower limits of the output frequency.

Parameter Number	Name	Initial Value	Setting Range	Description
1	Maximum frequency	120Hz	0 to 120Hz	Upper limit of the output frequency.
2	Minimum frequency	0Hz	0 to 120Hz	Lower limit of the output frequency.
18 *	High speed maximum frequency	120Hz	120 to 400Hz	Set when performing the operation at 120Hz or more.

* The above parameters can be set when Pr. 160 User group read selection = "0". (Refer to page 197)

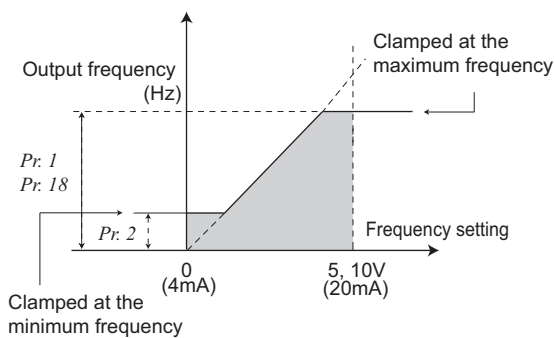

(1) Set maximum frequency

- Use Pr. 1 Maximum frequency to set the maximum frequency. If the value of the frequency command entered is higher than the setting, the output frequency is clamped at the maximum frequency.
- When you want to perform operation above 120Hz, set the upper limit of the output frequency to Pr. 18 High speed maximum frequency. (When Pr. 18 is set, Pr. 1 automatically switches to the frequency of Pr. 18. Also, when Pr. 1 is set, Pr. 18 is automatically changed to the frequency set in Pr. 1.

(2) Set minimum frequency

- Use Pr. 2 Minimum frequency to set the minimum frequency.
- If the set frequency is less than Pr. 2, the output frequency is clamped at Pr. 2 (will not fall below Pr. 2).

REMARKS

- When Pr. 15 Jog frequency is equal to or less than Pr. 2, the Pr. 15 setting has precedence over the Pr. 2 setting.
- When stall prevention is activated to decrease the output frequency, the output frequency may drop to Pr. 2 or below.

CAUTION

⚠ Note that when Pr. 2 is set to any value equal to or more than Pr. 13 Starting frequency, simply turning ON the start signal will run the motor at the preset frequency according to the set acceleration time even if the command frequency is not input.



Parameters referred to

- Pr. 13 Starting frequency Refer to page 138
- Pr. 15 Jog frequency Refer to page 201

5.7.2 Avoiding mechanical resonance points (frequency jumps) (Pr. 31 to Pr. 36)

When avoiding resonance arisen from the natural frequency of a mechanical system, use these parameters to jump the resonant frequencies.

Parameter Number	Name	Initial Value	Setting Range	Description
31	Frequency jump 1A	9999	0 to 400Hz, 9999	1A to 1B, 2A to 2B, 3A to 3B is frequency jumps 9999: Function invalid
32	Frequency jump 1B	9999	0 to 400Hz, 9999	
33	Frequency jump 2A	9999	0 to 400Hz, 9999	
34	Frequency jump 2B	9999	0 to 400Hz, 9999	
35	Frequency jump 3A	9999	0 to 400Hz, 9999	
36	Frequency jump 3B	9999	0 to 400Hz, 9999	

The above parameters can be set when Pr. 160 User group read selection = "0". (Refer to page 197)

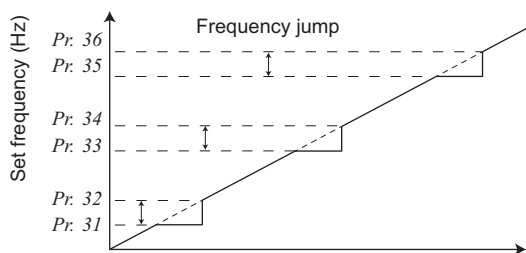

- Up to three areas can be set, with the jump frequencies set to either the top or bottom point of each area.
- The value set to 1A, 2A or 3A is a jump point and operation in the jump zone is performed at these frequencies.

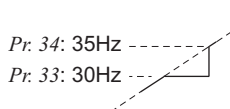

Example 1 To fix the frequency to 30Hz in the range 30Hz to 35Hz, set 35Hz in Pr. 34 and 30Hz in Pr. 33.

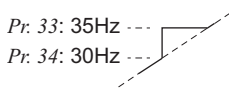

Example 2 To jump the frequency to 35Hz in the range 30Hz to 35Hz, set 35Hz in Pr. 33 and 30Hz in Pr. 34.



NOTE

During acceleration/deceleration, the running frequency within the set area is valid.

5.8 V/F pattern

Purpose	Parameter that should be Set		Refer to Page
Set motor ratings	Base frequency, Base frequency voltage	Pr. 3, Pr. 19, Pr. 47	126
Select a V/F pattern according to applications.	Load pattern selection	Pr. 14	128

5.8.1 Base frequency, voltage (Pr. 3, Pr. 19, Pr. 47)

Use this function to adjust the inverter outputs (voltage, frequency) to match with the motor rating.

Parameter Number	Name	Initial Value	Setting Range	Description
3	Base frequency	60Hz	0 to 400Hz	Rated motor frequency. (50Hz/60Hz)
19 *	Base frequency voltage	9999	0 to 1000V	Base voltage.
			8888	95% of power supply voltage
			9999	Same as power supply voltage
47 *	Second V/F (base frequency)	9999	0 to 400Hz	Base frequency when the RT signal is ON.
			9999	Second V/F invalid

* The above parameters can be set when Pr. 160 User group read selection = "0". (Refer to page 197)

(1) Base frequency setting (Pr. 3)

- When operating a standard motor, generally set the rated frequency of the motor to Pr. 3 Base frequency. When running the motor using commercial power supply-inverter switch-over operation, set Pr. 3 to the same value as the power supply frequency.
- If the frequency given on the motor rating plate is "50Hz" only, always set to "50Hz". Leaving the base frequency unchanged from "60Hz" may make the voltage too low and the torque insufficient. It may result in an inverter trip due to overload. Special care must be taken when "1" (variable torque load) is set in Pr. 14 Load pattern selection .
- When using the Mitsubishi constant-torque motor, set Pr. 3 to 60Hz.

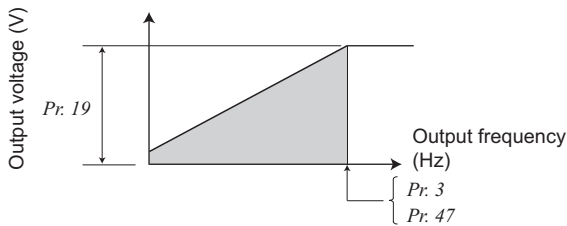

(2) Set two kinds of base frequencies (Pr. 47)

- When you want to change the base frequency when switching two types of motors with one inverter, use the Pr. 47 Second V/F (base frequency).
- Pr. 47 Second V/F (base frequency) is valid when the RT signal is ON. Set "3" in any of Pr. 180 to Pr. 184 (input terminal function selection) and assign the RT signal.

REMARKS

- The RT signal acts as the second function selection signal and makes the other second functions valid. (Refer to page 165)

(3) Base frequency voltage setting (Pr. 19)

- Use Pr. 19 *Base frequency voltage* to set the base voltage (e.g. rated motor voltage).
- If the setting is less than the power supply voltage, the maximum output voltage of the inverter is as set in Pr. 19.
- Pr. 19 can be utilized in the following cases.
 - (a) When regeneration is high (e.g. continuous regeneration)







During regeneration, the output voltage becomes higher than the reference and may cause an overcurrent trip (E.OC□) due to an increased motor current.
 - (b) When power supply voltage variation is large

When the power supply voltage exceeds the rated voltage of the motor, speed variation or motor overheat may be caused by excessive torque or increased motor current.

**NOTE**

- When **Advanced magnetic flux vector control** or **General-purpose magnetic flux vector control** is selected, Pr. 3, Pr. 47 and Pr. 19 are invalid and Pr. 83 and Pr. 84 are valid.
Note that Pr. 3 or Pr. 47 value is made valid as inflection points of S-pattern when Pr. 29 *Acceleration/deceleration pattern selection* = "1" (S-pattern acceleration/deceleration A).
- Changing the assignment of a virtual terminal of CC-Link communication with Pr. 180 to Pr. 184 (*input terminal function selection*) may affect other functions. Set parameters after confirming the function of each virtual terminal.

**Parameters referred to**

- Pr. 14 *Load pattern selection*  Refer to page 128
- Pr. 29 *Acceleration/deceleration pattern selection*  Refer to page 139
- Pr. 83 *Rated motor voltage*, Pr. 84 *Rated motor frequency*  Refer to page 146
- Pr. 180 to Pr. 184 (*input terminal function selection*)  Refer to page 163
- General-purpose magnetic flux vector control*  Refer to page 117
- Advanced magnetic flux vector control*  Refer to page 114

5.8.2 Load pattern selection (Pr. 14) 

You can select the optimum output characteristic (V/F characteristic) for the application and load characteristics.

Parameter Number	Name	Initial Value	Setting Range	Description
14	Load pattern selection	0	0	For constant-torque load
			1	For variable torque load
			2	For constant-torque elevators (at reverse rotation boost of 0%)
			3	For constant-torque elevators (at forward rotation boost of 0%)

The above parameters can be set when Pr. 160 User group read selection = "0". (Refer to page 197)

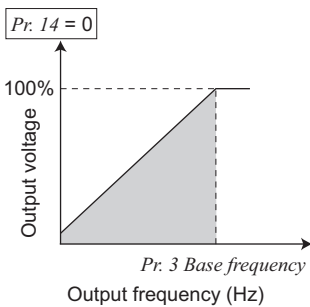

(1) Constant-torque load application (setting "0", initial value)

- At or less than the base frequency, the output voltage varies linearly with the output frequency.
- Set this value when driving the load whose load torque is constant even if the speed varies, e.g. conveyor, cart or roll drive.



POINT

If the load is a fan or pump, select for constant-torque load (setting "0") in any of the following cases.

- When a blower of large inertia moment (J) is accelerated in a short time
- For constant-torque load such as rotary pump or gear pump
- When load torque increases at low speed, e.g. screw pump

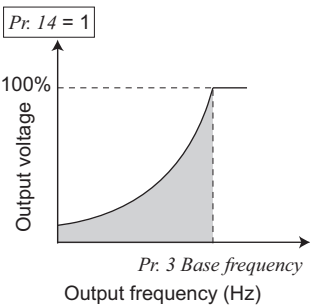

(2) Variable-torque load application (setting "1")

- At or less than the base frequency, the output voltage varies with the output frequency in a square curve.
- Set this value when driving the load whose load torque varies in proportion to the square of the speed, e.g. fan or pump.

Pr. 14 = 2

For vertical lift loads
At forward rotation boost...Pr. 0 (Pr. 46) setting
At reverse rotation boost...0%

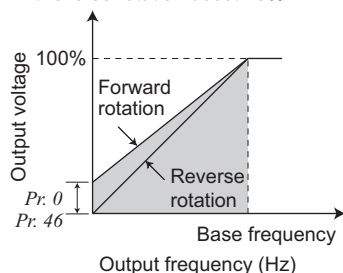

Pr. 14 = 3

For vertical lift loads
At forward rotation boost...0%
At reverse rotation boost...Pr. 0 (Pr. 46) setting

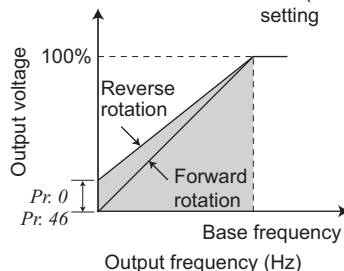

(3) Constant-torque load application (setting "2, 3")

- Set "2" when a vertical lift load is fixed as power driving load at forward rotation and regenerative load at reverse rotation.
- Pr. 0 Torque boost is valid during forward rotation and torque boost is automatically changed to "0%" during reverse rotation. Pr. 46 Second torque boost is valid when the RT signal turns ON.
- Set "3" for an elevated load that is in the driving mode during reverse rotation and in the regenerative load mode during forward rotation according to the load weight, e.g. counterweight system.
- For the RT signal, set "3" in any of Pr. 180 to Pr. 184 (input terminal function selection) to assign the function.



REMARKS

- When torque is continuously regenerated as vertical lift load, it is effective to set the rated voltage in Pr. 19 Base frequency voltage to prevent trip due to current at regeneration.
- In addition, when the RT signal is ON, the other second functions are also valid.



NOTE

- Load pattern selection does not function under Advanced magnetic flux vector control and General-purpose magnetic flux vector control.
- Changing the assignment of a virtual terminal of CC-Link communication with Pr. 180 to Pr. 184 (input terminal function selection) may affect other functions. Set parameters after confirming the function of each virtual terminal.



Parameters referred to

- Pr. 0, Pr. 46 (Torque boost) Refer to page 113
- Pr. 3 Base frequency Refer to page 126
- Pr. 180 to Pr. 184 (input terminal function selection) Refer to page 163
- General-purpose magnetic flux vector control Refer to page 114
- Advanced magnetic flux vector control Refer to page 114

5.9 Frequency setting with input signals

Purpose	Parameter that should be Set		Refer to Page
To control the frequency with combinations of input signals	Multi-speed operation	Pr. 4 to Pr. 6, Pr. 24 to Pr. 27, Pr. 232 to Pr. 239	130
To command smooth speed transition with input signals	Remote setting function	Pr. 59	132

5.9.1 Operation by multi-speed operation (Pr. 4 to Pr. 6, Pr. 24 to Pr. 27, Pr. 232 to Pr. 239)

Use the virtual terminals of CC-Link communication to switch among the pre-set operation speeds set in parameters. Any speed can be selected by simply turning ON/OFF the RH, RM, RL and REX signals.

Parameter Number	Name	Initial Value	Setting Range	Description
4	Multi-speed setting (high speed)	60Hz	0 to 400Hz	Frequency when RH turns ON
5	Multi-speed setting (middle speed)	30Hz	0 to 400Hz	Frequency when RM turns ON
6	Multi-speed setting (low speed)	10Hz	0 to 400Hz	Frequency when RL turns ON
24 *	Multi-speed setting (speed 4)	9999	0 to 400Hz, 9999	Frequency from 4 speed to 15 speed can be set according to the combination of the RH, RM, RL and REX signals. 9999: not selected
25 *	Multi-speed setting (speed 5)	9999	0 to 400Hz, 9999	
26 *	Multi-speed setting (speed 6)	9999	0 to 400Hz, 9999	
27 *	Multi-speed setting (speed 7)	9999	0 to 400Hz, 9999	
232 *	Multi-speed setting (speed 8)	9999	0 to 400Hz, 9999	
233 *	Multi-speed setting (speed 9)	9999	0 to 400Hz, 9999	
234 *	Multi-speed setting (speed 10)	9999	0 to 400Hz, 9999	
235 *	Multi-speed setting (speed 11)	9999	0 to 400Hz, 9999	
236 *	Multi-speed setting (speed 12)	9999	0 to 400Hz, 9999	
237 *	Multi-speed setting (speed 13)	9999	0 to 400Hz, 9999	
238 *	Multi-speed setting (speed 14)	9999	0 to 400Hz, 9999	
239 *	Multi-speed setting (speed 15)	9999	0 to 400Hz, 9999	

The above parameters allow its setting to be changed during operation in any operation mode even if "0" (initial value) is set in Pr. 77 Parameter write selection.

* This parameter can be set when Pr. 160 User group read selection = "0". (Refer to page 197)

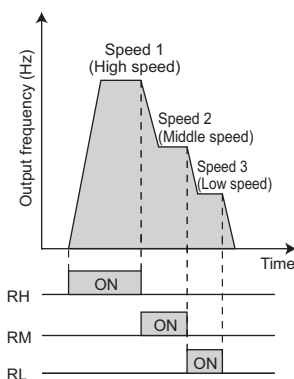

(1) Multi speed setting for 3 speeds (Pr. 4 to Pr. 6)

- The inverter operates at frequencies set in Pr. 4 when RH signal is ON, Pr. 5 when RM signal is ON and Pr. 6 when RL signal is ON.

REMARKS

- For multi-speed setting, if two or three speeds are simultaneously selected, priority is given to the set frequency of the lower signal.
For example, when the RH and RM signals turn ON, the RM signal (Pr. 5) has a higher priority.
- The RH, RM, RL signals are assigned to the virtual terminals of CC-Link communication in the initial setting. By setting "0 (RL)", "1 (RM)", "2 (RH)" in Pr. 183 or Pr. 184 (input terminal function selection), you can assign the signals to other virtual terminals.

(2) Multi-speed setting for 4 or more speeds (Pr. 24 to Pr. 27, Pr. 232 to Pr. 239)

- Frequency from 4 speed to 15 speed can be set according to the combination of the RH, RM, RL and REX signals. Set the running frequencies in Pr. 24 to Pr. 27, Pr. 232 to Pr. 239. (In the initial value setting, speed 4 to speed 15 are invalid.)
- To input the REX signal to a virtual terminal of CC-Link communication, set "8" in one of Pr.180 to Pr.184 (input terminal function selection).

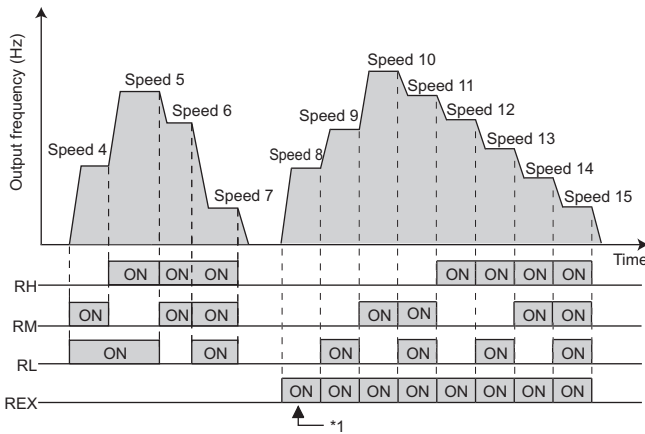

*1 When "9999" is set in Pr. 232 Multi-speed setting (speed 8), operation is performed at frequency set in Pr. 6 when RH, RM and RL are turned OFF and REX is turned ON.



REMARKS

- Multi-speed parameters can also be set in the PU operation mode.
- Pr. 24 to Pr. 27 and Pr. 232 to Pr. 239 settings have no priority between them.
- When Pr. 59 Remote function selection ≠ "0", multi-speed setting is invalid as RH, RM and RL signals are remote setting signals.





NOTE

- Changing the assignment of a virtual terminal of CC-Link communication with Pr. 180 to Pr. 184 (input terminal function selection) may affect other functions. Set parameters after confirming the function of each virtual terminal.



Parameters referred to

- Pr. 59 Remote function selection  Refer to page 132
- Pr. 180 to Pr. 184 (input terminal function selection)  Refer to page 163

5.9.2 Remote setting function (Pr. 59)

- Continuous variable-speed operation can be performed with acceleration and deceleration signals.
- By simply setting this parameter, you can use the acceleration, deceleration and setting clear functions of the remote speed setter (FR-FK).

Parameter Number	Name	Initial Value	Setting Range	Description	
				RH, RM, RL signal function	Frequency setting storage function
59	Remote function selection	0	0	Multi-speed setting	—
			1	Remote setting	With
			2	Remote setting	Not used
			3	Remote setting	Not used (Turning STF/STR OFF clears remotely-set frequency.)

The above parameters can be set when Pr. 160 User group read selection = "0". (Refer to page 156)

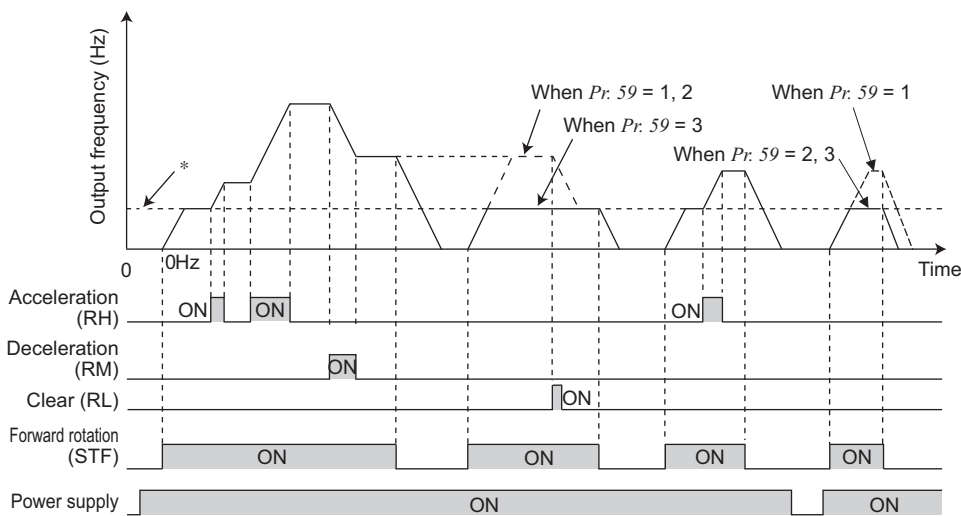

* CC-Link communication running frequency (other than multi-speed) or PU running frequency

(1) Remote setting function

- Use Pr. 59 to select whether the remote setting function is used or not and whether the frequency setting storage function in the remote setting mode is used or not.
When Pr. 59 is set to any of "1 to 3" (remote setting function valid), the functions of the RH, RM and RL signals are changed to acceleration (RH), deceleration (RM) and clear (RL).
- When using the remote setting function, following frequencies can be compensated to the frequency set by RH and RM operation according to the operation mode.
During CC-Link communication operation CC-Link communication frequency command other than multi-speed settings
During PU operation..... PU frequency command

(2) Frequency setting storage

- The frequency setting storage function stores the remotely-set frequency (frequency set by RH/RM operation) into the memory (EEPROM). When power is switched OFF once, then ON, operation is resumed with that output frequency value. (Pr. 59 = 1)

<Frequency setting storage conditions>

Remotely-set frequency is stored in the following timings.

- When the start signal (STF or STR) turns OFF.
- Every minute after both the RH (acceleration) and RM (deceleration) signals turn OFF (ON). (The frequency is overwritten if the latest frequency is different from the previous frequency when comparing the two. The state of the RL signal does not affect writing.)
- When the power supply switches to the 24V external power supply while the start signal (STF or STR) is ON. ("EV" appears on the operation panel.)



NOTE

- The range of frequency changeable by RH (acceleration) and RM (deceleration) is 0 to maximum frequency (Pr. 1 or Pr. 18 setting). Note that the maximum value of set frequency is (main speed + maximum frequency).

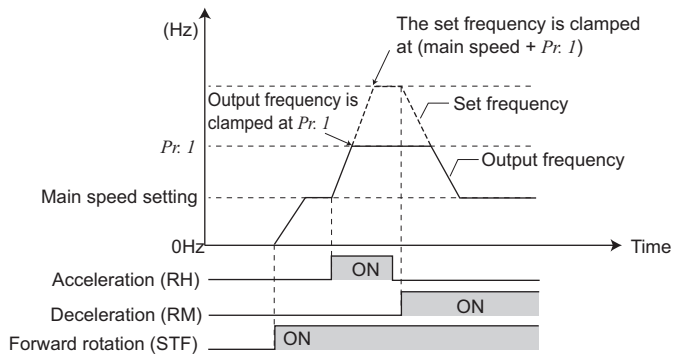

- When the acceleration or deceleration signal switches ON, acceleration/deceleration time is as set in Pr. 44 Second acceleration/deceleration time and Pr. 45 Second deceleration time. Note that when the time set in Pr. 7 or Pr. 8 is longer than the time set in Pr. 44 or Pr. 45, the acceleration/deceleration time is as set in Pr. 7 or Pr. 8. (when RT signal is OFF) When the RT signal is ON, acceleration/deceleration is made in the time set in Pr. 44 and Pr. 45, regardless of the Pr. 7 or Pr. 8 setting.
- Even if the start signal (STF or STR) is OFF, turning ON the acceleration (RH) or deceleration (RM) signal varies the preset frequency.
- When switching the start signal from ON to OFF, or changing frequency by the RH or RM signal frequently, set the frequency setting value storage function (write to EEPROM) invalid (Pr. 59 = "2, 3"). If set valid (Pr. 59 = "1"), frequency is written to EEPROM frequently, this will shorten the life of the EEPROM.
- To assign the RH, RM, or RL signal to a virtual terminal of CC-Link communication, use one of Pr. 180 to Pr. 184 (input terminal function selection). Changing the assignment of a virtual terminal may affect other functions. Set parameters after confirming the function of each virtual terminal.

REMARKS

During Jog operation or PID control operation, the remote setting function is invalid.

Setting frequency is "0"

- Even when the remotely-set frequency is cleared by turning ON the RL (clear) signal after turn OFF (ON) of both the RH and RM signals, the inverter operates at the remotely-set frequency stored in the last operation if power is reapplied before one minute has elapsed since turn OFF (ON) of both the RH and RM signals
- When the remotely-set frequency is cleared by turning ON the RL (clear) signal after turn OFF (ON) of both the RH and RM signals, the inverter operates at the frequency in the remotely-set frequency cleared state if power is reapplied after one minute has elapsed since turn OFF (ON) of both the RH and RM signals.

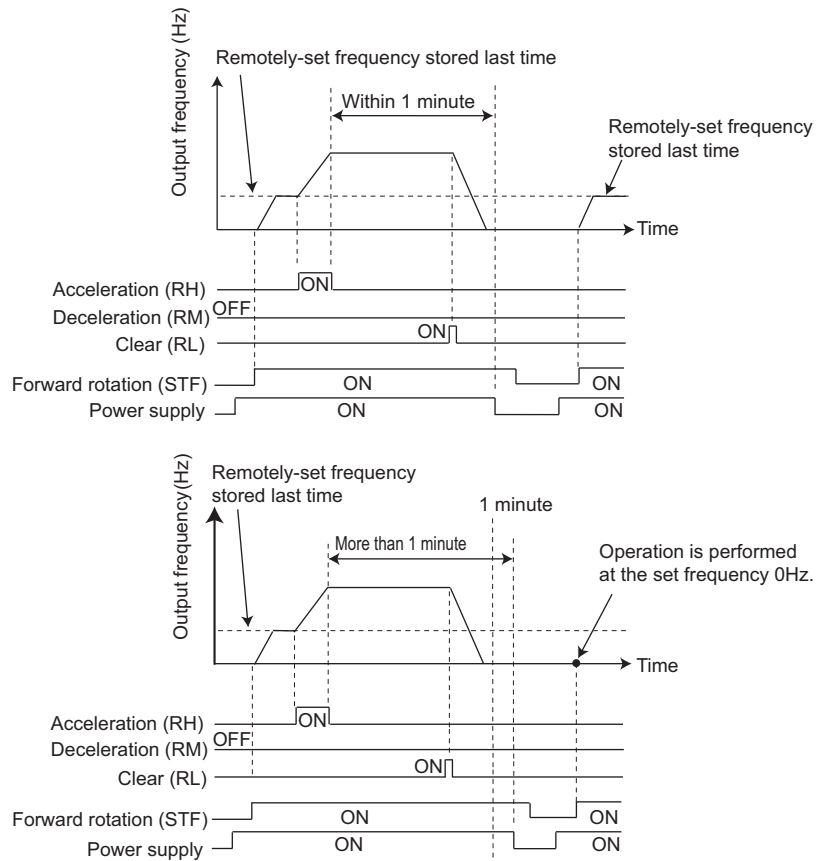

CAUTION

⚠ When selecting this function, re-set the maximum frequency according to the machine.



Parameters referred to

Pr: 1 Maximum frequency, Pr: 18 High speed maximum frequency Refer to page 124

Pr: 7 Acceleration time, Pr: 8 Deceleration time, Pr: 44 Second acceleration/deceleration time, Pr: 45 Second deceleration time Refer to page 135

Pr: 180 to Pr: 184 (input terminal function selection) Refer to page 163

5.10 Setting of acceleration/deceleration time and acceleration/ deceleration pattern

Purpose	Parameter that should be Set		Refer to Page
Motor acceleration/deceleration time setting	Acceleration/deceleration times	Pr. 7, Pr. 8, Pr. 20, Pr. 21, Pr. 44, Pr. 45, Pr. 147	135
Starting frequency	Starting frequency and start-time hold	Pr. 13, Pr. 571	138
Set acceleration/deceleration pattern suitable for application	Acceleration/deceleration pattern	Pr. 29	139
Automatically set optimum acceleration/deceleration time.	Automatic acceleration/ deceleration	Pr. 61 to Pr. 63, Pr. 292	140

5.10.1 Setting of the acceleration and deceleration time (Pr. 7, Pr. 8, Pr. 20, Pr. 21, Pr. 44, Pr. 45, Pr. 147)

Used to set motor acceleration/deceleration time.

Set a larger value for a slower speed increase/decrease or a smaller value for a faster speed increase/decrease.

For the acceleration time at automatic restart after instantaneous power failure, refer to *Pr. 611 Acceleration time at a restart (page 180)*.

Parameter Number	Name	Initial Value		Setting Range	Description
7	Acceleration time	3.7K or lower	5s	0 to 3600/ 360s *2	Motor acceleration time.
		5.5K, 7.5K	10s		
		11K, 15K	15s		
8	Deceleration time	3.7K or lower	5s	0 to 3600/ 360s *2	Motor deceleration time.
		5.5K, 7.5K	10s		
		11K, 15K	15s		
20 *1	Acceleration/ deceleration reference frequency	60Hz		1 to 400Hz	Frequency that will be the basis of acceleration/deceleration time. As acceleration/deceleration time, set the frequency change time from stop to <i>Pr. 20</i> .
21 *1	Acceleration/ deceleration time increments	0		0	Increments: 0.1s Range: 0 to 3600s Increments and setting range of acceleration/ deceleration time setting can be changed.
				1	
44 *1	Second acceleration/ deceleration time	3.7K or lower	5s	0 to 3600/ 360s *2	Acceleration/deceleration time when the RT signal is ON.
		5.5K, 7.5K	10s		
		11K, 15K	15s		
45 *1	Second deceleration time	9999		0 to 3600/ 360s *2	Deceleration time when the RT signal is ON.
				9999	Acceleration time = deceleration time
147 *1	Acceleration/ deceleration time switching frequency	9999		0 to 400Hz	Frequency when automatically switching to the acceleration/deceleration time of <i>Pr. 44</i> and <i>Pr. 45</i> .
				9999	No function

*1 The above parameters can be set when *Pr. 160 User group read selection* = "0". (Refer to page 197)

*2 Depends on the *Pr. 21 Acceleration/deceleration time increments* setting. The initial value for the setting range is "0 to 3600s" and the setting increments is "0.1s".

(1) Acceleration time setting (Pr. 7, Pr. 20)

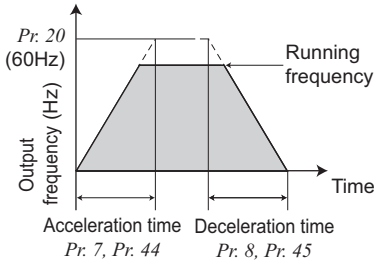

- Use Pr. 7 Acceleration time to set the acceleration time required to reach Pr. 20 Acceleration/deceleration reference frequency from 0Hz.
- Set the acceleration time according to the following formula.

$$\text{Acceleration time setting} = \frac{\text{Pr. 20}}{\text{Maximum operating frequency} - \text{Pr. 13}} \times \text{Acceleration time from a stop to the maximum operating frequency}$$

Example) How to find the setting value for Pr. 7 when increasing the output frequency to the maximum frequency of 50Hz in 10s with Pr. 20 = "60Hz (initial setting)" and Pr. 13 = "0.5Hz (initial setting)".

$$\text{Pr. 7} = \frac{60\text{Hz}}{50\text{Hz} - 0.5\text{Hz}} \times 10\text{s} \doteq 12.1\text{s}$$

(2) Deceleration time setting (Pr. 8, Pr. 20)

- Use Pr. 8 Deceleration time to set the deceleration time required to reach 0Hz from Pr. 20 Acceleration/deceleration reference frequency.
- Set the deceleration time according to the following expression.

$$\text{Deceleration time setting} = \frac{\text{Pr. 20}}{\text{Maximum operating frequency} - \text{Pr. 10}} \times \text{Deceleration time from the maximum operating frequency to a stop}$$

Example) How to find the setting value for Pr. 8 when decreasing the output frequency from the maximum frequency of 50Hz in 10s with Pr. 20 = "120Hz" and Pr. 10 = "3Hz (initial setting)".

$$\text{Pr. 8} = \frac{120\text{Hz}}{50\text{Hz} - 3\text{Hz}} \times 10\text{s} \doteq 25.5\text{s}$$

(3) Change the setting range and increments of the acceleration/deceleration time (Pr. 21)

- Use Pr. 21 to set the acceleration/deceleration time and minimum setting range.
 Value "0" (initial value)0 to 3600s (minimum setting increments: 0.1s)
 Value "1"0 to 360s (minimum setting increments: 0.01s)



NOTE

- Changing the Pr. 21 setting changes the acceleration/deceleration time setting (Pr. 7, Pr. 8, Pr. 16, Pr. 44, Pr. 45). (It does not influence the setting of Pr. 611 Acceleration time at a restart.)

<Example>

When Pr. 7 is set to "5.0s" at Pr. 21 setting of "0", and then Pr. 21 is changed to "1", the Pr. 7 setting automatically changes to "0.5s".

(4) Set two kinds of acceleration/deceleration times (RT signal, Pr. 44, Pr. 45, Pr. 147)

- Pr. 44 and Pr. 45 are valid when the RT signal is ON, or the output frequency reaches or exceeds the setting of Pr. 147.
- When "9999" is set to Pr. 45, the deceleration time becomes equal to the acceleration time (Pr. 44).
- For the RT signal, set "3" in any of Pr. 180 to Pr. 184 (input terminal function selection) to assign the function.
- Acceleration/deceleration time changes when the RT signal turns ON or the output frequency reaches the Pr.147 setting or higher.

Pr. 147 Setting	Acceleration/Deceleration Time	Description
9999 (initial value)	Pr. 7, Pr. 8	No automatic switching of the acceleration/deceleration time
0.00Hz	Pr. 44, Pr. 45	Second acceleration/deceleration time from a start
0.00Hz ≤ Pr. 147 ≤ Set frequency	Output frequency < Pr. 147: Pr. 7, Pr. 8 Pr. 147 ≤ Output frequency: Pr. 44, Pr. 45	Acceleration/deceleration time automatic switching *
Set frequency < Pr. 147	Pr. 7, Pr. 8	No automatic switching, since output frequency will not reach the switching frequency

* When the RT signal turns on, the acceleration/deceleration time switches to the second acceleration/deceleration time even when the output frequency is not reached to Pr. 147 setting.

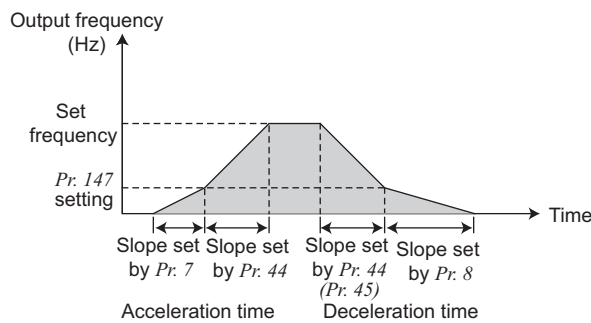

NOTE

- When the acceleration/deceleration pattern is S-pattern acceleration/deceleration A (refer to page 139), the acceleration/ deceleration time is the time required to reach Pr. 3 Base frequency .
- Acceleration/deceleration time formula when the set frequency is the base frequency or higher

$$t = \frac{4}{9} \times \frac{T}{(Pr. 3)^2} \times f^2 + \frac{5}{9} T$$

T: Acceleration/deceleration time setting (s)
f: Set frequency (Hz)

- Guideline for acceleration/deceleration time at the Pr. 3 Base frequency of 60Hz (0Hz to set frequency)

Frequency setting (Hz)	60	120	200	400
Acceleration/ deceleration time (s)				
5	5	12	27	102
15	15	35	82	305

- Changing the assignment of a virtual terminal of CC-Link communication may affect other functions. Set parameters after confirming the function of each virtual terminal.



REMARKS

- The RT signal acts as the second function selection signal and makes the other second functions valid. (Refer to page 165)
- When the Pr. 7, Pr. 8, Pr. 44 and Pr. 45 settings are 0.03s or less, the acceleration/deceleration time is 0.04s. At that time, set Pr. 20 to "120Hz" or less.
- Any value can be set to the acceleration/deceleration time but the actual motor acceleration/deceleration time cannot be made shorter than the shortest acceleration/deceleration time determined by the mechanical system J (moment of inertia) and motor torque.



Parameters referred to

- Pr. 3 Base frequency Refer to page 126
- Pr. 10 DC injection brake operation frequency Refer to page 154
- Pr. 29 Acceleration/deceleration pattern selection Refer to page 139
- Pr. 180 to Pr. 184 (input terminal function selection) Refer to page 163

5.10.2 Starting frequency and start-time hold function (Pr. 13, Pr. 571)

You can set the starting frequency and hold the set starting frequency for a certain period of time.
Set these functions when you need the starting torque or want to smooth motor drive at a start.

Parameter Number	Name	Initial Value	Setting Range	Description
13	Starting frequency	0.5Hz	0 to 60Hz	Frequency at start can be set in the range 0 to 60Hz. Starting frequency at which the start signal is turned ON.
571	Holding time at a start	9999	0.0 to 10.0s	Holding time of Pr. 13 Starting frequency.
			9999	Holding function at a start is invalid

The above parameters can be set when Pr. 160 User group read selection = "0". (Refer to page 197)

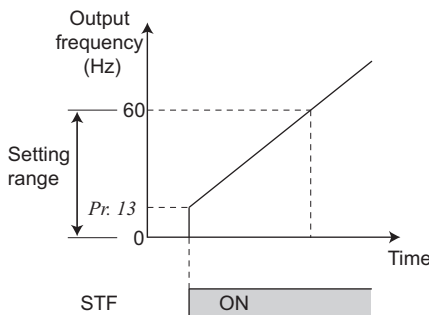

(1) Starting frequency setting (Pr. 13)

- Frequency at start can be set in the range 0 to 60Hz.
- You can set the starting frequency at which the start signal is turned ON.



NOTE

The inverter will not start if the frequency setting signal is less than the value set in Pr. 13.
For example, when 5Hz is set in Pr. 13, the motor will not start running until the frequency setting signal reaches 5Hz.

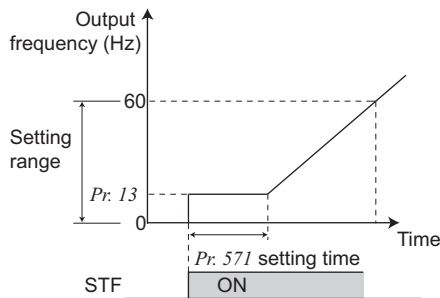

(2) Start-time hold function (Pr. 571)

- This function holds during the period set in Pr. 571 and the output frequency set in Pr. 13 Starting frequency.
- This function performs initial excitation to smooth the motor drive at a start.



REMARKS

When Pr. 13 = "0Hz", the starting frequency is held at 0.01Hz.



NOTE

- When the start signal was turned OFF during start-time hold, deceleration is started at that point.
- At switching between forward rotation and reverse rotation, the starting frequency is valid but the start-time hold function is invalid.



CAUTION



Note that when Pr. 13 is set to any value equal to or lower than Pr. 2 Minimum frequency, simply turning ON the start signal will run the motor at the preset frequency even if the command frequency is not input.



Parameters referred to

Pr. 2 Minimum frequency Refer to page 124

5.10.3 Acceleration/deceleration pattern (Pr. 29)

You can set the acceleration/deceleration pattern suitable for application.

Parameter Number	Name	Initial Value	Setting Range	Description
29	Acceleration/deceleration pattern selection	0	0	Linear acceleration/ deceleration
			1	S-pattern acceleration/deceleration A
			2	S-pattern acceleration/deceleration B

The above parameters can be set when Pr. 160 User group read selection = "0". (Refer to page 197)

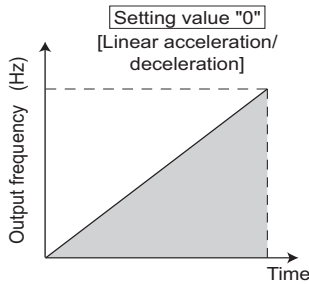

(1) Linear acceleration/deceleration (Pr. 29 = "0", initial value)

•For the inverter operation, the output frequency is made to change linearly (linear acceleration/deceleration) to prevent the motor and inverter from excessive stress to reach the set frequency during acceleration, deceleration, etc. when frequency changes. Linear acceleration/deceleration has a uniform frequency/time slope.

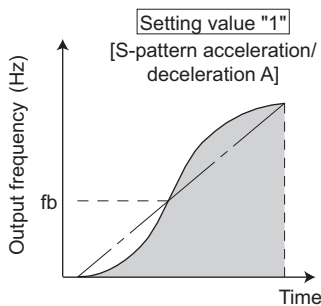

(2) S-pattern acceleration/deceleration A (Pr. 29 = "1")

•For machine tool spindle applications, etc.
Used when acceleration/deceleration must be made in a short time to a high-speed range of not lower than the base frequency.
In this acceleration/deceleration pattern, Pr. 3 Base frequency (fb) is the inflection point of the S pattern and you can set the acceleration/deceleration time appropriate for motor torque reduction in a constant-power operation range of base frequency (fb) or higher.



NOTE

• As the acceleration/deceleration time of S-pattern acceleration/deceleration A, set the time taken until Pr. 3 Base frequency is reached, not Pr. 20 Acceleration/deceleration reference frequency.

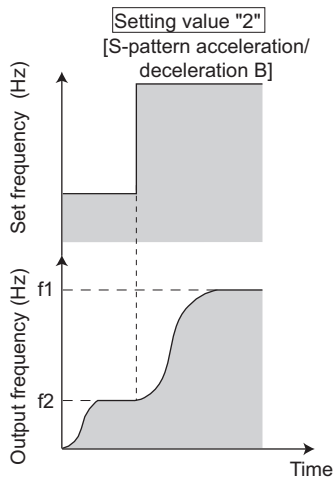

(3) S-pattern acceleration/deceleration B (Pr. 29 = "2")

•For prevention of load shifting in conveyor and other applications.
Since acceleration/deceleration is always made in an S shape from current frequency (f2) to target frequency (f1), this function eases shock produced at acceleration/deceleration and is effective for load collapse prevention, etc.



Parameters referred to

Pr. 3 Base frequency Refer to page 126

Pr. 7 Acceleration time, Pr. 8 Deceleration time, Pr. 20 Acceleration/deceleration reference frequency Refer to page 135

5.10.4 Shortest acceleration/deceleration (automatic acceleration/deceleration) (Pr. 61 to Pr. 63, Pr. 292, Pr. 293)

The inverter operates in the same conditions as when appropriate values are set in each parameter even if acceleration/deceleration time and V/F pattern are not set. This function is useful when you just want to operate, etc. without fine parameter setting.

Parameter Number	Name	Initial Value	Setting Range	Description
61	Reference current	9999	0 to 500A	Set the reference current during shortest acceleration/deceleration.
			9999	Rated inverter output current value is reference
62	Reference value at acceleration	9999	0 to 200%	Set the limit value during shortest acceleration.
			9999	150% is a limit value
63	Reference value at deceleration	9999	0 to 200%	Set the limit value during shortest deceleration.
			9999	150% is a limit value
292	Automatic acceleration/ deceleration	0	0	Normal mode
			1	Shortest acceleration/deceleration (without brake)
			11	Shortest acceleration/deceleration (with brake)
			7, 8	Brake sequence mode 1, 2 (Refer to page 160)
293	Acceleration/deceleration separate selection	0	0	Both acceleration and deceleration are made in the shortest acceleration/deceleration mode
			1	Only acceleration is made in the shortest acceleration/deceleration mode
			2	Only deceleration is made in the shortest acceleration/deceleration mode

The above parameters can be set when Pr. 160 User group read selection = "0". (Refer to page 197)

(1) Shortest acceleration/deceleration mode (Pr. 292 = "1, 11", Pr. 293)

- Set when you want to accelerate/decelerate the motor for the shortest time. It is desired to make acceleration/deceleration in a shorter time for a machine tool etc. but the design values of machine constants are unknown.
- Acceleration/deceleration speed is automatically adjusted at a start of acceleration/deceleration from the value of the setting value of Pr. 7 Acceleration time and Pr. 8 Deceleration time so that acceleration/deceleration is made with the maximum torque the inverter can output. (The setting values of Pr. 7 and Pr. 8 are not changed.)
- Either acceleration or deceleration can be made in the shortest time using Pr. 293 Acceleration/deceleration separate selection. When the setting value is "0" (initial value), both acceleration and deceleration can be made in the shortest time.
- Set "11" when an optional MRS type, MYS type brake resistor, high-duty brake resistor or brake unit is connected. Deceleration time can be further shortened.
- When the shortest/acceleration mode is selected, the stall prevention operation level during acceleration/deceleration from the value of becomes 150% (adjustable using Pr. 61 to Pr. 63). Setting of Pr. 22 Stall prevention operation level is used only during a constant speed operation.
- It is inappropriate to use for the following applications.
 - a) Machine with a large inertia such as a fan (more than 10 times). Since stall prevention operation will be activated for a long time, this type of machine may be brought to an alarm stop due to motor overloading, etc.
 - b) To perform operation with a constant acceleration/deceleration time.

REMARKS

- Even if automatic acceleration/deceleration mode has been selected, inputting the RT signal (second function selection) during an inverter stop will switch to the normal operation and give priority to second function selection. Note that RT signal input is invalid even if RT signal are input during operation in automatic acceleration/deceleration mode.
- Since acceleration/deceleration is made with the stall prevention operation being activated, the acceleration/deceleration speed always varies according to the load conditions.
- Note that when proper values are set in Pr. 7 and Pr. 8, acceleration/deceleration time may be shorter than selecting shortest acceleration/deceleration mode.

(2) Adjustment of shortest acceleration/deceleration mode (Pr. 61 to Pr. 63)

•By setting the adjustment parameters Pr. 61 and Pr. 63, the application range can be made wider.

Parameter Number	Name	Setting Range	Description
61	Reference current	0 to 500A	For example, when the motor and inverter are different in capacity, set the rated motor current value. Set reference current (A) of the stall prevention operation level during acceleration/deceleration.
		9999 (initial value)	The rated inverter current is defined as reference.
62	Reference value at acceleration	0 to 200%	Set when it is desired to change the reference level of acceleration and deceleration. Set the stall prevention operation level (ratio to the current value of Pr. 61) during acceleration/deceleration.
63	Reference value at deceleration	9999 (initial value)	Stall prevention operation level is 150% for the shortest acceleration/ deceleration.





REMARKS

- Since the Pr. 61 to Pr. 63 settings automatically return to the initial value (9999) if the Pr. 292 setting is changed, set Pr. 292 first when you need to set Pr. 61 to Pr. 63.



Parameters referred to

- Pr. 0 Torque boost  Refer to page 113
- Pr. 7 Acceleration time, Pr. 8 Deceleration time  Refer to page 135
- Pr. 22 Stall prevention operation level  Refer to page 120

5.11 Selection and protection of a motor

Purpose	Parameter that should be Set		Refer to Page
Motor protection from overheat	Electronic thermal O/L relay	Pr. 9, Pr. 51	142
Use the constant-torque motor	Applied motor	Pr. 71	144
The motor performance can be maximized for operation in magnetic flux vector control method.	Offline auto tuning	Pr. 71, Pr. 80 to Pr. 84, Pr. 90 to Pr. 94, Pr. 96, Pr. 859	146

5.11.1 Motor overheat protection (Electronic thermal O/L relay) (Pr. 9, Pr. 51)

Set the current of the electronic thermal relay function to protect the motor from overheat. This feature provides the optimum protective characteristics, including reduced motor cooling capability, at low speed.

Parameter Number	Name	Initial Value	Setting Range	Description
9	Electronic thermal O/L relay	Inverter rated current *1	0 to 500A	Set the rated motor current.
51*2	Second electronic thermal O/L relay *3	9999	0 to 500A	Valid when the RT signal is ON. Set the rated motor current.
			9999	Second electronic thermal O/L relay invalid

*1 The initial value of the 0.75K or lower is set to 85% of the rated inverter current.

*2 The above parameters can be set when Pr. 160 User group read selection = "0". (Refer to page 197)

*3 When parameter is read using the FR-PU04, a parameter name different from an actual parameter is displayed.

(1) Electronic thermal O/L relay (Pr. 9)

Electronic thermal O/L relay operation characteristic

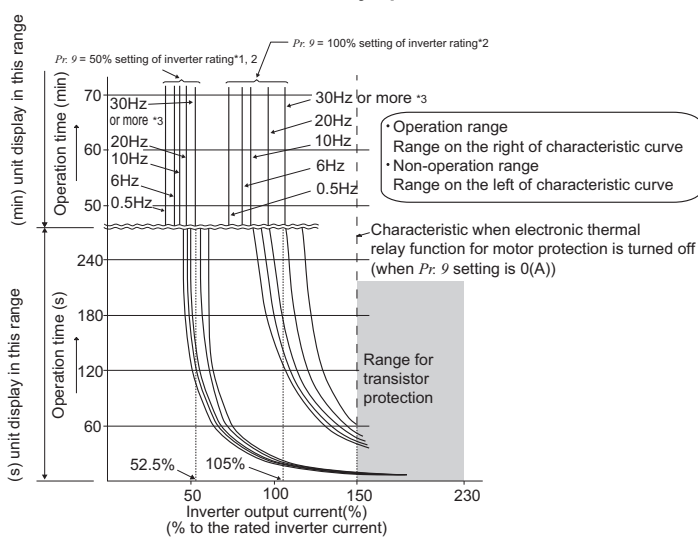

This function detects the overload (overheat) of the motor and trips. (The operation characteristic is shown on the left)

- Set the rated current (A) of the motor in Pr. 9. (If the motor has both 50Hz and 60Hz rating and the Pr. 3 Base frequency is set to 60Hz, set the 1.1 times of the 60Hz rated motor current.)
- Set "0" in Pr. 9 when you do not want to operate the electronic thermal O/L relay, e.g. when using an external thermal relay with the motor. (Note that the output transistor protection of the inverter functions (E.THT).)
- When using a Mitsubishi constant-torque motor
 - 1) Set "1" or "13 to 16", "50", "53", "54" in any of Pr. 71. (This provides a 100% continuous torque characteristic in the low-speed range.
 - 2) Set the rated current of the motor in Pr. 9.

*1 When 50% of the inverter rated output current (current value) is set to Pr. 9

*2 The % value denotes the percentage to the inverter rated output current. It is not the percentage to the motor rated current.

*3 When you set the electronic thermal O/L relay dedicated to the Mitsubishi constant-torque motor, this characteristic curve applies to operation at 6Hz or higher.



NOTE

- Fault by electronic thermal relay function is reset by inverter power reset and reset signal input. Avoid unnecessary reset and power-OFF.
- When multiple motors are operated by a single inverter, protection cannot be provided by the electronic thermal function. Install an external thermal relay to each motor.
- When the difference between the inverter and motor capacities is large and the setting is small, the protective characteristics of the electronic thermal relay function will be deteriorated. In this case, use an external thermal relay.
- A special motor cannot be protected by the electronic thermal relay function.
- The operation time of the transistor protection thermal shortens when the Pr. 72 PWM frequency selection setting increases.

(2) Set two different electronic thermal O/L relays (Pr. 51)

Use this function when running two motors of different rated currents individually by a single inverter. (When running two motors together, use external thermal relays.)

- Set the rated current of the second motor to Pr. 51.
- When the RT signal is ON, thermal protection is provided based on the Pr. 51 setting.
- To input the RT signal to a virtual terminal of CC-Link communication, set "3" in one of Pr. 180 to Pr. 184 (input terminal function selection) to assign the function to the terminal.

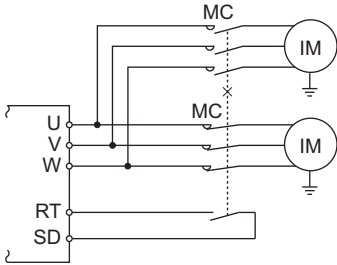

Pr. 450 Second applied motor	Pr. 9 Electronic thermal O/L relay	Pr.51 Second electronic thermal O/L relay	RT = OFF		RT = ON	
			First motor	Second motor	First motor	Second motor
9999	0	9999	x	x	x	x
		0	x	x	x	x
		0.01 to 500	x	Δ	x	○
9999	Other than 0	9999	○	x	○	x
		0	○	x	Δ	x
		0.01 to 500	○	Δ	Δ	○
Other than 9999	0	9999	x	x	x	x
		0	x	x	x	x
		0.01 to 500	x	Δ	x	○
Other than 9999	Other than 0	9999	○	Δ	Δ	○
		0	○	x	Δ	x
		0.01 to 500	○	Δ	Δ	○

○... Output current value is used to perform integration processing.
 Δ... Output current is assumed as 0A to perform integration processing. (cooling processing)
 x... Electronic thermal relay function is not activated.

REMARKS

- The RT signal acts as the second function selection signal and makes the other second functions valid. (Refer to page 165)

(3) Electronic thermal relay function prealarm (TH) and alarm signal (THP signal)

100%: Electronic thermal O/L relay alarm operation value

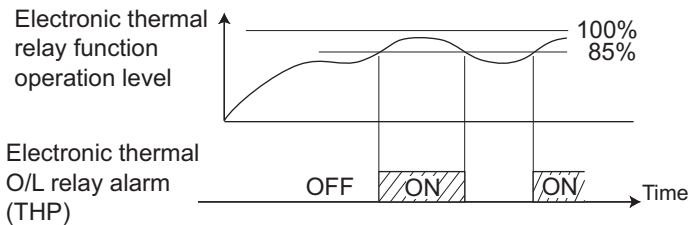

- The alarm signal (THP) is output and electronic thermal relay function prealarm (TH) is displayed when the electronic thermal O/L relay cumulative value reaches 85% of the level set in Pr. 9 or Pr. 51. If it reaches 100% of the Pr. 9 Electronic thermal O/L relay setting, a motor overload trip (E.THM/E.THT) occurs.
- The inverter does not trip even when the alarm signal (THP) is output.
- To assign the THP signal to the terminal Y0 or a virtual terminal of CC-Link communication, set "8 (positive logic) or 108 (negative logic)" in one of Pr.190 to Pr.192 and Pr.313 to Pr.315 (output terminal function selection).

NOTE

- Changing the assignment of the terminal Y0 or a virtual terminal of CC-Link communication with one of Pr. 190 to Pr. 192, and Pr. 313 to Pr. 315 (output terminal function selection) may affect other functions. Set parameters after confirming the function of the terminal Y0 and virtual terminals.



Parameters referred to

- Pr. 71 Applied motor Refer to page 144
- Pr. 72 PWM frequency selection Refer to page 192
- Pr. 180 to Pr. 184 (input terminal function selection) Refer to page 163
- Pr. 190 to Pr. 192, Pr. 313 to Pr. 315 (output terminal function selection) Refer to page 167

5.11.2 Applied motor (Pr. 71, Pr. 450)

Setting of the used motor selects the thermal characteristic appropriate for the motor.

Setting is required to use a constant-torque motor. Thermal characteristic of the electronic thermal relay function suitable for the motor is set.

When General-purpose magnetic flux vector or Advanced magnetic flux vector control is selected, the motor constants (SF-JR, SF-HR, SF-JRCA, SF-HRCA, etc.) necessary for control are selected as well.

Parameter Number	Name	Initial Value	Setting Range	Description
71	Applied motor	0	0, 1, 3 to 6, 13 to 16, 23, 24, 40, 43, 44, 50, 53, 54	Selecting the standard motor or constant-torque motor sets the corresponding motor thermal characteristic.
450	Second applied motor	9999	0, 1	Set when using the second motor.
			9999	Second motor is invalid (thermal characteristic of the first motor (Pr. 71))

The above parameters can be set when Pr. 160 User group read selection = "0". (Refer to page 197)

(1) Set the motor to be used

Refer to the following list and set this parameter according to the motor used.

Pr. 71 (Pr. 450) Setting		Thermal Characteristic of the Electronic Thermal Relay Function	Motor (O: Used motor)	
Pr. 71	Pr. 450		Standard (SF-JR, etc.)	Constant-torque (SF-JRCA, etc.)
0 (Pr. 71 initial value)	—	Thermal characteristics of a standard motor	○	
1	—	Thermal characteristics of the Mitsubishi constant-torque motor		○
40	—	Thermal characteristic of Mitsubishi high efficiency motor (SF-HR)	○ *1	
50	—	Thermal characteristic of Mitsubishi constant-torque motor (SF-HRCA)		○ *2
3	—	Standard motor	Select "Offline auto tuning setting"	
13	—	Constant-torque motor		
23	—	Mitsubishi standard motor (SF-JR 4P 1.5kW or less)		
43	—	Mitsubishi high efficiency motor (SF-HR)		
53	—	Mitsubishi constant-torque motor (SF-HRCA)		
4	—	Standard motor	Auto tuning data can be read, changed, and set.	
14	—	Constant-torque motor		
24	—	Mitsubishi standard motor (SF-JR 4P 1.5kW or less)		
44	—	Mitsubishi high efficiency motor (SF-HR)		
54	—	Mitsubishi constant-torque motor (SF-HRCA)		
5	—	Standard motor	Star connection Direct input of motor constants is enabled	
15	—	Constant-torque motor		
6	—	Standard motor		
16	—	Constant-torque motor		○
—	9999 (initial value)	Without second applied motor		

*1 Motor constants of Mitsubishi high efficiency motor SF-HR.

*2 Motor constants of Mitsubishi constant-torque motor SF-HRCA.

REMARKS

- When performing offline auto tuning, set any of "3, 13, 23, 43, 53" in Pr. 71. (Refer to page 146 for offline auto tuning.)
- For the 5.5K and 7.5K, the Pr. 0 Torque boost and Pr. 12 DC injection brake operation voltage settings are automatically changed according to the Pr. 71 setting as follows.

Automatic Change Parameter	Standard Motor Setting *1	Constant-torque Motor Setting *2
Pr. 0	3%	2%
Pr. 12	4%	2%

*1 Pr. 71 setting: 0, 3 to 6, 23, 24, 40, 43, 44

*2 Pr. 71 setting: 1, 13 to 16, 50, 53, 54

NOTE

- Set the electronic thermal relay function to the thermal characteristic for the constant-torque motor when using a geared motor (GM-S, GM-D, GM-SY, GM-HY2 series) to perform Advanced magnetic flux vector control or General-purpose magnetic-flux vector control.

(2) Use two motors (Pr. 450)

- Set Pr. 450 *Second applied motor* to use two different motors with one inverter.
- When "9999" (initial value) is set, no function is selected.
- When a value other than 9999 is set in Pr. 450, the second motor is valid when the RT signal turns ON.
- For the RT signal, set "3" in any of Pr. 180 to Pr. 184 (*input terminal function selection*) to assign the function.



REMARKS

- The RT signal acts as the second function selection signal and makes the other second functions valid. (Refer to page 165)



NOTE

- Changing the assignment of a virtual terminal of CC-Link communication with Pr. 180 to Pr. 184 (*input terminal function selection*) may affect other functions. Set parameters after confirming the function of each virtual terminal.



CAUTION



Set this parameter correctly according to the motor used.

Incorrect setting may cause the motor to overheat and burn.





Parameters referred to

Pr. 0 Torque boost  Refer to page 113

Pr. 12 DC injection brake operation voltage  Refer to page 154

Pr. 80 Motor capacity, Pr. 81 Number of motor poles  Refer to page 146

Pr. 82 to Pr. 84, Pr. 90 to Pr. 94 (motor constants), Pr. 96 Auto tuning setting/status  Refer to page 146

Pr. 800 Control method selection  Refer to page 112

5.11.3 Exhibiting the best performance for the motor (offline auto tuning)

(Pr. 71, Pr. 80 to Pr. 84, Pr. 90 to Pr. 94, Pr. 96, Pr. 859)

The motor performance can be maximized with offline auto tuning.

●What is offline auto tuning?

When performing Advanced magnetic flux vector control or General-purpose magnetic flux vector control, the motor can be run with the optimum operating characteristics by automatically measuring the motor constants (offline auto tuning) even when each motor constants differs, other manufacturer's motor is used, or the wiring length is long (30m or more as a reference).

Parameter Number	Name	Initial Value		Setting Range	Description
71	Applied motor	0		0, 1, 3 to 6, 13 to 16, 23, 24, 40, 43, 44, 50, 53, 54	By selecting a standard motor or constant-torque motor, thermal characteristic and motor constants of each motor are set.
80	Motor capacity	9999		0.1 to 15kW	Applied motor capacity.
		9999		9999	V/F control
81	Number of motor poles	9999		2, 4, 6, 8, 10	Number of motor poles.
		9999		9999	V/F control
82	Motor excitation current	9999		0 to 500A	Tuning data (The value measured by offline auto tuning is automatically set.)
		9999		9999	Uses the Mitsubishi motor (SF-JR, SF-HR, SF-JRCA, SF-HRCA) constants.
83	Rated motor voltage	200V class	200V	0 to 1000V	Rated motor voltage (V).
		400V class	400V		
84	Rated motor frequency	60Hz		10 to 120Hz	Rated motor frequency (Hz).
90	Motor constant (R1)	9999		0 to 50Ω, 9999	Tuning data
91	Motor constant (R2)	9999		0 to 50Ω, 9999	(The value measured by offline auto tuning is automatically set.)
92	Motor constant (L1)	9999		0 to 1000mH, 9999	
93	Motor constant (L2)	9999		0 to 1000mH, 9999	9999: Uses the Mitsubishi motor (SF-JR, SF-HR, SF-JRCA, SF-HRCA) constants.
94	Motor constant (X)	9999		0 to 100%, 9999	
96	Auto tuning setting/status	0		0	Offline auto tuning is not performed
		0		1	For Advanced magnetic flux vector control Offline auto tuning is performed without motor running (all motor constants).
		0		11	For General-purpose magnetic flux vector control Offline auto tuning is performed without motor running. (motor constant (R1) only)
		0		21	Offline auto tuning for V/F control (automatic restart after instantaneous power failure (with frequency search)) (Refer to page 182)
859	Torque current	9999		0 to 500A	Tuning data (The value measured by offline auto tuning is automatically set.)
		9999		9999	Uses the Mitsubishi motor (SF-JR, SF-HR, SF-JRCA, SF-HRCA) constants.

The above parameters can be set when Pr. 160 User group read selection = "0".(Refer to page 197)

- The setting range and increments of Pr. 82, Pr. 90 to Pr. 94 and Pr. 859 changes according to the setting value of Pr. 71 and Pr. 96.

Applied Motor		Internal Stored Value *1		Direct Input Value *2		Auto Tuning Measured Value *3	
Parameter Number	Function Name	Setting Range	Setting Increments	Setting Range	Setting Increments	Setting Range	Setting Increments
82	Motor excitation current	0 to 500A, 9999	0.01A	0 to 500A, 9999	0.01A	0 to ****, 9999	1
90	Motor constant (R1)	0 to 50Ω, 9999	0.001Ω	0 to 50Ω, 9999	0.001Ω	0 to ****, 9999	1
91	Motor constant (R2)	0 to 50Ω, 9999	0.001Ω	0 to 50Ω, 9999	0.001Ω	0 to ****, 9999	1
92	Motor constant (L1)	0 to 1000mH, 9999	0.1mH	0 to 50Ω, 9999	0.001Ω	0 to ****, 9999	1
93	Motor constant (L2)	0 to 1000mH, 9999	0.1mH	0 to 50Ω, 9999	0.001Ω	0 to ****, 9999	1
94	Motor constant (X)	0 to 100%, 9999	0.1%	0 to 500Ω, 9999	0.01Ω	0 to ****, 9999	1
859	Torque current	0 to 500A, 9999	0.01A	0 to 500A, 9999	0.01A	0 to ****, 9999	1

*1 When Pr. 71 = "0, 1, 40 or 50", or setting value of Pr. 96 read after performing offline auto tuning is not "3, 13, 23".

*2 When Pr. 71 = "5, 6, 15, or 16"

*3 When Pr. 71 = "3, 13, 23, 43 or 53" and setting value of Pr. 96 read after performing offline auto tuning is "3, 13, 23". Or when Pr. 71 = "4, 14, 24, 44 or 54".



POINT

- This function is valid only when a value other than "9999" is set in Pr. 80 and Pr. 81 and Advanced magnetic flux vector control or General-purpose magnetic flux vector control is selected.
- Even when motors (other manufacturer's motor, SF-JRC, etc.) other than Mitsubishi standard motor (SF-JR 0.2kW or more), high efficiency motor (SF-HR 0.2kW or more), and Mitsubishi constant-torque motor (SF-JRCA four-pole, SF-HRCA 0.2kW to 15kW) are used or the wiring length is long (30m or more as a reference), using the offline auto tuning function runs the motor with the optimum operating characteristics.
- Tuning is enabled even when a load is connected to the motor.
As the motor may run slightly, fix the motor securely with a mechanical brake or make sure that there will be no problem in safety if the motor runs (caution is required especially in elevator). Note that tuning performance is unaffected even if the motor runs slightly.
- Reading/writing/copy of motor constants tuned by offline auto tuning are enabled.
- The offline auto tuning status can be monitored with the operation panel and PU (FR-PU04/FR-PU07).
- Do not connect a surge voltage suppression filter (FR-ASF-H/FR-BMF-H) between the inverter and motor.

(1) Before performing offline auto tuning

Check the following before performing offline auto tuning.

- Make sure Advanced magnetic flux vector control or General-purpose magnetic flux vector control (Pr. 80, Pr. 81) is selected. (Tuning can be performed even under V/F control selected by turning ON X18.)
- A motor should be connected. Note that the motor should be at a stop at a tuning start.
- The motor capacity should be equal to or one rank lower than the inverter capacity. (note that the capacity should be 0.1kW or more)
- A high-slip motor, high-speed motor and special motor cannot be tuned. (The maximum frequency is 120Hz.)
- As the motor may run slightly, fix the motor securely with a mechanical brake or make sure that there will be no problem in safety if the motor runs (caution is required especially in elevator). Note that tuning performance is unaffected even if the motor runs slightly.
- Offline auto tuning will not be performed properly if it is performed with a surge voltage suppression filter (FR-ASF-H/FR-BMF-H) connected between the inverter and motor. Remove it before starting tuning.

(2) Setting

- 1) Select Advanced magnetic flux vector control (*Refer to page 114*) or General-purpose magnetic flux vector control (*Refer to page 117*).
- 2) Set "1" or "11" in *Pr. 96 Auto tuning setting/status*.
 - When the setting is "1" Tune all motor constants without running the motor.
 When performing Advanced magnetic flux vector control, set "1" to perform tuning.
 It takes approximately 25 to 75s* until tuning is completed.
 (Excitation noise is produced during tuning.)
 *Tuning time differs according to the inverter capacity and motor type.
 - When the setting is "11" Tune motor constants (R1) only without running the motor.
 When performing General-purpose magnetic flux vector control, set "11" to perform tuning.
 It takes approximately 9s until tuning is completed.
- 3) Set the rated motor current (initial value is rated inverter current) in *Pr. 9 Electronic thermal O/L relay*. (*Refer to page 142*)
- 4) Set the rated voltage of motor (initial value is 200V/400V) in *Pr. 83 Rated motor voltage* and rated motor frequency (initial value is 60Hz) in *Pr. 84 Rated motor frequency*.
 (For a Japanese standard motor, etc. which has both 50Hz and 60Hz rated values, use it with an initial value (200V/60Hz or 400V/60Hz).
- 5) Set *Pr. 71 Applied motor* according to the motor used.

Motor		Pr. 71 Setting *1
Mitsubishi standard motor Mitsubishi high efficiency motor	SF-JR	3
	SF-JR 4P 1.5kW or less	23
	SF-HR	43
	Others	3
Mitsubishi constant-torque motor	SF-JRCA 4P	13
	SF-HRCA	53
	Others (SF-JRC, etc.)	13
Other manufacturer's standard motor	—	3
Other manufacturer's constant-torque motor	—	13

*1 Refer to page 144, for other settings of *Pr. 71*.

(3) Execution of tuning



POINT

Before performing tuning, check the monitor display of the operation panel if the inverter is in the status for tuning. (Refer to 2) below.) When the start command is turned ON under V/F control, the motor starts.







- 1) In the PU operation mode, press  on the operation panel. In the Network operation mode, turn ON the start command via CC-Link communication. Tuning will start.



NOTE

- To end the tuning forcibly, input the MRS signal, command the inverter reset via CC-Link communication, or press  on the operation panel. (Turning the start signal (STF signal or STR signal) OFF also ends tuning.)
- During offline auto tuning, only the following I/O signals are valid: (initial value)
 - Input signal MRS, STF, STR
 - Output signal RUN, ALM
- Since the RUN signal turns ON when tuning is started, caution is required especially when a sequence which releases a mechanical brake by the RUN signal has been designed.
- When executing offline auto tuning, input the run command after switching on the main circuit power (R/L1, S/L2, T/L3) of the inverter.
- Do not perform ON/OFF switching of the second function selection signal (RT) during execution of offline auto tuning. Auto tuning is not executed properly.

- 2) Monitor is displayed on the operation panel during tuning as below.

	Operation Panel Indication	
Pr. 96 setting	1	11
(1) Setting		
(2) Tuning in progress		
(3) Normal end		
(4) Error end (when inverter protective function operation is activated)		



REMARKS

- Reference: Offline auto tuning time (when the initial value is set)

Offline Auto Tuning Setting	Time
Tune all motor constants (Pr. 96 = "1")	Approximately 25 to 75s (Tuning time differs according to the inverter capacity and motor type.)
Tune motor constants (R1) only (Pr. 96 = "11")	Approximately 9s

- The set frequency monitor displayed during the offline auto tuning is 0Hz.

- 3) When offline auto tuning ends, press  on the operation panel during PU operation. In the Network operation mode, turn OFF the start command via CC-Link communication. This operation resets the offline auto tuning and returns the operation panel monitor display to the normal display. (Without this operation, next operation cannot be started.)

REMARKS

- Do not change the *Pr. 96* setting after completion of tuning (3 or 13).
If the *Pr. 96* setting is changed, tuning data is invalid.
If the *Pr. 96* setting is changed, tuning must be performed again.
- 4) If offline auto tuning ended in error (see the table below), motor constants are not set. Perform an inverter reset and restart tuning.

Error Display	Error Cause	Remedy
8	Forced end	Set "1" or "11" in <i>Pr. 96</i> and perform tuning again.
9	Inverter protective function operation	Make setting again.
91	Current limit (stall prevention) function was activated.	Set "1" in <i>Pr. 156</i> .
92	Converter output voltage reached 75% of rated value.	Check for fluctuation of power supply voltage.
93	Calculation error A motor is not connected.	Check the motor wiring and make setting again. Set the rated current of the motor in <i>Pr. 9</i> .

- 5) When tuning is ended forcibly by pressing  or turning OFF the start signal (STF or STR) during tuning, offline auto tuning does not end properly. (The motor constants have not been set.) Perform an inverter reset and restart tuning.
- 6) After the tuning completes, set *Pr. 9 Electronic thermal O/L relay* again for the motor with the rated power supply of 200/220V(400/440V) 60Hz. Set the rated motor current multiplied by 1.1 in *Pr. 9*.

NOTE

- The motor constants measured once in the offline auto tuning are stored as parameters and their data are held until the offline auto tuning is performed again.
- An instantaneous power failure occurring during tuning will result in a tuning error. After power is restored, the inverter goes into the normal operation mode. Therefore, when STF (STR) signal is ON, the motor runs in the forward (reverse) rotation.
- Any alarm occurring during tuning is handled as in the ordinary mode. Note that if a fault retry has been set, retry is ignored.

CAUTION

 As the motor may run slightly during offline auto tuning, fix the motor securely with a mechanical brake or make sure that there will be no problem in safety if the motor runs. Note that if the motor runs slightly, tuning performance is unaffected.

(4) Utilizing or changing offline auto tuning data for use

The data measured in the offline auto tuning can be read and utilized or changed.

<Operating procedure>

1) Set *Pr. 71* according to the motor used.

Motor		<i>Pr. 71</i> Setting *1
Mitsubishi standard motor	SF-JR	4
	SF-JR 4P 1.5kW or less	24
	SF-HR	44
Mitsubishi high efficiency motor	SF-HR	4
	Others	4
Mitsubishi constant-torque motor	SF-JRCA 4P	14
	SF-HRCA	54
	Others (SF-JRC, etc.)	14
Other manufacturer's standard motor	-	4
Other manufacturer's constant-torque motor	-	14

*1 For other settings of *Pr.71*, refer to page 144.

2) In the parameter setting mode, read the following parameters and set desired values.

Parameter Number	Name	Setting Range	Setting Increments	Initial Value
82	Motor excitation current	0 to ****, 9999	1	9999
90	Motor constant (R1)	0 to ****, 9999	1	9999
91	Motor constant (R2)	0 to ****, 9999	1	9999
92	Motor constant (L1)	0 to ****, 9999	1	9999
93	Motor constant (L2)	0 to ****, 9999	1	9999
94	Motor constant (X)	0 to ****, 9999	1	9999
859	Torque current	0 to ****, 9999	1	9999

 **REMARKS**

- When "9999" is set in *Pr. 82*, *Pr. 90* to *Pr. 94*, *Pr. 859*, Mitsubishi motor (SF-JR, SF-HR, SF-JRCA, SF-HRCA) constants are used.
- As the motor constants measured in the offline auto tuning have been converted into internal data (****), refer to the following setting example when making setting:
 Setting example To slightly increase *Pr. 90* value (5%)
 When *Pr. 90* is displayed as "2516",
 set 2642, i.e. 2516 x 1.05=2641.8, in *Pr. 90*.
 (The value displayed has been converted into a value for internal use. Hence, simple addition of a given value to the displayed value has no significance.)

(5) Method to set the motor constants without using the offline auto tuning data

The Pr. 90 to Pr. 94 motor constants may either be entered in [Ω] or in [mH]. Before starting operation, confirm which motor constant unit is used.

- To enter the Pr. 90 to Pr. 94 motor constants in [Ω]

<Operating procedure>

1) Set Pr. 71 according to the motor used.

		Star Connection Motor	Delta Connection Motor
Setting	Standard motor	5	6
	Constant-torque motor	15	16

2) In the parameter setting mode, read the following parameters and set desired values.

I_q = torque current, I_{100} = rated current, I_0 = no load current

$$I_q = \sqrt{I_{100}^2 - I_0^2}$$

Parameter Number	Name	Setting Range	Setting Increments	Initial Value
82	Motor excitation current (no load current)	0 to 500A, 9999	0.01A	9999
90	Motor constant (r1)	0 to 50 Ω , 9999	0.001 Ω	9999
91	Motor constant (r2)	0 to 50 Ω , 9999	0.001 Ω	9999
92	Motor constant (x1)	0 to 50 Ω , 9999	0.001 Ω	9999
93	Motor constant (x2)	0 to 50 Ω , 9999	0.001 Ω	9999
94	Motor constant (xm)	0 to 500 Ω , 9999	0.01 Ω	9999
859	Torque current	0 to 500A, 9999	0.01A	9999

3) Refer to the following table and set Pr. 83 and Pr. 84.

Parameter Number	Name	Setting Range	Setting Increments	Initial Value	
83	Rated motor voltage	0 to 1000V	0.1V	200V class	200V
				400V class	400V
84	Rated motor frequency	10 to 120Hz	0.01Hz	60Hz	

REMARKS

- When "9999" is set in Pr. 82, Pr. 90 to Pr. 94, Pr. 859, Mitsubishi motor (SF-JR, SF-HR, SF-JRCA, SF-HRCA) constants are used.

NOTE

- If "star connection" is mistaken for "delta connection" or vice versa during setting of Pr. 71, Advanced magnetic flux vector control and General-purpose magnetic flux vector control cannot be exercised properly.

● To enter the Pr. 90 to Pr. 94 motor constants in [mH]

<Operating procedure>

1) Set Pr. 71 according to the motor used.

Motor		Pr. 71 Setting *1
Mitsubishi standard motor	SF-JR	0
Mitsubishi high efficiency motor	SF-HR	40
Mitsubishi constant-torque motor	SF-JRCA 4P	1
	SF-HRCA	50

*1 For other settings of Pr. 71, refer to page 144.

2) In the parameter setting mode, read the following parameters and set desired values.

Calculate the Pr. 94 value from the following formula.

$$\text{Pr. 94 setting} = \left(1 - \frac{M^2}{L1 \times L2}\right) \times 100 (\%)$$

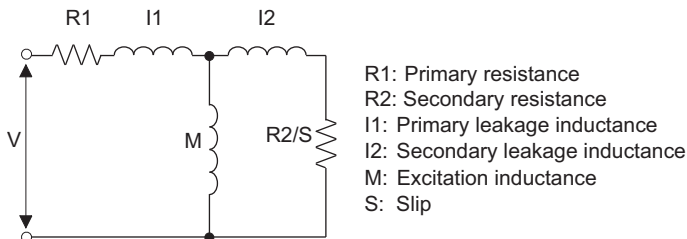

L1 = I1 + M: Primary inductance

L2 = I2 + M: Secondary inductance

Motor equivalent circuit diagram

Parameter Number	Name	Setting Range	Setting Increments	Initial Value
82	Motor excitation current (no load current)	0 to 500A, 9999	0.01A	9999
90	Motor constant (R1)	0 to 50Ω, 9999	0.001Ω	9999
91	Motor constant (R2)	0 to 50Ω, 9999	0.001Ω	9999
92	Motor constant (L1)	0 to 1000mH, 9999	0.1mH	9999
93	Motor constant (L2)	0 to 1000mH, 9999	0.1mH	9999
94	Motor constant (X)	0 to 100%, 9999	0.1%	9999
859	Torque current	0 to 500A, 9999	0.01A	9999

3) Refer to the following table and set Pr. 83 and Pr. 84.

Parameter Number	Name	Setting Range	Setting Increments	Initial Value	
83	Rated motor voltage	0 to 1000V	0.1V	200V class	200V
				400V class	400V
84	Rated Motor Frequency	10 to 120Hz	0.01Hz	60Hz	

REMARKS

• When "9999" is set in Pr. 82, Pr. 90 to Pr. 94, Pr. 859, Mitsubishi motor (SF-JR, SF-HR, SF-JRCA, SF-HRCA) constants are used.

Parameters referred to

- Pr. 7 Acceleration time, Pr. 8 Deceleration time Refer to page 135
- Pr. 9 Electronic thermal O/L relay Refer to page 142
- Pr. 71 Applied motor Refer to page 144
- Pr. 80 Motor capacity, Pr. 81 Number of motor poles Refer to page 112
- Pr. 156 Stall prevention operation selection Refer to page 120
- Pr. 180 to Pr. 184 (input terminal function selection) Refer to page 163
- Pr. 190 to Pr. 192, Pr. 313 to Pr. 315 (output terminal function selection) Refer to page 167
- Pr. 800 Control method selection Refer to page 112

5.12 Motor brake and stop operation

Purpose	Parameter that should be Set		Refer to Page
Motor braking torque adjustment	DC Injection brake	Pr. 10 to Pr. 12	154
Improve the motor braking torque with an option	Selection of a regenerative brake	Pr. 30, Pr. 70	155
Coast the motor to a stop	Selection of motor stopping method	Pr. 250	157
Used to stop the motor with a mechanical brake (vibration restraint at stop-on-contact)	Stop-on-contact control	Pr. 6, Pr. 48, Pr. 270, Pr. 275, Pr. 276	158
Used to stop the motor with a mechanical brake (operation timing of a mechanical brake)	Brake sequence function	Pr. 278 to Pr. 283, Pr. 292	160

5.12.1 DC injection brake (Pr. 10 to Pr. 12)

The DC injection brake can be operated at a motor stop to adjust the stop timing and braking torque. In DC injection brake operation, DC voltage is directly applied to the motor to prevent the motor shaft from rotating. The motor will not return to the original position if the motor shaft rotates due to external force.

Parameter Number	Name	Initial Value	Setting Range	Description
10	DC injection brake operation frequency	3Hz	0 to 120Hz	Operation frequency of the DC injection brake.
11	DC injection brake operation time	0.5s	0	DC injection brake disabled
			0.1 to 10s	Operation time of the DC injection brake.
12	DC injection brake operation voltage	0.1K, 0.2K	6%	DC injection brake voltage (torque). When "0" is set, DC injection brake is disabled.
		0.4K to 7.5K	4%	
		11K, 15K	2%	

The above parameters can be set when Pr. 160 User group read selection = "0". (Refer to page 197)

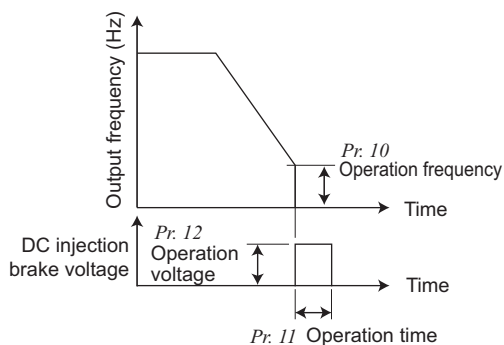

(1) Operation frequency setting (Pr. 10)

- When the frequency at which the DC injection brake will be operated is set to Pr. 10, the DC voltage is applied to the motor upon reaching to the set frequency during deceleration.

(2) Operation time setting (Pr. 11)

- In Pr. 11, set the time of the DC injection brake.
- When the motor does not stop due to large load moment (J), increasing the setting produces an effect.
- When Pr. 11 = "0s", the DC injection brake is disabled. (At a stop, the motor coasts.)

(3) Operation voltage (torque) setting (Pr. 12)

- Use Pr. 12 to set the percentage to the power supply voltage.
- When Pr. 12 = "0%", the DC injection brake is disabled. (At a stop, the motor coasts.)
- When using the constant-torque motor (SF-JRCA) and energy saving motor (SF-HR, SF-HRCA), change the Pr. 12 setting as follows:

Motor	Pr.12 DC injection brake operation voltage Setting	
SF-JRCA	3.7K or lower	4%
	5.5K or higher	2%
SF-HR, SF-HRCA	3.7K or lower	4%
	5.5K, 7.5K	3%
	11K, 15K	2%

REMARKS

- For the 5.5K, 7.5K, when the Pr. 12 setting is the following, changing the Pr. 71 Applied motor setting automatically changes the Pr. 12 setting. Therefore, it is not necessary to change the Pr. 12 setting.
 - When 4% (initial value) is set in Pr. 12
The Pr. 12 setting is automatically changed to 2% if the Pr. 71 value is changed from the value selecting the standard motor (0, 3 to 6, 23, 24, 40, 43, 44) to the value selecting the constant-torque motor (1, 13 to 16, 50, 53, 54).
 - When 2% is set in Pr. 12
The Pr. 12 setting is automatically changed to 4% (initial value) if the Pr. 71 value is changed from the value selecting the constant-torque motor (1, 13 to 16, 50, 53, 54) to the value selecting the standard motor (0, 3 to 6, 23, 24, 40, 43, 44).
- Even if the Pr. 12 setting is increased, braking torque is limited so that the output current is within the rated inverter current.

 **CAUTION**

 As stop holding torque is not produced, install a mechanical brake.



Parameters referred to

Pr. 13 Starting frequency  Refer to page 138

Pr. 71 Applied motor  Refer to page 144

5.12.2 Selection of a regenerative brake (Pr. 30, Pr. 70)

- When making frequent starts/stops, use the optional brake resistor (MRS type, MYS type), high-duty brake resistor (FR-ABR) and brake unit (FR-BU2) to increase the regenerative brake duty.

Parameter Number	Name	Initial Value	Setting Range	Description
30	Regenerative function selection	0	0	Inverter without regenerative function Brake resistor (MRS type, MYS type) Brake unit (FR-BU2)
			1	Brake resistor (MYS type) used at 100% torque / 6%ED High-duty brake resistor (FR-ABR)
			2	For manufacturer setting. Do not set.
70	Special regenerative brake duty	0%	0 to 30%	Brake duty (6%) when using the brake resistor (MYS type), Brake duty when using the high-duty brake resistor (FR-ABR)(10%)

The above parameters can be set when Pr. 160 User group read selection = "0". (Refer to page 197)

(1) When using the brake resistor (MRS type, MYS type), brake unit (FR-BU2).

- Set Pr. 30 to "0" (initial value). The Pr. 70 setting is made invalid.
- At this time, the regenerative brake duty is as follows.

Model	Regenerative Brake Duty
FR-E720-0.4KNC to 3.7KNC FR-E720S-0.4KNC or higher	3%
FR-E720-5.5KNC or higher FR-E740-0.4KNC or higher	2%

(2) When using the brake resistor (MYS type) at 100% torque / 6%ED (FR-E720-3.7KNC only)

- Set "1" in Pr. 30.
- Set "6%" in Pr. 70.

(3) When using the high-duty brake resistor (FR-ABR) (0.4K or higher)

- Set "1" in Pr. 30.
- Set Pr. 70 as follows.
7.5K or lower 10%
11K, 15K 6%

(4) Regenerative brake duty alarm output and alarm signal (RBP signal)

100%: regenerative overvoltage protection operation value

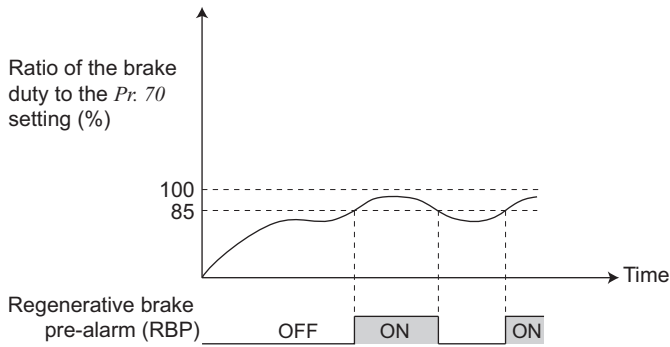

- [RB] appears on the operation panel and an alarm signal (RBP) is output when 85% of the regenerative brake duty set in Pr. 70 is reached. If the regenerative brake duty reaches 100% of the Pr. 70 setting, a regenerative overvoltage (E.OV1 to E.OV3) occurs. Note that [RB] is not displayed when Pr. 30 = "0".
- The inverter does not trip even when the alarm (RBP) signal is output.
- To assign the RBP signal to the terminal Y0 or a virtual terminal of CC-Link communication, set "7 (positive logic) or 107 (negative logic)" in one of Pr. 190 to Pr. 192 and Pr. 313 to Pr. 315 (output terminal function selection).

REMARKS

- Refer to page 26 to 29 for connecting the brake resistor (MRS type, MYS type), high-duty brake resistor (FR-ABR), brake unit (FR-BU2).

NOTE

- Changing the assignment of the terminal Y0 or a virtual terminal of CC-Link communication with one of Pr. 190 to Pr. 192, and Pr. 313 to Pr. 315 (output terminal function selection) may affect other functions. Set parameters after confirming the function of the terminal Y0 and virtual terminals.

WARNING

- ⚠ The value set in Pr. 70 must not exceed the setting of the brake resistor used. Otherwise, the resistor can overheat.



Parameters referred to

Pr. 57 Restart coasting time Refer to page 180

Pr. 190 to Pr. 192, Pr. 313 to Pr. 315 (output terminal function selection) Refer to page 167

5.12.3 Stop selection (Pr. 250)

Used to select the stopping method (deceleration to a stop or coasting) when the start signal turns OFF.
Used to stop the motor with a mechanical brake, etc. together with switching OFF of the start signal.

Parameter Number	Name	Initial Value	Setting Range	Description
				Stop operation
250	Stop selection	9999	0 to 100s	The motor is coasted to a stop when the preset time elapses after the start signal is turned OFF.
			9999	When the start signal is turned OFF, the motor decelerates to stop.
			1000s to 1100s, 8888	For manufacturer setting. Do not set.

The above parameters can be set when Pr. 160 User group read selection = "0". (Refer to page 197)

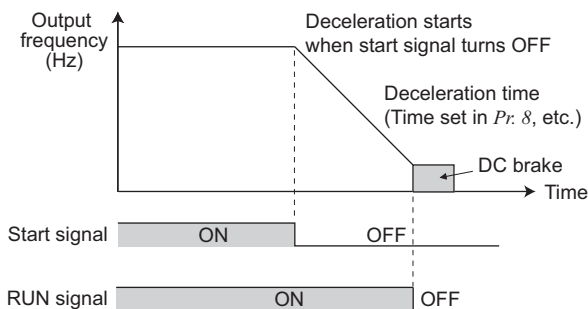

(1) Decelerate the motor to a stop

- Set Pr. 250 to "9999" (initial value) or "8888".
- The motor decelerates to a stop when the start signal (STF/STR) turns OFF.

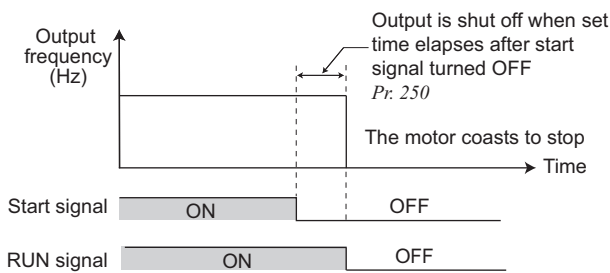

(2) Coast the motor to a stop

- Use Pr. 250 to set the time from when the start signal turns OFF until the output is shut off. When any of "1000 to 1100" is set, the output is shut off in (Pr. 250 - 1000)s.
- The output is shut off when the time set in Pr. 250 has elapsed after the start signal had turned OFF. The motor coasts to a stop.
- The RUN signal turns OFF when the output stops.

REMARKS

- Stop selection is invalid when the following functions are activated.
 - Power failure stop function (Pr. 261)
 - PU stop (Pr. 75)
 - Deceleration stop because of communication error (Pr. 502)
- When setting of Pr. 250 is not 9999, acceleration/deceleration is performed according to the frequency command, until start signal is OFF and output is shutoff.

NOTE

- When the start signal is turned ON again during motor coasting, the motor starts at Pr. 13 Starting frequency.

Parameters referred to

Pr. 7 Acceleration time, Pr. 8 Deceleration time Refer to page 135
Pr. 13 Starting frequency Refer to page 138

5.12.4 Stop-on contact control function (Pr. 6, Pr. 48, Pr. 270, Pr. 275, Pr. 276)

AD MFVC GP MFVC

To ensure accurate positioning at the upper limit etc. of a lift, stop-on-contact control causes a mechanical brake to be closed while the motor is developing a holding torque to keep the load in contact with a mechanical stopper etc. This function suppresses vibration which is liable to occur when the load is stopped upon contact in vertical motion applications, ensuring steady precise positioning.

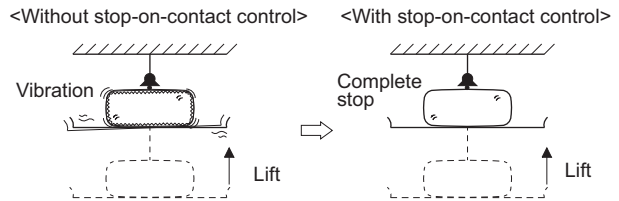

Parameter Number	Name	Initial Value	Setting Range	Description
6	Multi-speed setting (low speed)	10Hz	0 to 400Hz	Sets the output frequency for stop-on-contact control.
48 *1	Second stall prevention operation current	9999	0 to 200%	Sets the stall prevention operation level for stall prevention operation level.
			9999	Pr. 22 setting
270 *1	Stop-on contact control selection	0	0	Normal operation
			1	Stop-on-contact control
275 *1, *2	Stop-on contact excitation current low-speed multiplying factor	9999	0 to 300%	Set the force (holding torque) for stop-on-contact control. Normally set 130% to 180%.
			9999	Without compensation
276 *1	PWM carrier frequency at stop-on contact	9999	0 to 9	Sets a PWM carrier frequency for stop-on-contact control.
			9999	As set in Pr. 72 PWM frequency selection.

*1 This parameter can be set when Pr. 160 User group read selection = "0". (Refer to page 197)

*2 This parameter allows its setting to be changed during operation even if "0" (initial value) is set in Pr. 77 Parameter write selection.

(1) Operation example

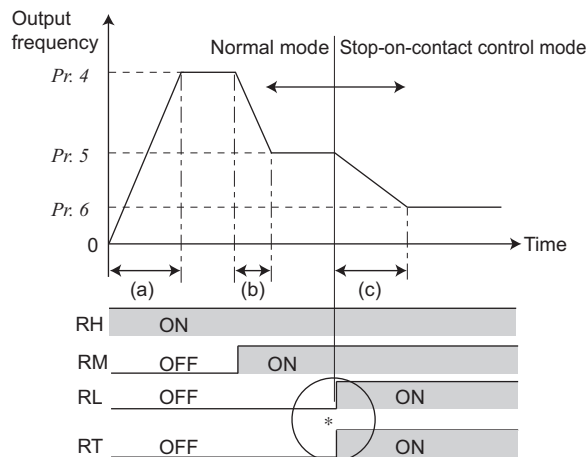

* Goes into stop-on-contact control when both RL and RT switch ON.
RL and RT may be switched on in any order with any time difference.

(a) Acceleration time (Pr. 7) (b) Deceleration time (Pr. 8)
(c) Second deceleration time (Pr. 44/Pr. 45)

(2) Set stop-on-contact control

- Make sure that the inverter is in Network operation mode. (Refer to page 103)
- Select Advanced magnetic flux vector control or General-purpose magnetic flux vector control.
- Set "1" in Pr. 270 Stop-on contact control selection.
- Set output frequency during stop-on-contact control in Pr. 6 Multi-speed setting (low speed).
The frequency should be as low as possible (about 2Hz). If it is set to more than 30Hz, the operating frequency will be 30Hz.
- When both the RT and RL signals are switched ON, the inverter starts the stop-on-contact control, in which operation is performed at the frequency set in Pr. 6 independently of the preceding speed.
- To input the RT signal to a virtual terminal of CC-Link communication, set "3" in one of Pr. 180 to Pr. 184 (input terminal function selection). To input the RL signal to a virtual terminal of CC-Link communication, set "0" in one of Pr. 180 to Pr. 184 (input terminal function selection).

NOTE



- By increasing the Pr. 275 setting, the low-speed (stop-on-contact) torque increases, but overcurrent fault (E.OCT) may occur or the machine may oscillate in a stop-on-contact state.
- The stop-on-contact function is different from servo-lock function, and if used to stop or hold a load for an extended period, this function can cause the motor to overheat.
After a stop, immediately change to a mechanical brake to hold the load.
- Under the following operating conditions, the stop-on-contact function is invalid:
PU operation (Pr. 79), Jog operation, PID control function operation (Pr. 128), remote setting function operation (Pr. 59), automatic acceleration/deceleration operation (Pr. 292)

(3) Function switching of stop-on-contact control selection

Main Functions	Normal Operation (either RL or RT is OFF or both are OFF)	With stop-on-contact Control (both RL and RT are ON)
Output frequency	Multi-speed operation setting, set frequency, etc. (Refer to page 60.)	Pr. 6 setting
Stall prevention operation level	Pr. 22 setting	Pr. 48 setting (Pr. 22 when Pr. 48 = "9999")
Excitation current low speed scaling factor	—	Only Pr. 275 (0 to 300%) is compensated from normal operation
Carrier frequency	Pr. 72 setting	Pr. 276 setting when output frequency is 3Hz or less (Pr. 72 when Pr. 276 = "9999")
Fast-response current limit	Valid	Invalid

(4) Set frequency when stop-on-contact control (Pr. 270 = 1) is selected

- The following table lists the frequencies set when the input terminals (RH, RM, RL, RT) are selected together. Bold frame indicates stop-on-contact control is valid.
- Stop-on-contact control is invalid when remote setting function is selected (Pr. 59 = 1 to 3).

Input Signal (○ = ON)				Set Frequency
RH	RM	RL	RT	
○				Pr. 4 Multi-speed setting (high speed)
	○			Pr. 5 Multi-speed setting (middle speed)
		○		Pr. 6 Multi-speed setting (low speed)
			○	Set frequency. (Refer to page 60.)
○	○			Pr. 26 Multi-speed setting (speed 6)
○		○		Pr. 25 Multi-speed setting (speed 5)
○			○	Pr. 4 Multi-speed setting (high speed)
	○	○		Pr. 24 Multi-speed setting (speed 4)
	○		○	Pr. 5 Multi-speed setting (middle speed)
		○	○	Pr. 6 Multi-speed setting (low speed)
	○	○	○	Pr. 6 Multi-speed setting (low speed)
○		○	○	Pr. 6 Multi-speed setting (low speed)
○	○		○	Pr. 26 Multi-speed setting (speed 6)
○	○	○		Pr. 27 Multi-speed setting (speed 7)
○	○	○	○	Pr. 6 Multi-speed setting (low speed)
				Set frequency. (Refer to page 60.)











NOTE

- Changing the assignment of a virtual terminal of CC-Link communication with Pr. 180 to Pr. 184 (input terminal function selection) may affect other functions. Set parameters after confirming the function of each virtual terminal.



Parameters referred to

- Pr. 4 to Pr. 6, Pr. 24 to Pr. 27 (multi-speed setting)  Refer to page 130
- Pr. 15 Jog frequency  Refer to page 201
- Pr. 48 Second stall prevention operation current  Refer to page 120
- Pr. 59 Remote function selection  Refer to page 132
- Pr. 72 PWM frequency selection  Refer to page 192
- Pr. 79 Operation mode selection  Refer to page 103
- Pr. 128 PID action selection  Refer to page 203
- Pr. 180 to Pr. 184 (input terminal function selection)  Refer to page 163
- Pr. 292 Automatic acceleration/deceleration  Refer to page 140

5.12.5 Brake sequence function (Pr. 278 to Pr. 283, Pr. 292) AD MFVC GP MFVC

This function is used to output from the inverter the mechanical brake operation timing signal in vertical lift and other applications.

This function prevents the load from dropping with gravity at a start due to the operation timing error of the mechanical brake or an overcurrent alarm from occurring at a stop, ensuring secure operation.

Parameter Number	Name	Initial Value	Setting Range	Description
278	Brake opening frequency	3Hz	0 to 30Hz	Set to the rated slip frequency of the motor + about 1.0Hz. This parameter may be set only if $Pr. 278 \leq Pr. 282$.
279	Brake opening current	130%	0 to 200%	Generally, set this parameter to about 50 to 90%. If the setting is too low, the load is liable to drop due to gravity at start. Suppose that the rated inverter current is 100%.
280	Brake opening current detection time	0.3s	0 to 2s	Generally, set this parameter to about 0.1 to 0.3s.
281	Brake operation time at start	0.3s	0 to 5s	When $Pr. 292 = "7"$, set the mechanical delay time until the brake is loosened. Set the mechanical delay time until the brake is loosened + about 0.1 to 0.2s when $Pr. 292 = "8"$.
282	Brake operation frequency	6Hz	0 to 30Hz	Set the frequency to activate the mechanical brake by turning OFF the brake opening request signal (BOF). Generally, set this parameter to the $Pr. 278$ setting + 3 to 4Hz. This parameter may be set only if $Pr. 278 \leq Pr. 282$.
283	Brake operation time at stop	0.3s	0 to 5s	Set the mechanical delay time until the brake is closed + 0.1s when $Pr. 292 = 7$. Sets the mechanical delay time until the brake is closed + 0.2 to 0.3s when $Pr. 292 = 8$.
292	Automatic acceleration/ deceleration	0	0	Normal operation mode
			1, 11	Shortest acceleration/deceleration mode (Refer to page 140)
			7	Brake sequence mode 1
			8	Brake sequence mode 2

The above parameters can be set when $Pr. 160$ User group read selection = "0". (Refer to page 197)

(1) Set the brake sequence mode

- Select Advanced magnetic flux vector control or General-purpose magnetic flux vector control.
The brake sequence function is valid only when the Network operation mode is selected.
- Set "7 or 8" (brake sequence mode) in $Pr. 292$.
To ensure more complete sequence control, it is recommended to set "7" (brake opening completion signal input) in $Pr. 292$.
- Set "15" in any of $Pr. 180$ to $Pr. 184$ (input terminal function selection) and assign the brake opening completion signal (BRI) to a virtual terminal of CC-Link communication.
- To assign the brake opening request (BOF signal) to the terminal Y0 or a virtual terminal of CC-Link communication, set "20 (positive logic) or 120 (negative logic)" in one of $Pr. 190$ to $Pr. 192$ and $Pr. 313$ to $Pr. 315$ (output terminal function selection).



NOTE

- When brake sequence function is selected, automatic restart after instantaneous power failure is invalid.
- When using this function, set the acceleration time to 1s or longer.
- Changing the assignment of the terminal Y0 or a virtual terminal of CC-Link communication with one of $Pr. 180$ to $Pr. 184$, $Pr. 190$ to $Pr. 192$, and $Pr. 313$ to $Pr. 315$ may affect other functions. Set parameters after confirming the function of the terminal Y0 and virtual terminals.

(2) With brake opening completion signal input (Pr. 292 = "7")

- When the start signal is input to the inverter, the inverter starts running. When the internal speed command reaches the value set in Pr. 278 and the output current is not less than the value set in Pr. 279, the inverter outputs the brake opening request signal (BOF) after the time set in Pr. 280 has elapsed. When the time set in Pr. 281 elapses after the brake opening completion signal (BRI) was activated, the inverter increases the output frequency to the set speed.
- When the inverter decelerates to the frequency set in Pr.282 during deceleration, the inverter turns OFF the BOF signal and decelerates further to the frequency set in Pr.278. After electromagnetic brake operation completes and inverter recognizes the turn OFF of BRI signal, the inverter holds the frequency set in Pr.278 for the time set in Pr.283. And after the time set in Pr.283 passes, the inverter decelerates again. The inverter finally stops when its frequency reaches to Pr.13 Starting frequency setting or 0.5Hz, whichever is lower.

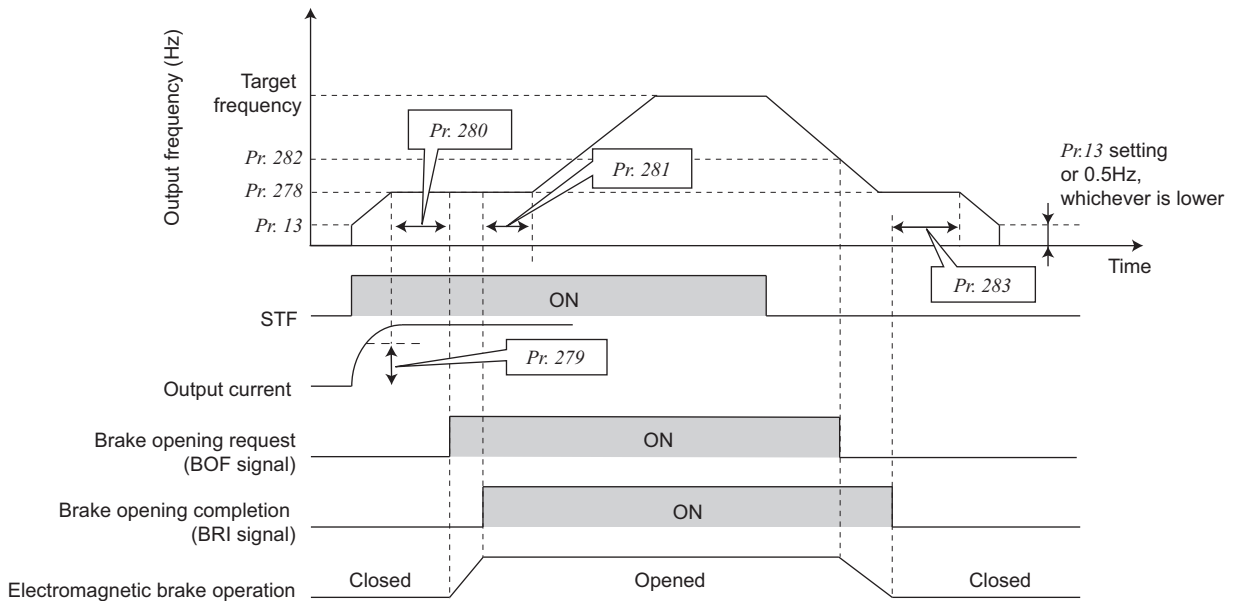

(3) Without brake opening completion signal input (Pr. 292 = "8")

- When the start signal is input to the inverter, the inverter starts running. When the internal speed command reaches the value set in Pr. 278 and the output current is not less than the value set in Pr. 279, the inverter outputs the brake opening request signal (BOF) after the time set in Pr. 280 has elapsed. When the time set in Pr. 281 elapses after the BOF signal is output, the inverter increases the output frequency to the set speed.
- When the inverter decelerates to the frequency set in Pr.282 during deceleration, the inverter turns OFF the BOF signal and decelerates further to the frequency set in Pr.278. After the turn OFF of BOF signal, the inverter holds the frequency set in Pr.278 for the time set in Pr.283. And after the time set in Pr.283 passes, the inverter decelerates again. The inverter finally stops when its frequency reaches to Pr.13 Starting frequency setting or 0.5Hz, whichever is lower.

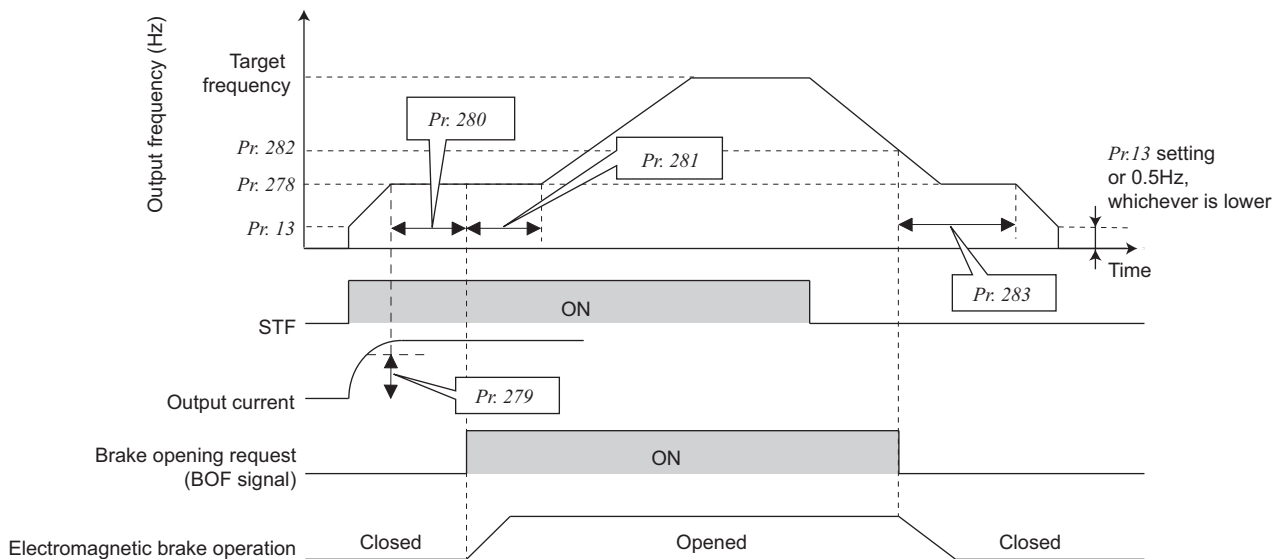



REMARKS

- If brake sequence function has been selected, inputting the RT signal (second function selection) during an inverter stop will make brake sequence function invalid and give priority to the second function selection. Note that RT signal input is invalid even if RT signal is input during operation with brake sequence function.

(4) Protective functions

If any of the following occurs during the brake sequence operation, the inverter results in a fault, trips, and turns OFF the brake opening request signal (BOF).

Fault Display	Description
E.MB4	Although more than 2s have elapsed after the start command (forward or reverse rotation) is input, the brake opening request signal (BOF) does not turn ON.
E.MB5	Although more than 2s have elapsed after the brake opening request signal (BOF) turned on, the brake opening completion signal (BRI) does not turn ON.
E.MB6	Although the inverter had turned ON the brake opening request signal (BOF), the brake opening completion signal (BRI) turned OFF midway.
E.MB7	Although more than 2s have elapsed after the brake opening request signal (BOF) turned OFF at a stop, the brake opening completion signal (BRI) does not turn OFF.



NOTE

- During deceleration, inverter output is shut OFF when the frequency reaches *Pr.13 Starting frequency* or **0.5Hz**, whichever is lower. For *Pr.278 Brake opening frequency*, set *Pr.13* or a frequency equal to or higher than **0.5Hz**.
- Setting *Pr. 278 Brake opening frequency* too high activates stall prevention operation and may cause **E.MB4**.
- If the sum of the time between *Pr. 13 Starting frequency* and *Pr. 278 Brake opening frequency* + *Pr. 280 Brake opening current detection time* is more than **2s**, **E.MB4** occurs.

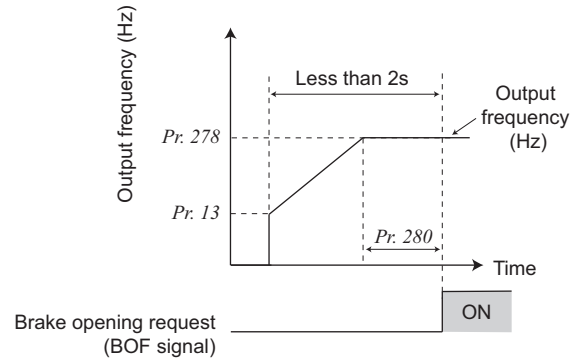

Parameters referred to

- Pr. 13 Starting frequency* Refer to page 138
- Pr. 80 Motor capacity, Pr. 81 Number of motor poles* Refer to page 112
- Pr. 180 to Pr. 184 (input terminal function selection)* Refer to page 163
- Pr. 190 to Pr. 192, Pr. 313 to Pr. 315 (output terminal function selection)* Refer to page 167
- Pr. 800 Control method selection* Refer to page 112

5.13 Function assignment of external terminals and CC-Link communication virtual terminals

Purpose	Parameter that should be Set		Refer to Page
To assign functions to the input virtual terminals of CC-Link communication	Input terminal function selection	Pr. 180 to Pr. 184	163
To set MRS signal (output shutoff) in NC contact specification	MRS input selection	Pr. 17	166
To assign functions to the terminal Y0 or output virtual terminals of CC-Link communication	Output terminal function assignment	Pr. 190 to Pr. 192, Pr. 313 to Pr. 315	167
To detect output frequency	Up-to-frequency sensitivity Output frequency detection	Pr. 41 to Pr. 43	171
To detect output current	Output current detection Zero current detection	Pr. 150 to Pr. 153	172
To use the remote output function	Remote output	Pr. 495, Pr. 496	174

5.13.1 Input terminal function selection (Pr. 180 to Pr. 184)

Use the parameters to select and change the functions assigned to input virtual terminals of CC-Link communication.

Parameter Number	Name	Initial Value	Initial Signal	Setting Range
180	RY4 function selection	0	RL (low-speed operation command)	0 to 5, 7, 8, 10, 12, 14 to 16, 18, 24, 25, 62, 65 to 67, 9999*
181	RY3 function selection	1	RM (middle speed operation command)	
182	RY2 function selection	2	RH (high-speed operation command)	
183	RY9 function selection	24	MRS (output stop)	
184	RYB function selection	62	Function invalid	

The above parameters can be set when Pr. 160 User group read selection = "0". (Refer to page 197)

* The setting values "4, 5, 7, 10, 12, 16, 25, 62, and 65 to 67" are for manufacturer setting. Do not set.

(1) Input terminal function assignment

- Using Pr. 180 to Pr. 184, set the functions of the input virtual terminals.
- Refer to the following table and set the parameters:

Setting	Signal	Function	Related Parameters	Refer to Page	
0	RL	Pr. 59 = 0 (initial value)	Low-speed operation command	Pr. 4 to Pr. 6, Pr. 24 to Pr. 27 Pr.232 to Pr.239	130
		Pr. 59 = 1, 2 *1	Remote setting (setting clear)	Pr. 59	132
		Pr. 270 = 1 *2	Stop-on contact selection 0	Pr. 270, Pr. 275, Pr. 276	158
1	RM	Pr. 59 = 0 (initial value)	Middle-speed operation command	Pr. 4 to Pr. 6, Pr. 24 to Pr. 27, Pr. 232 to Pr. 239	130
		Pr. 59 = 1, 2 *1	Remote setting (deceleration)	Pr. 59	132
2	RH	Pr. 59 = 0 (initial value)	High-speed operation command	Pr. 4 to Pr. 6, Pr. 24 to Pr. 27, Pr. 232 to Pr. 239	130
		Pr. 59 = 1, 2 *1	Remote setting (acceleration)	Pr. 59	132
3	RT	Second function selection		Pr. 44 to Pr. 51	165
		Pr. 270 = 1 *2	Stop-on contact selection 1	Pr. 270, Pr. 275, Pr. 276	158
4, 5, 7	For manufacturer setting. Do not set.				
8	REX	15-speed selection (combination with three speeds RL, RM, RH)	Pr. 4 to Pr. 6, Pr. 24 to Pr. 27, Pr. 232 to Pr. 239	130	
10, 12	For manufacturer setting. Do not set.				
14	X14	PID control valid terminal	Pr. 127 to Pr. 132, Pr. 134	203	
15	BRI	Brake opening completion signal	Pr. 278 to Pr. 283	160	
16	For manufacturer setting. Do not set.				
18	X18	V/F switchover (V/F control is performed when X18 is ON)	Pr. 80, Pr. 81, Pr. 800	112, 114, 117, 146	
24	MRS	Output stop	Pr. 17	166	
25, 62, 65 to 67	For manufacturer setting. Do not set.				
9999	—	No function	—	—	

*1 When Pr. 59 Remote function selection = "1" or "2", the functions of the RL, RM and RH signals are changed as given in the table.

*2 When Pr. 270 Stop-on contact control selection = "1", functions of RL and RT signals are changed as in the table.



NOTE

- Changing the assignment of a virtual terminal of CC-Link communication with Pr. 180 to Pr. 184 (input terminal function selection) may affect other functions. Set parameters after confirming the function of each virtual terminal.
- Same function can be assigned to two or more virtual terminals. In this case, the logic of virtual terminals input is OR.
- The priorities of the speed commands are in order of multi-speed setting (RH, RM, RL, REX) > PID (X14).
- Same virtual terminals are used to assign multi-speed (7 speeds) and remote setting. They cannot be set individually. (Same signal is used since multi-speed (7 speeds) setting and remote setting are not used to set speed at the same time.)
- Switch the control method using external terminal (X18 signal) during an inverter stop. If control method between V/F control and Advanced (General-purpose magnetic) flux vector control is switched during the operation, the actual switchover does not take place until the inverter stops. In addition, if control method is switched to V/F control during the operation, only second function becomes valid as V/F control and second function are selected simultaneously in V/F control.

(2) Second function selection signal (RT)

- When the RT signal turns ON, the second function becomes valid.
- For the RT signal, set "3" in any of Pr. 180 to Pr. 184 (input terminal function selection) to assign the function.
- The second function has the following applications.
 - (a) Switching between normal use and emergency use
 - (b) Switching between heavy load and light load
 - (c) Changing of acceleration/deceleration time by broken line acceleration/deceleration
 - (d) Switching of characteristic between the main motor and sub motor

Second acceleration/deceleration time

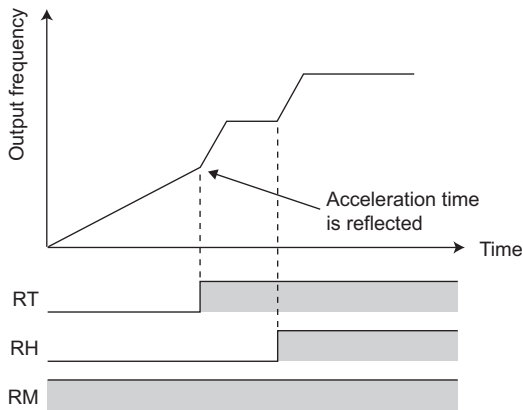

- When the RT signal is ON, the following second functions are selected at the same time.

Function	First Function Parameter Number	Second Function Parameter Number	Refer to Page
Torque boost	Pr. 0	Pr. 46	113
Base frequency	Pr. 3	Pr. 47	126
Acceleration time	Pr. 7	Pr. 44	135
Deceleration time	Pr. 8	Pr. 44, Pr. 45	135
Electronic thermal O/L relay	Pr. 9	Pr. 51	142
Stall prevention	Pr. 22	Pr. 48	120
Applied motor	Pr. 71	Pr. 450	144

(3) Operation using start signals (STF and STR signals)

- The forward/reverse rotation signals (STF/STR) are used as start and stop signals. Turn ON either of the forward and reverse rotation signals to start the motor in the corresponding direction. Switch both OFF (or both ON) of the start signals during operation to decelerate the inverter to a stop.
- The frequency can be set with Pr. 4 to Pr. 6 Multi-speed setting (high, middle, low speeds), etc.

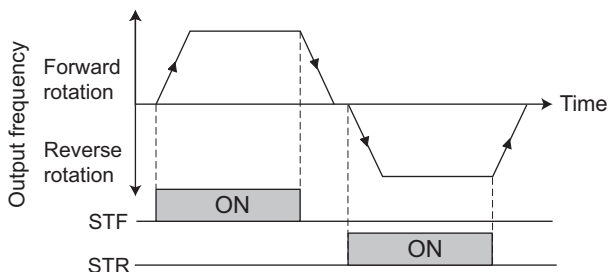

REMARKS

- When Pr. 250 is set to any of "0 to 100", turning OFF the start command coasts the inverter to a stop. (Refer to page 157)



Parameters referred to

- Pr. 4 to Pr. 6 Multi-speed setting Refer to page 130
- Pr. 250 Stop selection Refer to page 157

5.13.2 Inverter output shutoff signal (MRS signal, Pr. 17)

The inverter output can be shut off by the MRS signal. Also, logic for the MRS signal can be selected.

Parameter Number	Name	Initial Value	Setting Range	Description
17	MRS input selection	0	0, 4	Normally open input
			2	Normally closed input (NC contact input specifications)

The above parameters can be set when Pr. 160 User group read selection = "0". (Refer to page 197)

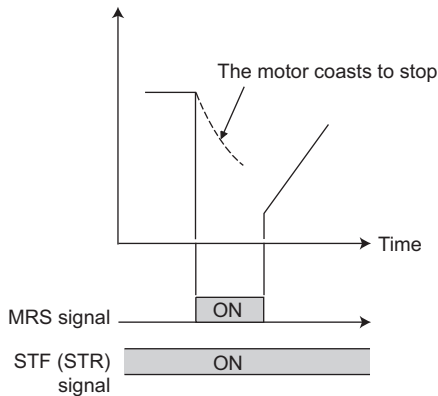

(1) Output shutoff signal (MRS signal)

- Turning ON the output shutoff signal (MRS) during inverter running shuts off the output immediately.
- MRS signal may be used as described below.
 - (a) When mechanical brake (e.g. electromagnetic brake) is used to stop motor
The inverter output is shut off when the mechanical brake operates.
 - (b) To provide interlock to disable operation by the inverter
With the MRS signal ON, the inverter cannot be operated if the start signal is entered into the inverter.
 - (c) Coast the motor to a stop.
When the start signal is turned OFF, the inverter decelerates the motor to a stop in the preset deceleration time, but when the MRS signal is turned ON, the motor coasts to a stop.

(2) MRS signal logic inversion (Pr. 17)

- When Pr. 17 is set to "2", the MRS signal (output stop) can be changed to the normally closed (NC contact) input specification. When the MRS signal turns ON (opens), the inverter shuts off the output.



REMARKS

- The MRS signal is initially assigned to a virtual terminal of CC-Link communication. Set "24" in one of Pr. 180 to Pr. 184 (input terminal function selection) to assign the MRS signal to another virtual terminal.



NOTE

- Changing the assignment of a virtual terminal of CC-Link communication with Pr. 180 to Pr. 184 (input terminal function selection) may affect other functions. Set parameters after confirming the function of each virtual terminal



Parameters referred to

Pr. 180 to Pr. 184 (input terminal function selection) Refer to page 163

5.13.3 Output terminal function selection (Pr. 190 to Pr. 192, Pr. 313 to Pr. 315)

The function assigned to the terminal Y0 or an output virtual terminal of CC-Link communication can be changed.

Parameter Number	Name	Initial Value	Initial Signal	Setting Range
190 *1	RX2 (terminal Y0) function selection	0	RUN (inverter running)	0, 1, 3, 4, 7, 8, 11 to 16, 20, 25, 26, 46, 47, 64, 68, 80, 81, 90, 91, 93*2, 95, 96*3, 98, 99, 100, 101, 103, 104, 107, 108, 111 to 116, 120, 125, 126, 146, 147, 164, 168, 180, 181, 190, 191, 193*2, 195, 196*3, 198, 199, 9999
191 *1	RX6 function selection	4	FU (output frequency detection)	
192 *1	RX7 function selection	99	ALM (fault output)	
313	RX9 function selection	9999	No function	
314	RXA function selection	9999	No function	
315	RXB function selection	9999	No function	

*1 The above parameters can be set when Pr. 160 User group read selection = "0". (Refer to page 197)

*2 The setting values "93" and "193" are not available for Pr. 192.

*3 The setting values "96" and "196" are only available for Pr. 190. When these values are set in Pr. 191, Pr. 192, and Pr. 313 to Pr. 315, their functions are invalid.

(1) Output signal list

- A function can be assigned to the terminal Y0 or an output virtual terminal of CC-Link communication.
- Refer to the following table and set the parameters: (0 to 99: positive logic, 100 to 199: negative logic)

Setting		Signal	Function	Operation	Related Parameter	Refer to Page
Positive logic	Negative logic					
0	100	RUN	Inverter running	Output during operation when the inverter output frequency rises to or above Pr. 13 Starting frequency.	—	169
1	101	SU	Up to frequency *	Output when the output frequency is reached to the set frequency.	Pr. 41	171
3	103	OL	Overload alarm	Output while stall prevention function is activated.	Pr. 22, Pr. 23, Pr. 66	120
4	104	FU	Output frequency detection	Output when the output frequency reaches the frequency set in Pr. 42 (Pr. 43 for reverse rotation).	Pr. 42, Pr. 43	171
7	107	RBP	Regenerative brake pre-alarm	Output when 85% of the regenerative brake duty set in Pr. 70 is reached.	Pr. 70	155
8	108	THP	Electronic thermal O/L relay pre-alarm	Output when the electronic thermal value reaches 85% of the trip level. (Electronic thermal relay function protection (E.THT/E.THM) activates, when the value reached 100%.)	Pr. 9, Pr. 51	142
11	111	RY	Inverter operation ready	Output when reset process is completed (when the inverter can be started by switching the start signal ON or while it is running) after powering on inverter.	—	169
12	112	Y12	Output current detection	Output when the output current is higher than the Pr. 150 setting for longer than the time set in Pr. 151.	Pr. 150, Pr. 151	172
13	113	Y13	Zero current detection	Output when the output power is lower than the Pr. 152 setting for longer than the time set in Pr. 153.	Pr. 152, Pr. 153	172
14	114	FDN	PID lower limit	Output when the feedback value falls below the lower limit of PID control.	Pr. 127 to Pr. 134	203
15	115	FUP	PID upper limit	Output when the feedback value rises above the upper limit of PID control		
16	116	RL	PID forward/reverse rotation output	Output when forward rotation is performed in PID control.		
20	120	BOF	Brake opening request	Output to open the brake when the brake sequence function is selected.	Pr. 278 to Pr. 283, Pr. 292	160
25	125	FAN	Fan fault output	Output at the time of a fan fault.	Pr. 244	213
26	126	FIN	Heatsink overheat pre-alarm	Output when the heatsink temperature reaches about 85% of the heatsink overheat protection providing temperature.	—	239
46	146	Y46	During deceleration at occurrence of power failure	Output when the power failure-time deceleration function is executed. (retained until release)	Pr. 261	186
47	147	PID	During PID control activated	Output during PID control.	Pr. 127 to Pr. 134	203

Setting		Signal	Function	Operation	Related Parameter	Refer to Page
Positive logic	Negative logic					
64	164	Y64	During retry	Output during retry processing.	Pr. 65 to Pr. 69	188
68	168	EV	24V external power supply operation	The signal is output while the main circuit power supply is off and the 24V power is supplied externally.	—	—
80	180	SAFE	Safety monitor output	Output while safety stop function is activated.	—	24
81	181	SAFE2	Safety monitor output 2	The signal is output when no internal safety circuit failure (E.SAF, E.6, E.7, E.CPU) exists.	—	24
90	190	Y90	Life alarm	Output when any of the control circuit capacitor, main circuit capacitor and inrush current limit circuit or the cooling fan approaches the end of its service life.	Pr. 255 to Pr. 259	214
91	191	Y91	Fault output 3 (power-off signal)	Output when a fault occurs due to the internal circuit failure of the inverter wiring mistake.	—	170
93	193	Y93	Current average value monitor signal	Average current value and maintenance timer value are output as pulses. The signal can not be set in <i>Pr. 192 RX7 function selection</i> .	Pr. 555 to Pr. 557	218
95	195	Y95	Maintenance timer signal	Output when <i>Pr. 503</i> rises to or above the <i>Pr. 504</i> setting.	Pr. 503, Pr. 504	217
96	196	REM	Remote output	Output to the terminal when a value is set to the parameter.	Pr. 495, Pr. 496	174
98	198	LF	Alarm output	Output when an alarm (fan failure or communication error warning) occurs.	Pr. 244, Pr. 500	107, 213
99	199	ALM	Fault output	Output when the fault occurs. The signal output is stopped when the fault is reset.	—	170
9999	—	—	No function	—	—	—

* Note that when the frequency setting is varied using an analog signal or  of the operation panel, the output of the SU (up to frequency) signal may alternate ON and OFF depending on that varying speed and the timing of the varying speed due to acceleration/deceleration time setting. (The output will not alternate ON and OFF when the acceleration/deceleration time setting is "0s".)



REMARKS

- The same function may be set to more than one terminal.
- When the function is executed, the terminal conducts at the setting of any of "0 to 99", and does not conduct at the setting of any of "100 to 199".



NOTE

- Changing the assignment of the terminal Y0 or a virtual terminal of CC-Link communication with one of *Pr. 190 to Pr. 192*, and *Pr. 313 to Pr. 315 (output terminal function selection)* may affect other functions. Set parameters after confirming the function of the terminal Y0 and virtual terminals.

(2) Inverter operation ready signal (RY signal) and inverter running signal (RUN signal)

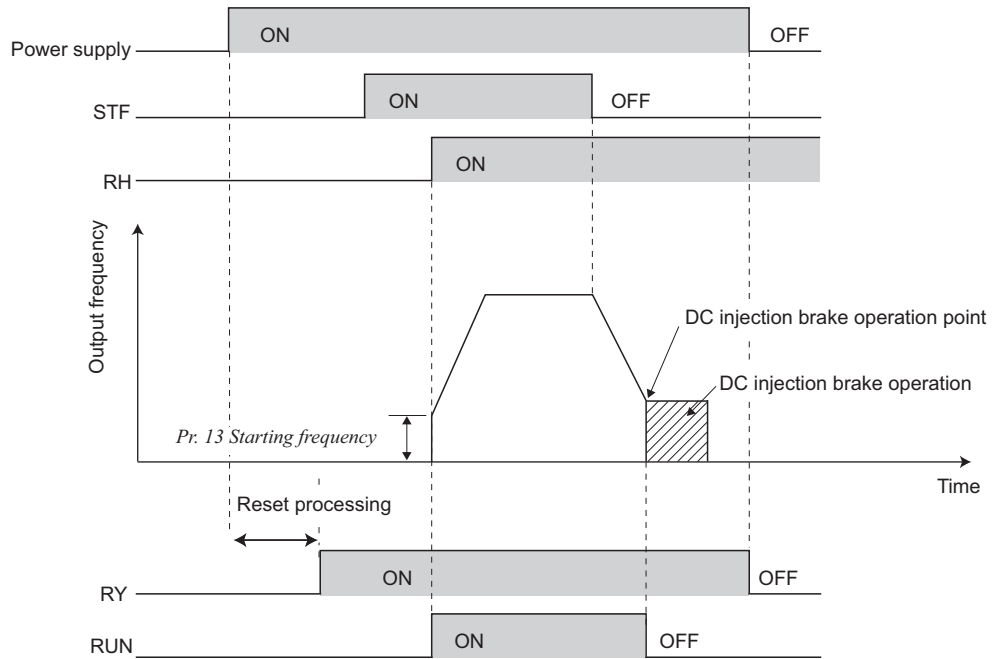

- When the inverter is ready to operate, the output of the operation ready signal (RY) is ON. (It is also ON during inverter running.)
- When the output frequency of the inverter rises to or above *Pr. 13 Starting frequency*, the output of the inverter running signal (RUN) is turned ON. During an inverter stop or DC injection brake operation, the output is OFF.
- When using the RY and RUN signals, assign functions to *Pr. 190 to Pr. 192, Pr. 313 to Pr. 315 (output terminal selection function)* referring to the table below.

Output Signal	Pr. 190 to Pr. 192, Pr. 313 to Pr. 315 Setting	
	Positive logic	Negative logic
RY	11	111
RUN	0	100

Inverter Status / Output signal	Resetting	24V external power supplied (EV displayed on the operation panel)	Start Signal OFF (during stop)	Start Signal ON (during stop)	Start Signal ON (during operation)	Under DC Injection Brake	Output shutoff *2	Automatic Restart after Instantaneous Power Failure		
								Coasting		Restarting
								Start signal ON	Start signal OFF	
RY	OFF	OFF	ON	ON	ON	ON	OFF	ON *1	ON	
RUN	OFF	OFF	OFF	OFF	ON	OFF	OFF	OFF	ON	

*1 This signal turns OFF during power failure or undervoltage.

*2 Output is shutoff under conditions such as a fault occurrence, MRS signal ON, and the safety stop operation.



REMARKS

- The RUN signal (positive logic) is assigned to the terminal Y0 in the initial setting.

(3) Fault output signal (ALM signal)

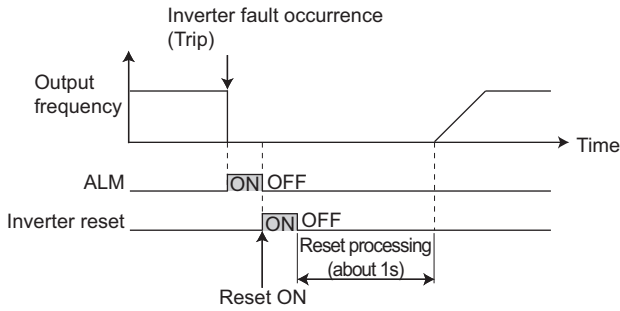

- If the inverter comes to trip, the ALM signal is output.

REMARKS

- The ALM signal is initially assigned to a virtual terminal of CC-Link communication. To assign the ALM signal to the terminal Y0 or another virtual terminal of CC-Link communication, set "99 (positive logic)" or "199 (negative logic)" in one of *Pr. 190 to Pr. 192* and *Pr. 313 to Pr. 315 (output terminal function selection)*.
- Refer to page 234 for the inverter fault description.

(4) Fault output 3 (power-off signal) (Y91 signal)

- The Y91 signal is output at occurrence of a fault attributable to the failure of the inverter circuit or a fault caused by a wiring mistake.
- For the Y91 signal, assign the function to the terminal Y0 or a virtual terminal of CC-Link communication by setting "91 (positive logic) or 191 (negative logic)" in one of *Pr. 190 to Pr. 192* and *Pr. 313 to Pr. 315 (output terminal function selection)*.
- The following table indicates the faults that will output the Y91 signal. (Refer to page 233 for the fault description.)

Operation Panel Indication		Name
E. bE	E. BE	Brake transistor alarm detection
E. GF	E.GF	Output side earth (ground) fault overcurrent
E. LF	E.LF	Output phase loss
E. PE	E.PE	Parameter storage device fault
E.PE2	E.PE2	Internal board fault
E. 5/ E. 6/ E. 7/ E.CPU	E. 5/ E. 6/ E. 7/ E.CPU	CPU fault
E.IOH	E.IOH	Inrush current limit circuit fault

REMARKS

- At occurrence of output side earth (ground) fault overcurrent (E.GF), overcurrent trip during acceleration (E.OC1) may be displayed. At this time, the Y91 signal is output.



Parameters referred to

Pr. 13 Starting frequency Refer to page 138

5.13.4 Detection of output frequency (SU, FU signal, Pr. 41 to Pr. 43)

The inverter output frequency is detected and output at the output signals.

Parameter Number	Name	Initial Value	Setting Range	Description
41	Up-to-frequency sensitivity	10%	0 to 100%	Level where the SU signal turns ON.
42	Output frequency detection	6Hz	0 to 400Hz	Frequency where the FU signal turns ON.
43	Output frequency detection for reverse rotation	9999	0 to 400Hz	Frequency where the FU signal turns ON in reverse rotation.
			9999	Same as Pr. 42 setting

The above parameters can be set when Pr. 160 User group read selection = "0". (Refer to page 197)

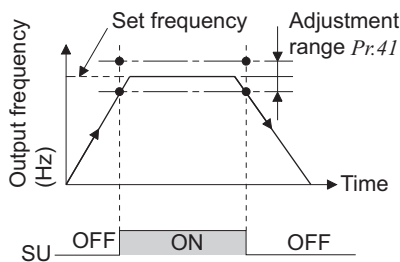

(1) Up-to-frequency sensitivity (SU signal, Pr. 41)

- When the output frequency reaches the set frequency, the up-to-frequency signal (SU) is output.
- The Pr. 41 value can be adjusted within the range 0% to $\pm 100\%$ on the assumption that the set frequency is 100%.
- This parameter can be used to ensure that the running frequency has been reached to provide the operation start signal etc. for related equipment.
- To assign the SU signal to the terminal Y0 or a virtual terminal of CC-Link communication, set "1 (positive logic) or 101 (negative logic)" in one of Pr. 190 to Pr. 192 and Pr. 313 to Pr. 315 (output terminal function selection).

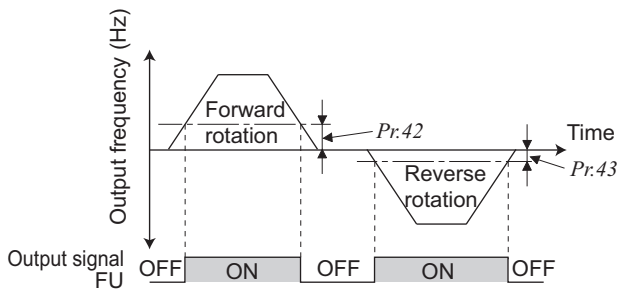

(2) Output frequency detection (FU signal, Pr. 42, Pr. 43)

- The output frequency detection signal (FU) is output when the output frequency reaches or exceeds the Pr. 42 setting.
- This function can be used for electromagnetic brake operation, open signal, etc.
- Frequency detection that is dedicated to reverse operation can be set by setting detection frequency to Pr. 43. This function is effective for switching the timing of electromagnetic brake operation between forward rotation (rise) and reverse rotation (fall) during vertical lift operation, etc.
- When Pr. 43 \neq "9999", the Pr. 42 setting is used for forward rotation and the Pr. 43 setting is used for reverse rotation.



REMARKS

- The FU signal is initially assigned to a virtual terminal of CC-Link communication. To assign the signal to the terminal Y0 or another virtual terminal of CC-Link communication, set "4 (positive logic) or 104 (negative logic)" in one of Pr. 190 to Pr. 192 and Pr. 313 to Pr. 315 (output terminal function selection).
- All signals are OFF during DC injection brake.
- The output frequency to be compared with the set frequency is the output frequency before slip compensation is performed.



NOTE

- Changing the assignment of the terminal Y0 or a virtual terminal of CC-Link communication with one of Pr. 190 to Pr. 192, and Pr. 313 to Pr. 315 (output terminal function selection) may affect other functions. Set parameters after confirming the function of the terminal Y0 and virtual terminals.



Parameters referred to

Pr. 190 to Pr. 192, Pr. 313 to Pr. 315 (output terminal function selection) (Refer to page 167)

5.13.5 Output current detection function (Y12 signal, Y13 signal, Pr. 150 to Pr. 153)

The output current during inverter operation can be detected and output to terminal Y0 or a virtual terminal of CC-Link communication.

Parameter Number	Name	Initial Value	Setting Range	Description
150	Output current detection level	150%	0 to 200%	100% is the rated inverter current.
151	Output current detection signal delay time	0s	0 to 10s	Output current detection period. The time from when the output current has risen above the setting until the output current detection signal (Y12) is output.
152	Zero current detection level	5%	0 to 200%	The rated inverter current is assumed to be 100%.
153	Zero current detection time	0.5s	0 to 1s	Period from when the output current drops below the Pr. 152 value until the zero current detection signal (Y13) is output.

The above parameters can be set when Pr. 160 User group read selection = "0". (Refer to page 197)

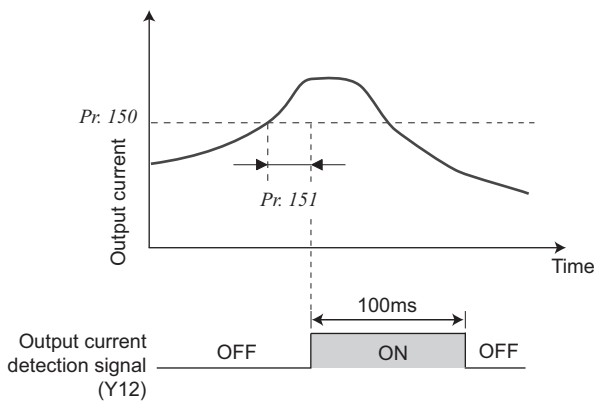

(1) Output current detection (Y12 signal, Pr. 150, Pr. 151)

- The output current detection function can be used for excessive torque detection, etc.
- If the output current remains higher than the Pr. 150 setting during inverter operation for the time set in Pr. 151 or longer, the output current detection signal (Y12) is output from the terminal Y0 or a virtual terminal of CC-Link communication.
- When the Y12 signal turns ON, the ON state is held for approximately 100ms.
- To assign the Y12 signal to the terminal Y0 or a virtual terminal of CC-Link communication, set "12 (positive logic) or 112 (negative logic)" in one of Pr. 190 to Pr. 192 and Pr. 313 to Pr. 315 (output terminal function selection).

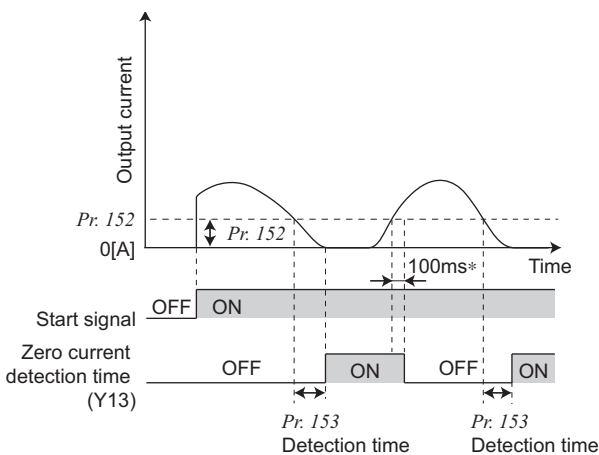

(2) Zero current detection (Y13 signal, Pr. 152, Pr. 153)

- If the output current remains lower than the Pr. 152 setting during inverter operation for longer than the time set in Pr. 153, the zero current detection (Y13) signal is output from the inverter's open collector or relay output terminal.
- When the inverter's output current falls to "0", torque will not be generated. This may cause a drop due to gravity when the inverter is used in vertical lift application. To prevent this, the Y13 signal, which closes the mechanical brake at "0" output current, can be output from the terminal Y0 or a virtual terminal of CC-Link communication.
- To assign the Y13 signal to the terminal Y0 or a virtual terminal of CC-Link communication, set "13 (positive logic) or 113 (negative logic)" in one of Pr.190 to Pr.192 and Pr.313 to Pr.315 (output terminal function selection).

* The zero current detection signal (Y13) holds the signal for approximately 100ms once turned ON.

REMARKS

- This function is also valid during execution of the offline auto tuning.
 - The response time of Y12 and Y13 signals is approximately 0.1s. Note that the response time changes according to the load condition.
- When Pr. 152 = "0", detection is disabled.





NOTE

- Changing the assignment of the terminal Y0 or a virtual terminal of CC-Link communication with one of *Pr. 190 to Pr. 192*, and *Pr. 313 to Pr. 315 (output terminal function selection)* may affect other functions. Set parameters after confirming the function of the terminal Y0 and virtual terminals.



CAUTION

-  The zero current detection level setting should not be too low, and the zero current detection time setting not too long. Otherwise, the detection signal may not be output when torque is not generated at a low output current.
-  To prevent the machine and equipment from resulting in hazardous conditions detection signal, install a safety backup such as an emergency brake even the zero current detection function is set valid.



Parameters referred to

Offline auto tuning  Refer to page 146

Pr. 190 to Pr. 192, Pr. 313 to Pr. 315 (output terminal function selection)  Refer to page 167

5.13.6 Remote output selection (REM signal, Pr. 495, Pr. 496)

You can utilize the ON/OFF of the inverter's output signals instead of the remote output terminal of the programmable logic controller.

Parameter Number	Name	Initial Value	Setting Range	Description	
495	Remote output selection	0	0	Remote output data clear at powering OFF	Remote output data is cleared during an inverter reset
			1	Remote output data retention at powering OFF	
			10	Remote output data clear at powering OFF	Remote output data is retained during an inverter reset
			11	Remote output data retention at powering OFF	
496*	Remote output data 1	0	0 to 4095	Refer to the following diagram.	

The above parameters can be set when Pr. 160 User group read selection = "0". (Refer to page 197)

* This parameter allows its setting to be changed during operation in any operation mode even if "0" (initial value) is set in Pr. 77 Parameter write selection.

<Remote output data>

Pr. 496

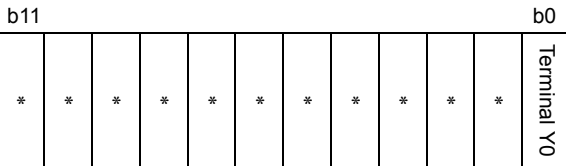

* Any

- The output terminal (Y0) can be turned ON/OFF depending on the Pr. 496 setting. The remote output selection can be controlled ON/OFF by CC-Link communication.
- To assign the remote output (REM) signal to the terminal Y0, set "96 (positive logic) or 196 (negative logic)" in Pr.190 RX2 (terminal Y0) function selection.
- When you refer to the diagram on the left and set 1 to the terminal bit (terminal Y0 where the REM signal has been assigned) of Pr. 496, the terminal Y0 turns ON (OFF for negative logic). By setting 0, the terminal Y0 turns OFF (ON for negative logic).

Example: When "96 (positive logic)" is set in Pr. 190 RX2 (terminal Y0) function selection and "1" (H01) is set in Pr. 496, the terminal Y0 turns ON.

ON/OFF example for positive logic

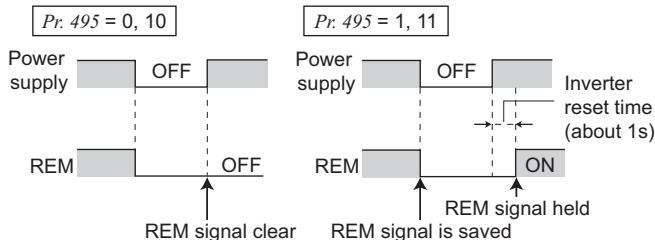

- When Pr. 495 = "0 (initial value), 10", performing a power ON reset (including a power failure) clears the REM signal output. (The ON/OFF status of the terminal Y0 is as set in Pr. 190.) The Pr. 496 setting is also "0". When Pr. 495 = "1, 11", the remote output data before power OFF is stored into the EEPROM, so the signal output at power recovery is the same as before power OFF. (See the chart on the left) However, it is not stored when the inverter is reset (reset request via CC-Link communication).
- When Pr. 495 = "10 or 11," the signal before the reset is held even during an inverter reset.

Signal condition during a reset

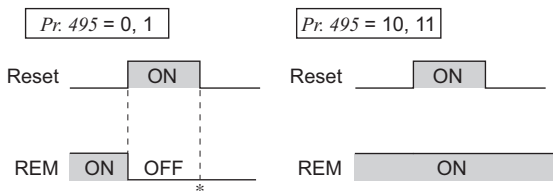

* When Pr. 495 = "1," the signal condition saved in EEPROM (condition of the last power OFF) is applied.

REMARKS

- The output terminal where the REM signal is not assigned using any of Pr. 190 does not turn ON/OFF if 0/1 is set to the terminal bit of Pr. 496. (It turns ON/OFF with the assigned function.)



Parameters referred to

Pr. 190 RX2 (terminal Y0) function selection Refer to page 167

5.14 Monitor display and monitor output signal

Purpose	Parameter that should be Set		Refer to Page
Display motor speed Set speed	Speed display and speed setting	Pr. 37	175
Change operation panel monitor display data	Operation panel main display data selection Cumulative monitor clear	Pr. 52, Pr. 170, Pr. 171, Pr. 268, Pr. 563, Pr. 564	176

5.14.1 Speed display and speed setting (Pr. 37)

The monitor display and frequency setting of the operation panel can be changed to the machine speed.

Parameter Number	Name	Initial Value	Setting Range	Description
37	Speed display	0	0	Frequency display, setting
			0.01 to 9998*	Machine speed at 60Hz.

The above parameters can be set when Pr. 160 User group read selection = "0". (Refer to page 197)

* The maximum value of the setting range differs according to the Pr. 1 Maximum frequency (Pr. 18 High speed maximum frequency) and it can be calculated from the following formula.

$$\text{Maximum setting value of Pr. 37} < \frac{16777.215 \times 60 \text{ (Hz)}}{\text{Setting value of Pr. 1 (Pr. 18) (Hz)}}$$

Note that the maximum setting value of Pr. 37 is 9998 if the result of the above formula exceeds 9998.

- To display the machine speed, set in Pr. 37 the machine speed for 60Hz operation.
For example, when Pr. 37 = "1000", "1000" is displayed on the output frequency and set frequency monitor when the running frequency is 60Hz. When running frequency is 30Hz, "500" is displayed.

Pr. 37 Setting	Output Frequency Monitor	Set Frequency Monitor	Frequency Setting	Parameter Setting
0 (initial value)	Hz	Hz	Hz	Hz
0.01 to 9998	Machine speed *1	Machine speed *1	Machine speed *1	

*1 Machine speed conversion formula Pr. 37 × frequency/60Hz

*2 Hz is displayed in 0.01Hz increments and machine speed is in 0.001.

NOTE



- Under V/F control, the output frequency of the inverter is displayed in terms of synchronous speed, and therefore, displayed value = actual speed + motor slip. The display changes to the actual speed (estimated value calculated based on the motor slip) when Advanced magnetic flux vector control was selected or slip compensation was valid.
- Since the panel display of the operation panel is 4 digits in length, the monitor value of more than "9999" is displayed "----".
- While the machine speed is displayed on the monitor, values of other parameters related to speed (Pr. 1, etc.) are in frequency increments. Set other parameters (Pr. 1, etc) related to speed in increments of frequency.
- Due to the limitations on the resolution of the set frequency, the indication in the second decimal place may differ from the setting.

CAUTION

 Make sure that the running speed setting is correct.
Otherwise, the motor might run at extremely high speed, damaging the machine.



Parameters referred to

Pr. 1 Maximum frequency, Pr. 18 High speed maximum frequency  Refer to page 124

Pr. 52 DU/PU main display data selection  Refer to page 176

Pr. 800 Control method selection  Refer to page 112

5.14.2 Monitor display selection of operation panel

(Pr. 52, Pr. 170, Pr. 171, Pr. 268, Pr. 563, Pr. 564)

The monitor to be displayed on the main screen of the operation panel can be selected.

Parameter Number	Name	Initial Value	Setting Range	Description
52 *1	DU/PU main display data selection	0 (output frequency)	0, 5, 7 to 12, 14, 20, 23 to 25, 52 to 55, 61, 62, 100 *2	Select the monitor to be displayed on the operation panel. Refer to the following table for monitor description.
170	Watt-hour meter clear	9999	0	Set "0" to clear the watt-hour meter monitor.
			10	Sets the maximum value for the monitoring from communication to 9999kWh.
			9999	Sets the maximum value for the monitoring from communication to 65535kWh.
171	Operation hour meter clear	9999	0, 9999	Set "0" in the parameter to clear the operation time monitor. Setting 9999 does not clear.
268 *1	Monitor decimal digits selection	9999	0	Displayed as integral value
			1	Displayed in 0.1 increments.
			9999	No function
563	Energization time carrying-over times	0	0 to 65535 (reading only)	The numbers of cumulative energization time monitor exceeded 65535h is displayed. (Reading only)
564	Operating time carrying-over times	0	0 to 65535 (reading only)	The numbers of operation time monitor exceeded 65535h is displayed. (Reading only)

The above parameters can be set when Pr. 160 User group read selection = "0". (Refer to page 197)

*1 This parameter allows its setting to be changed during operation in any operation mode even if "0" (initial value) is set in Pr. 77 Parameter write selection.

*2 The setting values "56 and 57" are for manufacturer setting. Do not set.

(1) Monitor description list (Pr. 52)

- Set the monitor to be displayed on the operation panel in Pr. 52 DU/PU main display data selection.
- Refer to the following table and set the monitor to be displayed.

Types of Monitor	Increment	Pr. 52 Setting	Description
Output frequency	0.01Hz	0/100	Displays the inverter output frequency.
Output current	0.01A	0/100	Displays the inverter output current effective value.
Output voltage	0.1V	0/100	Displays the inverter output voltage.
Fault display	—	0/100	Displays 8 past faults individually.
Frequency setting value	0.01Hz	5	Displays the set frequency.
Motor torque	0.1%	7	Displays the motor torque in % on the assumption that the rated motor torque is 100%. (Displays 0% during V/F control)
Converter output voltage	0.1V	8	Displays the DC bus voltage value.
Regenerative brake duty	0.1%	9	Brake duty set in Pr. 30, Pr. 70
Electronic thermal relay function load factor	0.1%	10	Displays the thermal cumulative value on the assumption that the thermal operation level is 100% (Larger thermal between the motor thermal and transistor thermal). *4
Output current peak value	0.01A	11	Holds and displays the peak value of the output power monitor. (Cleared at every start)
Converter output voltage peak value	0.1V	12	Holds and displays the peak value of the DC bus voltage value. (Cleared at every start)
Output power	0.01kW	14	Displays the power on the inverter output side
Cumulative energization time *1	1h	20	Adds up and displays the energization time after inverter shipment. You can check the numbers of the monitor value exceeded 65535h with Pr. 563.
Actual operation time *1, *2	1h	23	Adds up and displays the inverter operation time. You can check the numbers of the monitor value exceeded 65535h with Pr. 564. Can be cleared by Pr. 171. (Refer to page 179)
Motor load factor	0.1%	24	Displays the output current value on the assumption that the inverter rated current value is 100%. Monitor value = output power monitor value/rated inverter current 100 [%]

Types of Monitor	Increment	Pr. 52 Setting	Description
Cumulative power *3	0.01kWh *5	25	Adds up and displays the power amount based on the output power monitor. Can be cleared by Pr. 170. (Refer to page 178)
PID set point	0.1%	52	Displays the set point, measured value and deviation during PID control (Refer to page 207 for details)
PID measured value	0.1%	53	
PID deviation	0.1%	54	
Inverter output terminal monitor	—	55	Displays the ON/OFF status of inverter's output terminals and virtual terminals of CC-Link communication (RX2, RX6, RX7).
Motor thermal load factor	0.1%	61	Displays the motor thermal heat cumulative value. (Motor overload trip (E.THM) at 100%)
Inverter thermal load factor	0.1%	62	Displays the transistor thermal heat cumulative value. (Inverter overload trip (E.THT) at 100%)
Cumulative power 2	0.01kWh	—	Adds up and displays the power amount based on the output power monitor (The monitor dedicated to CC-Link communication) This can be cleared by Pr. 170. (Refer to page 178)

- *1 The cumulative energization time and actual operation time are accumulated from 0 to 65535 hours, then cleared, and accumulated again from 0. When the operation panel is used, the time is displayed up to 65.53 (65530h) in the indication of 1h = 0.001, and thereafter, it is added up from 0.
- *2 Actual operation time is not accumulated when the cumulative operation time is less than 1h until turning OFF of the power supply.
- *3 Since the panel display of the operation panel is 4 digits in length, the monitor value of more than "9999" is displayed "----".
- *4 Larger thermal value between the motor thermal and transistor thermal is displayed.
A value other than 0% is displayed if the surrounding air temperature (heatsink temperature) is high even when the inverter is at a stop.
- *5 The increment is 1kWh during monitoring via CC-Link communication.

 **REMARKS**

- By setting "0" in Pr. 52, the monitoring of output speed to fault display can be selected in sequence by (SET).
- When the operation panel is used, the displayed units are Hz and A only and the others are not displayed.
- The monitor set in Pr. 52 is displayed in the third monitor position. However, change the output current monitor for the motor load factor.

Initial Value

* The monitor displayed at power ON is the first monitor. Display the monitor you want to display on the first monitor and hold down (SET) for 1s. (To return to the output frequency monitor, hold down (SET) for 1s after displaying the output frequency monitor.)

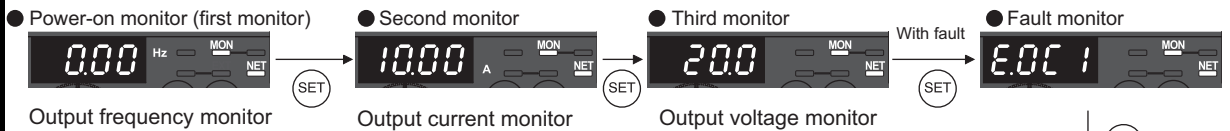

Example) When Pr. 52 is set to "20" (cumulative energization time), the monitor is displayed on the operation panel as described below.

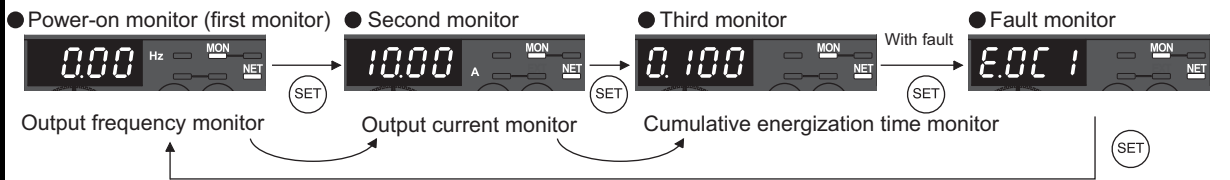

Monitor display and monitor output signal

(2) Display set frequency during stop (Pr. 52)

- When "100" is set in Pr. 52, the set frequency and output frequency are displayed during stop and operation respectively. (LED of Hz flickers during stop and is lit during operation.)

	Pr. 52		
	0	100	
	During running/stop	During stop	During running
Output frequency	Output frequency	Set frequency*	Output frequency
Output current	Output current		
Output voltage	Output voltage		
Fault display	Fault display		

* The set frequency displayed indicates the frequency to be output when the start command is ON. Different from the frequency setting displayed when Pr. 52 = "5", the value based on maximum/minimum frequency and frequency jump is displayed.

REMARKS

- During an error, the output frequency at error occurrence appears.
- During MRS signal is ON, the values displayed are the same as during a stop.
- During offline auto tuning, the tuning status monitor has priority.

(3) Operation panel I/O terminal monitor (Pr. 52)

- Set Pr. 52 = "55" to monitor the statuses of the output terminals and virtual terminals of CC-Link communication (RX2, RX6, RX7) on operation panel.
- The I/O terminal monitor is displayed on the third monitor.
- The LEDs are ON when the RX2 (terminal Y0), RX6 and RX7 are ON, and the LEDs are OFF when the terminals are OFF. The center line of LED is always ON.

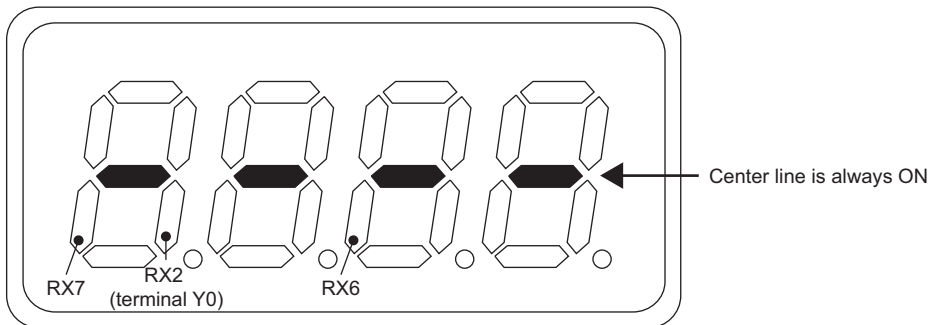

(4) Cumulative power/Cumulative power 2 monitor and clear (Pr. 170)

- Monitored output power is accumulated and updated in 1h increments for the cumulative power monitor (Pr. 52 = "25") and the cumulative power monitor 2 (dedicated to CC-Link communication).
- The operation panel, CC-Link communication display increments and display ranges are as indicated below.

Operation Panel *		CC-Link Communication			
Range	Cumulative power monitor increment	Range		Cumulative power monitor increment	Cumulative power 2 monitor increment
		Pr. 170 = 10	Pr. 170 = 9999		
0 to 99.99kWh	0.01kWh	0 to 9999kWh	0 to 65535kWh (initial value)	1kWh	0.01kWh
100.0 to 999.9kWh	0.1kWh				
1000 to 9999kWh	1kWh				

* Power is measured in the range 0 to 9999.99kWh, and displayed in 4 digits.

When the monitor value exceeds "99.99", a carry occurs, e.g. "100.0", so the value is displayed in 0.1kWh increments.

- Writing "0" in Pr. 170 clears the cumulative power monitor/Cumulative power 2 monitor.

REMARKS

- If "0" is written to Pr. 170 and Pr. 170 is read again, "9999" or "10" is displayed.

(5) Cumulative energization time and actual operation time monitor (Pr. 171, Pr. 563, Pr. 564)

- Cumulative energization time monitor (Pr. 52 = "20") accumulates energization time from shipment of the inverter every one hour.
- On the actual operation time monitor (Pr. 52 = "23"), the inverter running time is added up every hour. (Time is not added up during a stop.)
- If the monitored value exceeds 65535, it is added up from 0. You can check the numbers of cumulative energization time monitor exceeded 65535h with Pr. 563 and the numbers of actual operation time monitor exceeded 65535h with Pr. 564.
- Writing "0" to Pr. 171 clears the cumulative power monitor. (The cumulative time monitor can not be cleared.)

 **REMARKS**

- The cumulative energization time does not increase if the power is ON for less than an hour.
- The actual operation time does not increase if the cumulative running time during power-ON status is less than an hour.
- If "0" is written to Pr. 171 and Pr. 171 is read again, "9999" is always displayed. Setting "9999" does not clear the actual operation time meter.

(6) You can select the decimal digits of the monitor (Pr. 268)



- As the operation panel display is 4 digits long, the decimal places may vary at analog input, etc. The decimal places can be hidden by selecting the decimal digits.
- In such a case, the decimal digits can be selected by Pr. 268.

Pr. 268 Setting	Description
9999 (initial value)	No function
0	For the first or second decimal places (0.1 increments or 0.01 increments) of the monitor, numbers in the first decimal place and smaller are rounded to display an integral value (1 increments). The monitor value smaller than 0.99 is displayed as 0.
1	When 2 decimal places (0.01 increments) are monitored, the 0.01 decimal place is dropped and the monitor displays the first decimal place (0.1 increments). The monitored digits in 1 increments are displayed as they are.

 **REMARKS**

- The number of display digits on the cumulative energization time (Pr. 52 = "20"), actual operation time (Pr. 52 = "23"), and cumulative power (Pr. 52 = "25") does not change.

 **Parameters referred to**

- Pr. 30 Regenerative function selection, Pr. 70 Special regenerative brake duty  Refer to page 155
- Pr. 37 Speed display  Refer to page 175

5.15 Operation selection at power failure and instantaneous power failure

Purpose	Parameter that should be Set		Refer to Page
At instantaneous power failure occurrence, restart inverter without stopping motor	Automatic restart operation after instantaneous power failure/flying start	Pr. 57, Pr. 58, Pr. 96, Pr. 162, Pr. 165, Pr. 298, Pr. 299, Pr. 611	180
When undervoltage or a power failure occurs, the inverter can be decelerated to a stop.	Power failure-time deceleration-to-stop function	Pr. 261	186

5.15.1 Automatic restart after instantaneous power failure/flying start (Pr. 57, Pr. 58, Pr. 96, Pr. 162, Pr. 165, Pr. 298, Pr. 299, Pr. 611)

You can restart the inverter without stopping the motor in the following cases:

- When power comes back on after an instantaneous power failure
- When motor is coasting at start

Parameter Number	Name	Initial Value	Setting Range	Description
57	Restart coasting time	9999	0	1.5K or lower ... 1s 2.2K to 7.5K 2s 11K or higher... 3s The above times are coasting time.
			0.1 to 5s	Waiting time for inverter-triggered restart after an instantaneous power failure.
			9999	No restart
58	Restart cushion time	1s	0 to 60s	Voltage starting time at restart.
96	Auto tuning setting/status	0	0	Offline auto tuning is not performed
			1	Advanced magnetic flux vector control Offline auto tuning is performed without motor running (all motor constants) (Refer to page 114)
			11	For General-purpose magnetic flux vector control Offline auto tuning is performed without motor running (motor constants (R1) only) (Refer to page 117)
			21	Offline auto tuning (tuning performed without motor running) for V/F control and automatic restart after instantaneous power failure (with frequency search)
162	Automatic restart after instantaneous power failure selection	1	0	With frequency search
			1	Without frequency search (reduced voltage system)
			10	Frequency search at every start
			11	Reduced voltage at every start
165	Stall prevention operation level for restart	150%	0 to 200%	Considers the rated inverter current as 100% and sets the stall prevention operation level during restart operation.
298	Frequency search gain	9999	0 to 32767	When offline auto tuning is performed under V/F control, frequency search gain necessary for frequency search for automatic restart after instantaneous power failure is set as well as the motor constants (R1).
			9999	Uses the Mitsubishi motor (SF-JR, SF-HR, SF-JRCA, SF-HRCA) constants
299	Rotation direction detection selection at restarting	0	0	Without rotation direction detection
			1	With rotation direction detection
			9999	When Pr: 78 = 0, With rotation direction detection When Pr: 78 = 1, 2 Without rotation direction detection
611	Acceleration time at a restart	9999	0 to 3600s	Acceleration time to reach Pr. 20 Acceleration/deceleration reference frequency at a restart.
			9999	Acceleration time for restart is the normal acceleration time (e.g. Pr. 7)

The above parameters can be set when Pr. 160 User group read selection = "0". (Refer to page 197)

When Pr. 162 = 1, 11 (without frequency search)

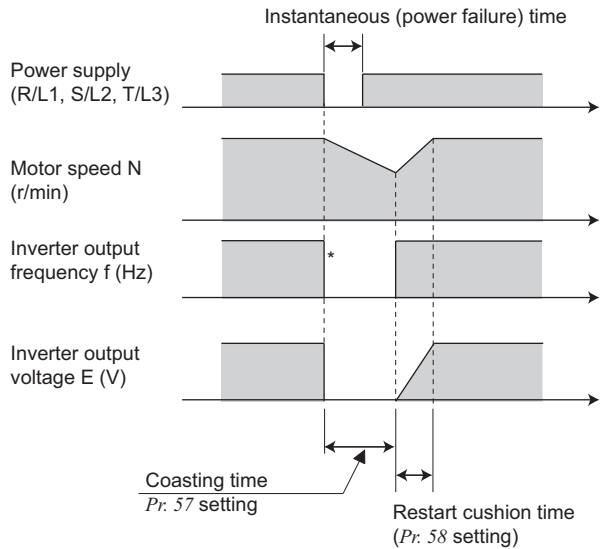

* The output shut off timing differs according to the load condition.

When Pr. 162 = 0, 10 (with frequency search)

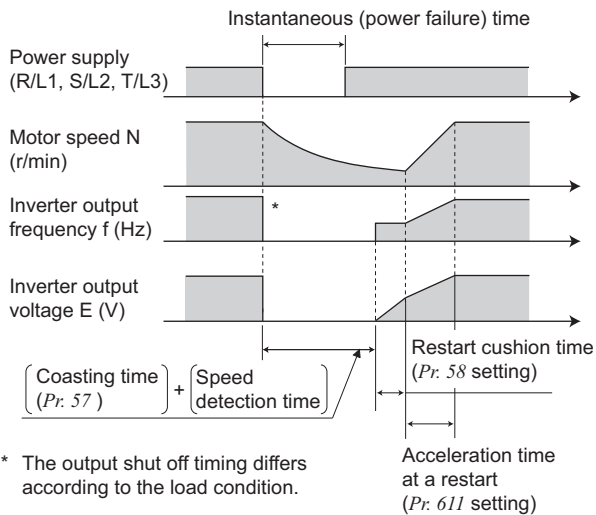

* The output shut off timing differs according to the load condition.

(1) Automatic restart operation selection

(Pr. 162, Pr. 299)

● Without frequency search

When Pr. 162 = "1 (initial value)" or "11", automatic restart operation is performed in a reduced voltage system, where the voltage is gradually risen with the output frequency unchanged from prior to an instantaneous power failure independently of the coasting speed of the motor.

REMARKS

- This system stores the output frequency and rotation direction prior to an instantaneous power failure and restart using the stored value. Therefore, if the instantaneous power failure time exceeds 0.2s and the stored value cannot be retained, the inverter starts at Pr. 13 Starting frequency (initial value = 0.5Hz) in the starting direction upon power restoration.

● With frequency search

When "0 or 10" is set in Pr. 162, the inverter smoothly starts after detecting the motor speed upon power restoration. (The motor capacity should be equal to or one rank lower than the inverter capacity)

When using the frequency search, perform offline auto tuning.

(Refer to page 146 for Advanced magnetic flux vector control, General-purpose magnetic flux vector control and page 182 for V/F control.)

- During reverse rotation, the inverter can be restarted smoothly as the direction of rotation is detected.
- You can select whether to make rotation direction detection or not with Pr. 299 Rotation direction detection selection at restarting.

When capacities of the motor and inverter differ, set "0" (without rotation direction detection) in Pr. 299.

Pr. 299 Setting	Pr. 78 Setting		
	0	1	2
9999	○	×	×
0 (initial value)	×	×	×
1	○	○	○

○: the rotation direction is detected.

×: the rotation direction is not detected.

REMARKS

- Speed detection time (frequency search) changes according to the motor speed. (maximum 100ms)
- When the inverter capacity is two rank or more larger than the motor capacity, the inverter may not start due to overcurrent trip (E.OC□).
- If two or more motors are connected to one inverter, the function does not operate properly. (The inverter does not start smoothly.)
- When reverse rotation is detected when Pr. 78 = "1" (reverse rotation disabled), the rotation direction is changed to forward rotation after decelerates in reverse rotation when the start command is forward rotation. The inverter will not start when the start command is reverse rotation.



NOTE

- When automatic restart operation after instantaneous power failure is activated while the motor is running at a low speed (less than 10Hz), the motor restarts in the direction prior to instantaneous power failure without detecting the rotation direction (Pr. 299 Rotation direction detection selection at restarting = "1").
- If the frequency search result exceeds the set frequency, the output frequency is limited at the set frequency.
- When the wiring length exceeds 100m, select without frequency search (Pr. 162 = "1, 11").

● Restart operation at every start

When *Pr. 162* = "10 or 11", automatic restart operation is also performed every start, in addition to the automatic restart after instantaneous power failure. When *Pr. 162* = "0", automatic restart operation is performed at the first start after power supply ON, but not performed at the second time or later.

(2) Restart coasting time (*Pr. 57*)

- Coasting time is the time from when the motor speed is detected until automatic restart control is started.
- Set *Pr. 57* to "0" to perform automatic restart operation.

The coasting time is automatically set to the value below. Generally this setting will pose no problems.

1.5K or lower.... 1s

2.2K to 7.5K..... 2s

11K or higher ... 3s

- Operation may not be performed well depending on the magnitude of the moment of inertia (J) of the load or running frequency. Adjust the coasting time between 0.1s and 5s according to the load specifications.

(3) Restart cushion time (*Pr. 58*)

- Cushion time is the length of time taken to raise the voltage appropriate to detected motor speed (output frequency prior to instantaneous power failure when *Pr. 162* = "1, 11") from 0V.
- Normally the initial value need not be changed for operation, but adjust it according to the magnitude of the moment of inertia (J) of the load or torque.

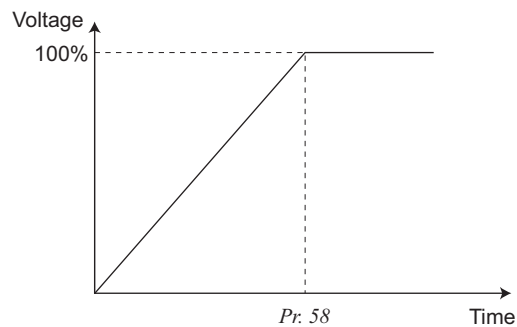

(4) Automatic restart operation adjustment (*Pr. 165, Pr. 611*)

- Using *Pr. 165*, you can set the stall prevention operation level at a restart.
- Using *Pr. 611*, you can set the acceleration time until *Pr.20 Acceleration/deceleration reference frequency* is reached when automatic restart operation is performed besides the normal acceleration time.

REMARKS

- If the *Pr. 21 Acceleration/deceleration time increments* is changed, the setting increments of *Pr. 611* remain unchanged.

(5) Frequency search gain (*Pr. 298*), offline auto tuning (*Pr. 96*)

- When automatic restart after instantaneous power failure operation (with frequency search) is valid at V/F control, perform offline auto tuning.
- Perform offline auto tuning during V/F control in the following order to set *Pr. 298 Frequency search gain* automatically. (Refer to page 146 during Advanced magnetic flux vector control and General-purpose magnetic flux vector control.)

●Before performing offline auto tuning

Check the following before performing offline auto tuning.

- The inverter is under V/F control
- A motor should be connected. Note that the motor should be at a stop at a tuning start.
- The motor capacity should be equal to or one rank lower than the inverter capacity. (note that the capacity is 0.1kW or more)
- A high-slip motor, high-speed motor and special motor cannot be tuned. (The maximum frequency is 120Hz.)
- Even if tuning is performed without motor running (*Pr. 96 Auto tuning setting/status* = "21"), the motor may run slightly. Therefore, fix the motor securely with a mechanical brake, or before tuning, make sure that there will be no problem in safety if the motor runs (caution is required especially in vertical lift applications). Note that tuning performance is unaffected even if the motor runs slightly.
- Offline auto tuning will not be performed properly if it is performed with a surge voltage suppression filter (FR-ASF-H, FR-BMF-H) connected between the inverter and motor. Remove it before starting tuning.

●Setting

- 1) Set "21" in *Pr. 96 Auto tuning setting/status*.

Tuning is performed without motor running.

It takes approximately 9s * until tuning is completed.

(Excitation noise is produced during tuning.)

*Tuning time differs according to the inverter capacity and motor type.

- 2) Set the rated motor current (initial value is rated inverter current) in *Pr. 9 Electronic thermal O/L relay*. (Refer to page 142)
- 3) Set *Pr. 71 Applied motor* according to the motor used.

Motor	Pr.71 Setting *1	
Mitsubishi standard motor Mitsubishi high efficiency motor	SF-JR	3
	SF-JR 4P 1.5kW or less	23
	SF-HR	43
	Others	3
Mitsubishi constant-torque motor	SF-JRCA 4P	13
	SF-HRCA	53
	Others (SF-JRC, etc.)	13
Other manufacturer's standard motor	—	3
Other manufacturer's constant torque motor	—	13

*1 Refer to page 144, for other settings of *Pr. 71*.

●Execution of tuning



POINT

Before tuning, check the monitor display on the operation panel to confirm that the inverter is ready for tuning. (Refer to 2) below)

- 1) In the PU operation mode, press on the operation panel.





In the Network operation mode, turn on the start command via CC-Link communication. And tuning will start.



NOTE

- To end the tuning forcibly, input the MRS signal, command the inverter reset via CC-Link communication, or press on the operation panel. (Turning the start signal (STF signal or STR signal) OFF also ends tuning.)
- During offline auto tuning, only the following I/O signals are valid: (initial value)
 - Input signal MRS, STF, STR
 - Output signal RUN, ALM
- Since the RUN signal turns ON when tuning is started, caution is required especially when a sequence which releases a mechanical brake by the RUN signal has been designed.
- When executing offline auto tuning, input the run command after switching ON the main circuit power (R/L1, S/L2, T/L3) of the inverter.
- Do not perform ON/OFF switching of the second function selection signal (RT) during execution of offline auto tuning. Auto tuning is not executed properly.

2) Monitor is displayed on the operation panel during tuning as below.

	Operation Panel Indication
Pr. 96 setting	21
(1) Setting	
(2) Tuning in progress	
(3) Normal end	Flickering 
(4) Error end (when inverter protective function operation is activated)	

•Reference: Offline auto tuning time (when the initial value is set)

Offline Auto Tuning Setting	Time
Tune motor constants (R1) only (Pr. 96 = "21")	Approx. 9s (Tuning time differs according to the inverter capacity and motor type.)

- 3) When offline auto tuning ends, press  of the operation panel during PU operation. In the Network operation mode, turn OFF the start command via CC-Link communication. This operation resets the offline auto tuning and the operation panel monitor display returns to the normal indication. (Without this operation, next operation cannot be started.)

REMARKS

- Do not change the Pr. 96 setting after completion of tuning (23).
If the Pr. 96 setting is changed, tuning data is invalid.
If the Pr. 96 setting is changed, tuning must be performed again.
- 4) If offline auto tuning ended in error (see the table below), motor constants are not set. Perform an inverter reset and restart tuning.

Error Display	Error Cause	Remedy
8	Forced end	Set "21" in Pr. 96 and perform tuning again.
9	Inverter protective function operation	Make setting again.
91	Current limit (stall prevention) function was activated.	Set "1" in Pr. 156.
92	Converter output voltage reached 75% of rated value.	Check for fluctuation of power supply voltage.
93	Calculation error A motor is not connected.	Check the motor wiring and make setting again. Set the rated current of the motor in Pr. 9.

- 5) When tuning is ended forcibly by pressing  or turning OFF the start signal (STF or STR) during tuning, offline auto tuning does not end normally. (The motor constants have not been set.) Perform an inverter reset and restart tuning.
- 6) After the tuning completes, set Pr. 9 *Electronic thermal O/L relay* again for the motor with the rated power supply of 200/220V(400/440V) 60Hz. Set the rated motor current multiplied by 1.1 in Pr. 9.



NOTE

- The motor constants measured once in the offline auto tuning are stored as parameters and their data are held until the offline auto tuning is performed again.
- An instantaneous power failure occurring during tuning will result in a tuning error.
After power is restored, the inverter goes into the normal operation mode. Therefore, when STF (STR) signal is ON, the motor runs in the forward (reverse) rotation.
- Any alarm occurring during tuning is handled as in the ordinary mode. Note that if a fault retry has been set, retry is ignored.
- The set frequency monitor displayed during the offline auto tuning is 0Hz.
- The SU and FU signals are not output during a restart. They are output after the restart cushion time has elapsed.
- Automatic restart operation will also be performed after a reset or when a retry is made by the retry function.

 **CAUTION**

 When automatic restart after instantaneous power failure has been selected, the motor and machine will start suddenly (after the reset time has elapsed) after occurrence of an instantaneous power failure.







Stay away from the motor and machine.

When you have selected automatic restart after instantaneous power failure function, apply in easily visible places the CAUTION stickers supplied to the instruction manual (basic).

 When the start signal is turned OFF or  is pressed during the restart cushion time after instantaneous power failure, deceleration starts after Pr. 58 Restart cushion time has elapsed.



Parameters referred to

- Pr. 7 Acceleration time, Pr. 21 Acceleration/deceleration time increments  Refer to page 135
- Pr. 13 Starting frequency  Refer to page 138
- Pr. 65, Pr. 67 to Pr. 69 Retry function  Refer to page 188
- Pr. 71 Applied motor  Refer to page 144
- Pr. 78 Reverse rotation prevention selection  Refer to page 197
- Pr. 180 to Pr. 184 (input terminal function selection)  Refer to page 163
- Pr. 190 to Pr. 192, Pr. 313 to Pr. 315 (output terminal function selection)  Refer to page 167

5.15.2 Power-failure deceleration stop function (Pr. 261)

When a power failure or undervoltage occurs, the inverter can be decelerated to a stop or can be decelerated and re-accelerated to the set frequency.

Parameter Number	Name	Initial Value	Setting Range	Description
261	Power failure stop selection	0	0	Coasts to stop. When undervoltage or power failure occurs, the inverter output is shut off.
			1	When undervoltage or a power failure occurs, the inverter can be decelerated to a stop.
			2	When undervoltage or a power failure occurs, the inverter can be decelerated to a stop. If power is restored during a power failure, the inverter accelerates again.

The above parameters can be set when Pr. 160 User group read selection = "0". (Refer to page 197)

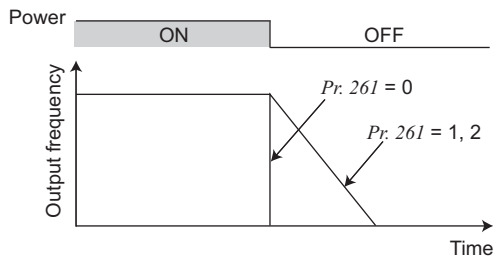

(1) Parameter setting

- When Pr. 261 is set to "1" or "2", the inverter decelerates to a stop if an undervoltage or power failure occurs.

(2) Operation outline of deceleration to stop at power failure

- When undervoltage or power failure has occurred, the output frequency is decreased and controlled so that the converter circuit (DC bus) voltage is constant and decreased to 0Hz to stop.

(3) Power failure stop function (Pr. 261 = "1")

- If power is restored during power failure deceleration, deceleration to a stop is continued and the inverter remains stopped. To restart, turn OFF the start signal once, then turn it ON again.

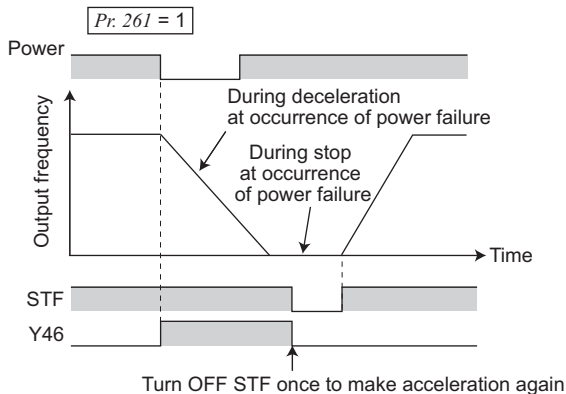

REMARKS

- When automatic restart after instantaneous power failure is selected (Pr. 57 ≠ "9999"), power failure stop function is invalid and automatic restart operation after instantaneous power failure is valid.
- Powering ON while a start signal (STF/STR) is being input via CC-Link communication does not start the motor if the power-failure deceleration stop function has been set valid (Pr. 261 = "1"). After switching ON the power, turn OFF the start signal once and then ON again to make a start.

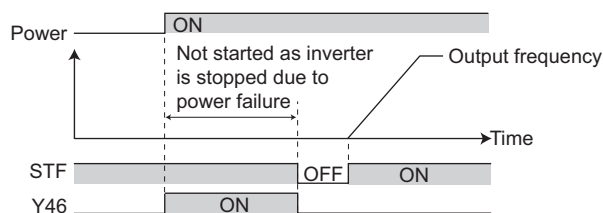

(4) Operation continuation at instantaneous power failure function (Pr. 261 = "2")

- When power is restored during deceleration after a power failure, the inverter accelerates back up to the set frequency.
- When this function is used in combination with the automatic restart after instantaneous power failure function (Pr. 57 ≠ "9999"), deceleration can be made at a power failure and acceleration can be made again after power restoration.

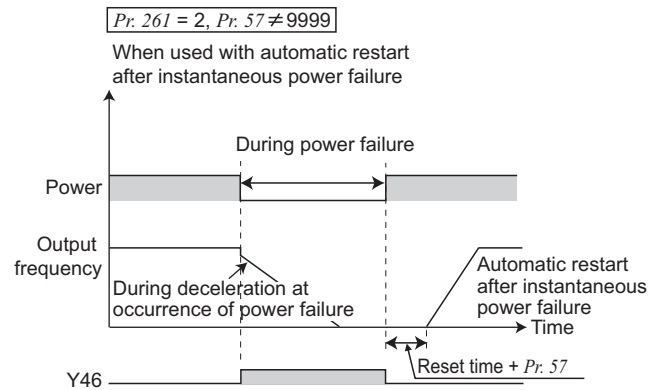
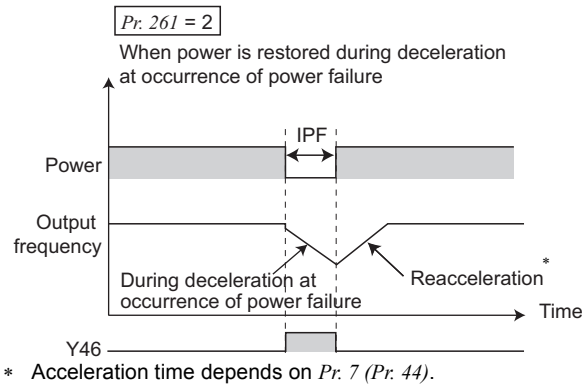

NOTE

- When operation continuation at instantaneous power failure function is used, keep the starting signal (STF/STR) ON even during instantaneous power failure. If the starting signal turns OFF during instantaneous power failure, the inverter decelerates according to the deceleration time setting, causing the motor to coast if enough regenerative energy is not obtained.

(5) Power failure deceleration signal (Y46 signal)

- The Y46 signal is ON during deceleration at an instantaneous power failure or during a stop after deceleration at an instantaneous power failure.
- After a power failure stop, the inverter can not start even if power is restored the start command is given. In this case, check the power failure deceleration signal (Y46 signal). (at occurrence of input phase loss (E.I.LF), etc.)
- To assign the Y46 signal to the terminal Y0 or a virtual terminal of CC-Link communication, set "46 (positive logic)" or "146 (negative logic)" in one of Pr.190 to Pr.192 and Pr.313 to Pr.315 (output terminal function selection).



REMARKS

- During a stop or trip, the power failure stop selection is not performed.



NOTE

- Changing the assignment of the terminal Y0 or a virtual terminal of CC-Link communication with one of Pr. 190 to Pr. 192, and Pr. 313 to Pr. 315 (output terminal function selection) may affect other functions. Set parameters after confirming the function of the terminal Y0 and virtual terminals.

CAUTION



Even if the power failure stop function is valid, some loads may cause the inverter to trip and the motor to coast.

The motor will coast if enough regenerative energy is not given from the motor to the inverter.



Parameters referred to

- Pr. 57 Restart coasting time Refer to page 180
- Pr. 190 to Pr. 192, Pr. 313 to Pr. 315 (output terminal function selection) Refer to page 167

5.16 Operation setting at fault occurrence

Purpose	Parameter that should be Set		Refer to Page
Recover by retry operation at fault occurrence	Retry operation	Pr. 65, Pr. 67 to Pr. 69	188
Do not output input/output phase failure alarm	Input/output phase failure protection selection	Pr. 251, Pr. 872	190
Detect an earth (ground) fault at start	Earth (ground) fault detection at start	Pr. 249	190

5.16.1 Retry function (Pr. 65, Pr. 67 to Pr. 69)

If a fault occurs, the inverter resets itself automatically to restart. You can also select the fault for a retry. When you have selected automatic restart after instantaneous power failure (*Pr. 57 Restart coasting time ≠ 9999*), restart operation is performed at the retry operation time which is the same of that of a power failure. (Refer to page 180 for the restart function.)

Parameter Number	Name	Initial Value	Setting Range	Description
65	Retry selection	0	0 to 5	A fault for retry can be selected. (Refer to the next page)
67	Number of retries at fault occurrence	0	0	No retry function
			1 to 10	Set the number of retries at fault occurrence. A fault output is not provided during retry operation.
			101 to 110	Set the number of retries at fault occurrence. (The setting value of minus 100 is the number of retries.) A fault output is provided during retry operation.
68	Retry waiting time	1s	0.1 to 360s	Set the waiting time from when an inverter fault occurs until a retry is made.
69	Retry count display erase	0	0	Clear the number of restarts succeeded by retry.

The above parameters can be set when *Pr. 160 User group read selection = "0"*. (Refer to page 197)

Retry success example

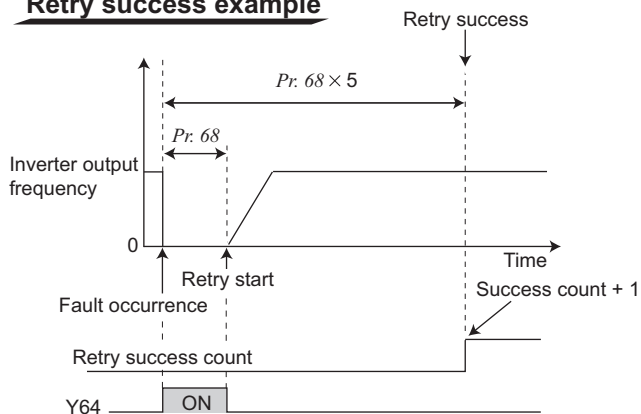

Retry failure example

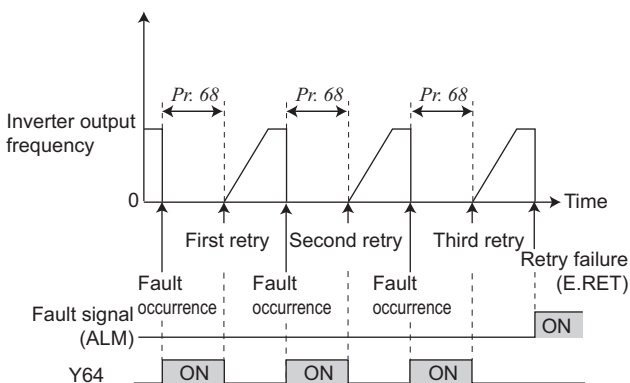

- Retry operation automatically resets a fault and restarts the inverter at the starting frequency when the time set in *Pr. 68* elapses after the inverter is tripped.
- Retry operation is performed by setting *Pr. 67* to any value other than "0". Set the number of retries at fault occurrence in *Pr. 67*.
- When retries fail consecutively more than the number of times set in *Pr. 67*, a retry count excess fault (E.RET) occurs, resulting in inverter trip. (Refer to retry failure example)
- Use *Pr. 68* to set the waiting time from when the inverter trips until a retry is made in the range 0.1 to 360s.
- Reading the *Pr. 69* value provides the cumulative number of successful restart times made by retry. The cumulative count in *Pr. 69* is increased by 1 when a retry is regarded as successful after normal operation continues without faults occurring for more than four times longer than the time set in *Pr. 68* after a retry start. (When retry is successful, cumulative number of retry failure is cleared.)
- Writing "0" to *Pr. 69* clears the cumulative count.
- During a retry, the Y64 signal is ON. To assign the Y64 signal to the terminal Y0 or a virtual terminal of CC-Link communication, set "64 (positive logic)" or "164 (negative logic)" in one of *Pr.190 to Pr.192* and *Pr.313 to Pr.315* (output terminal function selection).

- Using Pr. 65, you can select the fault that will cause a retry to be executed. No retry will be made for the fault not indicated. (Refer to page 234 for the fault description.)
 - indicates the faults selected for retry.

Fault for Retry	Pr. 65 Setting					
	0	1	2	3	4	5
E.OC1	●	●		●	●	●
E.OC2	●	●		●	●	
E.OC3	●	●		●	●	●
E.OV1	●		●	●	●	
E.OV2	●		●	●	●	
E.OV3	●		●	●	●	
E.THM	●					
E.THT	●					
E. BE	●				●	
E. GF	●				●	

Fault for Retry	Pr. 65 Setting					
	0	1	2	3	4	5
E.USB	●				●	
E.OLT	●				●	
E.OPT	●				●	
E.OP1	●				●	
E. PE	●				●	
E.MB4	●				●	
E.MB5	●				●	
E.MB6	●				●	
E.MB7	●				●	
E.ILF	●				●	



NOTE

- Changing the assignment of the terminal Y0 or a virtual terminal of CC-Link communication with one of Pr. 190 to Pr. 192, and Pr. 313 to Pr. 315 (output terminal function selection) may affect other functions. Set the parameters after confirming the function of the terminal Y0 and virtual terminals.
- The data stored as the error reset for retry is only that of the fault which occurred the first time.
- When an inverter fault is reset by the retry function at the retry time, the accumulated data of the electronic thermal relay function, regeneration brake duty etc. are not cleared. (Different from the power-ON reset.)
- Retry is not performed if E.PE (Parameter storage device fault) occurred at power ON.
- If a fault that is not selected for a retry occurs during retry operation (retry waiting time), the retry operation stops while the fault indication is still displayed.

 **CAUTION**

 When you have selected the retry function, stay away from the motor and machine when the inverter is tripped. They will start suddenly (after the reset time has elapsed) after the inverter trip.
When you have selected the retry function, apply in easily visible places the CAUTION stickers supplied.



Parameters referred to

Pr. 57 Restart coasting time  Refer to page 180

5.16.2 Input/output phase loss protection selection (Pr. 251, Pr. 872)

You can choose whether to make the input/output phase loss protection valid or invalid.

- Output phase loss protection is a function to stop the inverter output if one of the three phases (U, V, W) on the inverter's output side (load side) is lost.
- Input phase loss protection is a function to stop the inverter output if one of the three phases (R/L1, S/L2, T/L3) on the inverter's input side is lost.

Parameter Number	Name	Initial Value	Setting Range	Description
251	Output phase loss protection selection	1	0	Without output phase loss protection
			1	With output phase loss protection
872 *	Input phase loss protection selection	1	0	Without input phase loss protection
			1	With input phase loss protection

The above parameters can be set when Pr. 160 User group read selection = "0". (Refer to page 197)

* Available only for the three-phase power input model.

(1) Output phase loss protection selection (Pr. 251)

- If phase loss occurs during inverter running (except for during DC brake operation, or output frequency is 1Hz or less), output phase loss protection (E.LF) activates, and inverter trips.
- When Pr. 251 is set to "0", output phase loss protection (E.LF) becomes invalid.

(2) Input phase loss protection selection (Pr. 872)

- When Pr. 872 is set to "1", input phase loss protection (E.ILF) is provided if a phase loss of one phase among the three phases is detected for 1s continuously.



NOTE

- If an input phase loss continues for a long time, the converter section and capacitor lives of the inverter will be shorter.
- If the load is light or during a stop, lost phase cannot be detected because detection is performed based on the fluctuation of bus voltage. Large unbalanced phase-to-phase voltage of the three-phase power supply may also cause input phase loss protection (E.ILF).
- Phase loss can not be detected during regeneration load operation.

5.16.3 Earth (ground) fault detection at start (Pr. 249)

You can choose whether to make earth (ground) fault detection at start valid or invalid. Earth (Ground) fault detection is executed only right after the start signal is input to the inverter.

Protective function will not activate if an earth (ground) fault occurs during operation.

Parameter Number	Name	Initial Value	Setting Range	Description
249	Earth (ground) fault detection at start	0	0	Without earth (ground) fault detection
			1	With earth (ground) fault detection

The above parameters can be set when Pr. 160 User group read selection = "0". (Refer to page 197)



NOTE

- As detection is executed at start, output is delayed for approx. 20ms every start.
- If an earth (ground) fault is detected with "1" set in Pr. 249, output side earth (ground) fault overcurrent (E.GF) is detected and the inverter trips. (Refer to page 240)
- If the motor capacity is smaller than the inverter capacity of the 5.5K or higher, earth (ground) fault detection may not be provided.

5.17 Energy saving operation

Purpose	Parameter that should be Set		Refer to Page
Energy saving operation	Optimum excitation control	Pr. 60	191

5.17.1 Optimum excitation control (Pr. 60)

Without a fine parameter setting, the inverter automatically performs energy saving operation.
This operation is optimum for fan and pump applications

Parameter Number	Name	Initial Value	Setting Range	Description
60	Energy saving control selection	0	0	Normal operation mode
			9	Optimum excitation control mode

The above parameters can be set when Pr. 160 User group read selection = "0". (Refer to page 197)

- When "9" is set in Pr. 60, the inverter operates in the Optimum excitation control mode.
- The Optimum excitation control mode is a control system which controls excitation current to improve the motor efficiency to maximum and determines output voltage as an energy saving method.



REMARKS

- When the motor capacity is too small as compared to the inverter capacity or two or more motors are connected to one inverter, the energy saving effect is not expected.





NOTE

- When the Optimum excitation control mode is selected, deceleration time may be longer than the setting value. Since overvoltage alarm tends to occur as compared to the constant-torque load characteristics, set a longer deceleration time.
- Optimum excitation control functions only under V/F control. Optimum excitation control does not function under Advanced magnetic flux vector control and General-purpose magnetic flux vector control.
- Optimum excitation control will not be performed during an automatic restart after instantaneous power failure.
- Since output voltage is controlled by Optimum excitation control, output current may slightly increase.



Parameters referred to

Advanced magnetic flux vector control  Refer to page 114
General-purpose magnetic flux vector control  Refer to page 117
Pr. 57 Restart coasting time 

5.18 Motor noise, EMI measures, mechanical resonance

Purpose of Use	Parameter that should be Set		Refer to Page
Reduction of the motor noise Measures against EMI and leakage currents	Carrier frequency and Soft-PWM selection	Pr. 72, Pr. 240	192
Reduce mechanical resonance	Speed smoothing control	Pr. 653	193

5.18.1 PWM carrier frequency and soft-PWM control (Pr. 72, Pr. 240)

You can change the motor sound.

Parameter Number	Name	Initial Value	Setting Range	Description
72	PWM frequency selection	1	0 to 15	You can change the PWM carrier frequency. The setting is in [kHz]. Note that 0 indicates 0.7kHz and 15 indicates 14.5kHz.
240	Soft-PWM operation selection	1	0	Soft-PWM is invalid
			1	When Pr. 72 = "0 to 5", soft-PWM is valid.

The above parameters can be set when Pr.160 User group read selection = "0". (Refer to page 197)

The above parameters allow their settings to be changed during operation even if "0" (initial value) is set in Pr. 77 Parameter write selection.

(1) PWM carrier frequency changing (Pr. 72)

- You can change the PWM carrier frequency of the inverter.
- Changing the PWM carrier frequency produces an effect on avoiding the resonance frequency of a mechanical system or motor or on EMI measures or on leakage current reduction caused by the PWM switching.

(2) Soft-PWM control (Pr. 240)

- Soft-PWM control is a control method that changes the motor noise from a metallic tone into an unoffending complex tone.



NOTE

- Decreasing the PWM carrier frequency effect on EMI measures and on leakage current reduction, but increases motor noise.
- When PWM carrier frequency is set to 1kHz or less ($Pr.72 \leq 1$), fast response current limit may function prior to stall prevention operation due to increase in ripple currents, resulting in insufficient torque. In such case, set fast-response current limit operation invalid using Pr. 156 Stall prevention operation selection .
- When setting 2kHz or more in Pr. 72 to perform operation in the place where the surrounding air temperature exceeding 40°C, caution should be taken as the rated inverter current should be reduced. (Refer to page 266)



Parameters referred to

Pr. 156 Stall prevention operation selection  Refer to page 120

5.18.2 Speed smoothing control (Pr. 653)

Vibration due to mechanical resonance influences the inverter control, causing the output current (torque) unstable. In this case, the output current (torque) fluctuation can be reduced to ease vibration by changing the output frequency.

Parameter Number	Name	Initial Value	Setting Range	Description
653	Speed smoothing control	0	0 to 200%	Increase or decrease the value using 100% as reference to check an effect.

The above parameters can be set when Pr. 160 User group read selection = "0". (Refer to page 197)

(1) Control block diagram

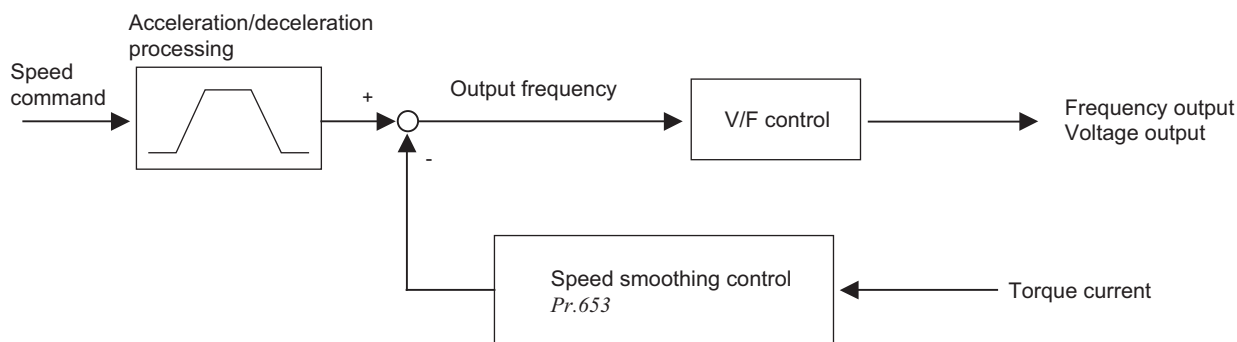

(2) Setting method

If vibration due to mechanical resonance occurs, set 100% in Pr: 653, run the inverter at the frequency which generates maximum vibration and check if the vibration will be reduced or not after several seconds.

If effect is not produced, gradually increase the Pr: 653 setting and check the effect repeatedly until the most effective value is set in Pr: 653.

If vibration becomes large by increasing the Pr: 653 setting, gradually decrease the Pr: 653 setting than 100% to check the effect in a similar manner.



NOTE

Depending on the machine, vibration may not be reduced enough or an effect may not be produced.

5.19 Misoperation prevention and parameter setting restriction

Purpose	Parameter that should be Set		Refer to Page
Limits reset function Stops from operation panel	Reset selection/disconnected PU detection/PU stop selection	Pr. 75	194
Prevention of parameter rewrite	Parameter write disable selection	Pr. 77	196
Prevention of reverse rotation of the motor	Reverse rotation prevention selection	Pr. 78	197
Displays necessary parameters	Display of applied parameters and user group function	Pr. 160, Pr. 172 to Pr. 174	197
Parameter restriction using password	Password function	Pr. 296, Pr. 297	199
Control of parameter write by communication	EEPROM write selection	Pr. 342	110



5.19.1 Reset selection/PU stop selection (Pr. 75)

You can select the reset input acceptance and operation panel stop function.

Parameter Number	Name	Initial Value	Setting Range	Description
75	Reset selection/PU stop selection	14	0 to 3, 14 to 17	For the initial value, reset always enabled, and with operation panel stop function are set.

• The above parameters can be set when Pr. 160 User group read selection = "0". (Refer to page 197)

• This parameter allows its setting to be changed during operation in any operation mode even if "0 (initial value) or "1" is set in Pr. 77 Parameter write selection. Also, if parameter (all) clear is executed, this setting will not return to the initial value.

Pr. 75 Setting	Reset Selection	PU Stop Selection
0, 2	Reset input is always enabled	Pressing  decelerates the motor to a stop only in the PU operation mode.
1, 3	Reset input is enabled only when the fault occurs.	
14(initial value), 16	Reset input is always enabled	Pressing  decelerates the motor to a stop in either of the PU or Network operation mode.
15, 17	Reset input is enabled only when the fault occurs.	

(1) Reset selection



- You can select the enable condition of reset function (reset command through CC-Link communication) input.
- When Pr. 75 is set to any of "1, 3, 15, 17", a reset can be input only when the inverter is tripped.



NOTE

- When the reset is input during operation, the motor coasts since the inverter being reset shuts off the output.
- When reset is performed, cumulative values of electronic thermal O/L relay, regenerative brake duty are cleared.
-  on the operation panel is only valid when the inverter is tripped, independently of the Pr. 75 setting.

(2) PU stop selection

- Set Pr. 75 = "14" to "17" to enable  on the operation panel to command emergency stop in PU and Network operation modes.
- When the inverter is stopped by the PU stop function, "PS" (PS) is displayed. A fault output is not provided.
- After the motor is stopped from the PU, it is necessary to perform PU stop (PS) reset to restart. PS reset can be made from the operation panel.
- PS reset can be also made by resetting the power or transmitting a reset command via CC-Link communication. The motor can restart after the PS reset.
- When Pr. 75 is set to any of "0 to 3", PU stop (PS display) is invalid, deceleration to a stop by  is valid only in the PU operation mode.





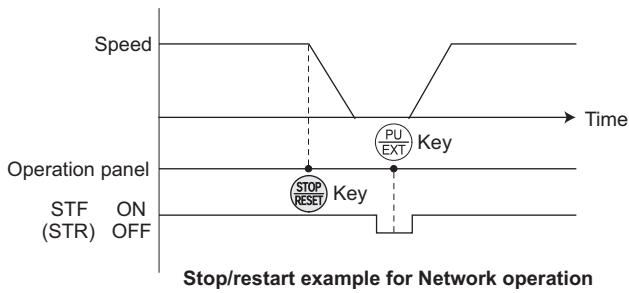

REMARKS

During operation in the PU operation mode through USB communication, the motor decelerates to stop (PU stop) when entered from the operation panel .

(3) How to restart the motor stopped by  input in the Network operation mode (PU stop (PS) reset method)



- 1) After completion of deceleration to a stop, switch OFF the STF or STR signal.
- 2) Press  to display  (PS reset)
- 3) Press  to return to .
- 4) Switch ON the STF or STR signal.

• The motor can be also restarted by resetting the power or transmitting a reset command via CC-Link communication.

 **REMARKS**

- If Pr. 250 Stop selection is set to other than "9999" to select coasting to a stop, the motor will not be coasted to a stop but decelerated to a stop by the PU stop function during CC-Link communication operation.

 **CAUTION**

 Do not reset the inverter while the start signal is being input.
Otherwise, the motor will start instantly after resetting, leading to potentially hazardous conditions.

 **Parameters referred to**

Pr. 250 Stop selection  Refer to page 157

5.19.2 Parameter write disable selection (Pr. 77)

You can select whether write to various parameters can be performed or not. Use this function to prevent parameter values from being rewritten by misoperation.

Parameter Number	Name	Initial Value	Setting Range	Description
77	Parameter write selection	0	0	Write is enabled only during a stop.
			1	Parameter can not be written.
			2	Parameter write is enabled in any operation mode regardless of operation status.

The above parameters can be set when *Pr. 160 User group read selection* = "0". (Refer to page 197)

Pr. 77 can be always set independently of the operation mode and operation status. It cannot be set via CC-Link communication.

(1) Write parameters only during stop (setting "0" initial value)

- Parameters can be written only during a stop in the PU operation mode.
- The shaded parameters in the parameter list (page 84) can always be written regardless of the operation mode and operating status. However, *Pr. 72 PWM frequency selection*, *Pr. 240 Soft-PWM operation selection*, and *Pr. 275 Stop-on contact excitation current low-speed multiplying factor* can be written when the inverter is running in the PU operation mode, but cannot be written in the Network operation mode.

(2) Inhibit parameter write (setting "1")

- Parameter write is not enabled.
(Read is enabled.)
- Parameter clear and all parameter clear cannot be performed, either.
- The parameters given on the right can be written if *Pr. 77* = "1". (The setting values of *Pr.77* and *Pr.79*, however, cannot be changed via CC-Link communication.)

Parameter Number	Name
22	Stall prevention operation level
75	Reset selection/PU stop selection
77	Parameter write selection
79	Operation mode selection
160	User group read selection
296	Password lock level
297	Password lock/unlock

(3) Write parameters during operation (setting "2")

- Parameters can always be written.
- The following parameters cannot be written when the inverter is running if *Pr. 77* = "2". Stop the inverter when changing their parameter settings.

Parameter Number	Name
23	Stall prevention operation level compensation factor at double speed
40	RUN key rotation direction selection
48	Second stall prevention operation current
60	Energy saving control selection
61	Reference current
66	Stall prevention operation reduction starting frequency
71	Applied motor
79	Operation mode selection
80	Motor capacity
81	Number of motor poles
82	Motor excitation current
83	Rated motor voltage
84	Rated motor frequency
90 to 94	(Motor constants)

Parameter Number	Name
96	Auto tuning setting/status
180 to 184	(input terminal function selection)
190 to 192	(output terminal function selection)
277	Stall prevention operation current switchover
292	Automatic acceleration/deceleration
293	Acceleration/deceleration separate selection
298	Frequency search gain
450	Second applied motor
541	Frequency command sign selection (CC-Link)
800	Control method selection
859	Torque current



Parameters referred to

Pr. 79 Operation mode selection Refer to page 103

5.19.3 Reverse rotation prevention selection (Pr. 78)

This function can prevent reverse rotation fault resulting from the incorrect input of the start signal.

Parameter Number	Name	Initial Value	Setting Range	Description
78	Reverse rotation prevention selection	0	0	Both forward and reverse rotations allowed
			1	Reverse rotation disabled
			2	Forward rotation disabled

The above parameters can be set when Pr. 160 User group read selection = "0". (Refer to page 197)

- Set this parameter when you want to limit the motor rotation to only one direction.
- This parameter accepts the command from  on the operation panel or the forward and reverse rotation commands transmitted through communication.

5.19.4 Extended parameter display and user group function (Pr. 160, Pr. 172 to Pr. 174)

Parameters that can be read from the operation panel can be restricted.



POINT

Any parameter can be read via CC-Link communication regardless of the Pr. 160 setting.

Parameter Number	Name	Initial Value	Setting Range	Description
160 *3	User group read selection	0	9999	Displays only the simple mode parameters
			0	Displays simple mode + extended parameters
			1	Displays the parameters registered in the user group.
172 *1	User group registered display/batch clear	0	(0 to 16)	Displays the number of cases registered as a user group (reading only)
			9999	Batch clear the user group registration
173 *1, *2	User group registration	9999	0 to 999, 9999	Sets the parameter numbers to be registered to the user group
174 *1, *2	User group clear	9999	0 to 999, 9999	Sets the parameter numbers to be cleared from the user group

*1 The above parameters can be set when Pr. 160 User group read selection = "0".

*2 The values read from Pr. 173 and Pr. 174 are always "9999".

*3 This parameter allows its setting to be changed during operation in any operation mode even if "0 (initial value) or 1" is set in Pr. 77 Parameter write selection.

(1) Display of simple mode parameters and extended parameters (Pr. 160)

- When Pr. 160 = "9999", only the simple mode parameters can be displayed on the operation panel. (Refer to the parameter list, page 84, for the simple mode parameters.)
- In the initial setting (Pr. 160 = "0") status, simple mode parameters and extended parameters can be displayed.

(2) User group function (Pr. 160, Pr. 172 to Pr. 174)

- The user group function is designed to display only the parameters necessary for setting.
- From among all parameters, 16 parameters maximum can be registered in the user group. When Pr. 160 is set to "1", only the parameters registered to the user group can be accessed. (The parameters not registered in the user group can not be read.)
- To set a parameter in the user group, set its parameter number in Pr. 173.
- To delete a parameter from the user group, set its parameter number to Pr. 174. Set "9999" in Pr. 172 to batch delete parameters registered.

(3) Registration of parameter to user group (Pr. 173)

When registering Pr. 3 to user group

Operation

1. Confirm the operation display and operation mode display.
 - The inverter should be at a stop.
 - Make sure that the inverter is in PU operation mode.
2. Press **(MODE)** to choose the parameter setting mode.
3. Turn **(Rocker)** to change the set value to "P. 173".
4. Press **(SET)** to display 9999.
5. Turn **(Rocker)** until Pr. 3 appears.
6. Press **(SET)** to set.
 "P. 173" and "3" are displayed alternately.
 To continue parameter registration, repeat steps 3 to 6.

Display



(MODE) → P. 0 Parameter setting mode

(Rocker) → P. 173 Displays Pr. 173 User group registration

(SET) → 9999 When Pr. 173 is read, "9999" is displayed

(Rocker) → 3 Select the parameter number to be registered.

(SET) → 3 P. 173

Flicker...Registration of Pr. 3 to user group completed!!

(4) Deletion of parameter from user group (Pr. 174)

When deleting Pr. 3 from user group

Operation

1. Confirm the operation display and operation mode display.
 - The inverter should be at a stop.
 - The inverter should be in the PU operation mode.
2. Press **(MODE)** to choose the parameter setting mode.
3. Turn **(Rocker)** until P. 174 appears.
4. Press **(SET)** to display "9999"
5. Turn **(Rocker)** until Pr. 3 appears.
6. Press **(SET)** to set.
 "P. 174" and "3" are displayed alternately.
 To continue parameter clear, repeat steps 3 to 6.

Display



(MODE) → P. 0 Parameter setting mode

(Rocker) → P. 174 Displays Pr. 174 User group clear

(SET) → 9999 When Pr. 174 is read, "9999" is displayed

(Rocker) → 3 Select the parameter number to be registered.

(SET) → 3 P. 174

Flicker...Clear of Pr. 3 to user group completed!!

REMARKS

- Pr. 77 and Pr. 160 can always be read, independently of the user group setting.
- Pr. 77, Pr. 160 and Pr. 172 to Pr. 174 cannot be registered to the user group.
- When Pr. 174 is read, "9999" is always displayed. Although "9999" can be written, no function is available.
- When any value other than "9999" is set to Pr. 172, no function is available.

5.19.5 Password function (Pr. 296, Pr. 297)

Registering a 4-digit password can restrict parameter reading/writing.

Parameter Number	Name	Initial Value	Setting Range	Description
296 *1	Password lock level	9999	0 to 6, 99, 100 to 106, 199 *4	Select restriction level of parameter reading/writing when a password is registered.
			9999	No password lock
297 *2	Password lock/unlock	9999	1000 to 9998	Register a 4-digit password
			(0 to 5) *3	Displays password unlock error count. (Reading only) (Valid when Pr. 296 = "100" to "106")
			9999 *3	No password lock

The above parameters allow their settings to be changed during operation in any operation mode even if "0 (initial value) or "1" is set in Pr. 77 Parameter write selection.

*1 This parameter can be set when Pr. 160 User group read selection = "0."

*2 If Pr. 296 = "9999" (no password lock), Pr. 297 can be set while Pr. 160 = "0." When the password lock is valid, Pr. 297 can be set regardless of the Pr. 160 setting.

*3 Pr. 297 can be written as "0 or 9999," but the Pr. 297 setting does not change.

*4 Do not set Pr.296 to "0" or "100." Doing so will activate the option fault (E.OPT) and trip the inverter.

(1) Parameter reading/writing restriction level (Pr. 296)

•Level of reading/writing restriction by PU/NET mode operation command can be selected by Pr. 296.

Pr. 296 Setting	Command from the Operation Panel		Command through CC-Link Communication	
	Read *1	Write *2	Read	Write *2
9999	○	○	○	○
0, 100	Option fault (E.OPT) occurs, and the inverter trips.			
1, 101	○	×	○	×
2, 102	○	×	○	○
3, 103	○	○	○	×
4, 104	×	×	○	×
5, 105	×	×	○	○
6, 106	○	○	○	×
99, 199	Only parameters registered in the user group can be read/written. *3 (For the parameters not registered in the user group, same restriction level as "4, 104" applies.)			

○: enabled, ×: restricted

*1 If the parameter reading is restricted by the Pr. 160 setting, those parameters are unavailable for reading even when "○" is indicated.

*2 If the parameter writing is restricted by the Pr. 77 setting, those parameters are unavailable for writing even when "○" is indicated.

*3 Read/write is enabled only in the simple mode parameters registered in the user group when Pr. 160 User group read selection = "9999". Pr. 296 and Pr. 297 are always read/write enabled whether registered to a user group or not.

(2) Password lock/unlock (Pr. 296, Pr. 297)

<Lock>

• Set parameter reading/writing restriction level. (Pr. 296 ≠ 9999)

Pr. 296 Setting Value	Restriction of Password Unlock Error	Pr. 297 Display
0 to 6, 99	No restriction	Always 0
100 to 106, 199	Restricted at fifth error	Displays error count (0 to 5)

* During [Pr. 296 = any of "100 to 106, 199"], if password unlock error has occurred 5 times, correct password will not unlock the restriction. All parameter clear can unlock the restriction.

(In this case, parameter settings are cleared.)

• Write a four-digit number (1000 to 9998) in Pr. 297 as a password.

(When Pr. 296 = "9999", Pr. 297 cannot be written.)

When password is registered, parameter reading/writing is restricted with the restriction level set in Pr. 296 until unlocking.

REMARKS

- After registering a password, a read value of Pr. 297 is always one of "0" to "5".
- When a password restricted parameter is read/written, **LOCd** is displayed.
- Even if a password is registered, parameters which the inverter itself writes, such as inverter parts life, are overwritten as needed.

<Unlock>

There are two ways of unlocking the password.

- Enter a password in Pr. 297.

Unlocked when a password is correct. If a password is incorrect, an error occurs and not unlocked.

During [Pr. 296 = any of "100 to 106, 199"], if password unlock error has occurred 5 times, correct password will not unlock the restriction. (During password lock)

- Perform all parameter clear.



NOTE

- If the password has been forgotten, perform all parameter clear to unlock the parameter restriction. In that case, other parameters are also cleared.
- Parameter all clear can not be performed during the operation.
- Do not use the FR Configurator when parameter read is restricted (Pr. 296 = any of "0, 4, 5, 99, 100, 104, 105, 199"). FR Configurator may not function properly.

REMARKS

- The password unlock method is different for operation panel and CC-Link communication.

	Operation panel	CC-Link communication
All parameter clear (communication instruction code H9966, H55AA)	○	○
Parameter clear (communication instruction code H9696, H5A5A)	×	○

○:Password can be unlocked. ×:Password cannot be unlocked.

(3) Parameter operation during password lock/unlock

Parameter operation		Unlocked		Password registered	Locked
		Pr. 296 = 9999 Pr. 297 = 9999	Pr. 296 ≠ 9999 Pr. 297 = 9999	Pr. 296 ≠ 9999 Pr. 297 = 0 to 4 (Read value)	Pr. 296 = 100 to 106, 199 Pr. 297 = 5 (Read value)
Pr. 296	Read	○ *1	○	○	○
	Write	○ *1	○ *1	×	×
Pr. 297	Read	○ *1	○	○	○
	Write	×	○	○	○ *3
Performing parameter clear		○	○	× *4	× *4
Performing parameter all clear		○	○	○ *2	○ *2

○: enabled, ×: restricted

*1 Reading/writing is unavailable when there is restriction to reading by the Pr. 160 setting. (Reading is available in NET mode regardless of Pr. 160 setting.)

*2 Unavailable during the operation.

*3 Correct password will not unlock the restriction.

*4 Parameter clear is available only from the CC-Link communication option.



Parameters referred to

Pr. 77 Parameter write selection Refer to page 196

Pr. 160 Extended function display selection Refer to page 197

5.20 Special operation and frequency control

Purpose	Parameter that should be Set		Refer to Page
Perform jog operation	Jog operation	Pr. 15, Pr. 16	201
Perform process control such as pump and air volume.	PID control	Pr. 127 to Pr. 132, Pr. 134, Pr. 125, C2	203
Frequency control appropriate for load torque	Droop control	Pr. 286, Pr. 287	210
Avoid overvoltage alarm due to regeneration by automatic adjustment of output frequency	Regeneration avoidance function	Pr. 882, Pr. 883, Pr. 885, Pr. 886	211

5.20.1 JOG operation (Pr. 15, Pr. 16)

You can set the frequency and acceleration/deceleration time for JOG operation. JOG operation can be performed from the operation panel.

This operation can be used for conveyor positioning, test operation, etc.

Parameter Number	Name	Initial Value	Setting Range	Description
15	Jog frequency	5Hz	0 to 400Hz	Frequency for Jog operation.
16	Jog acceleration/ deceleration time	0.5s	0 to 3600/ 360s *	Acceleration/deceleration time for Jog operation. As the acceleration/ deceleration time, set the time taken to reach the frequency (initial value is 60Hz) set in Pr. 20 Acceleration/deceleration reference frequency. Acceleration/deceleration time can not be set separately.

The above parameters can be set when Pr. 160 User group read selection = "0". (Refer to page 197)

* When the Pr. 21 Acceleration/deceleration time increments setting is "0" (initial value), the setting range is "0 to 3600s" and setting increments is "0.1s". When the setting is "1", the setting range is "0 to 360s" and the setting increments is "0.01s".

(1) Jog operation from operation panel

•Selects Jog operation mode from the operation panel. Operation is performed only while the start button is pressed.

Operation

- Confirmation of the operating status indicator and operation mode indicator
 - The monitor mode should have been selected.
 - The inverter should be at a stop.
- Press **PU EXT** to choose the PU Jog operation mode.
- Press **RUN**.
 - While **RUN** is pressed, the motor rotates.
 - The motor runs at 5Hz. (*Pr. 15* initial value)
- Release **RUN**



Display



[When changing the frequency of PU Jog operation]

- Press **MODE** to choose the parameter setting mode.
- Turn **▲** until *Pr. 15 Jog frequency* appears.
- Press **SET** to show the currently set value. (5Hz)
- Turn **▲** to set the value to "1000". (10Hz)
- Press **SET** to set.



PRM indicator is lit.



⇒ (The parameter number read previously appears.)



Flicker...Parameter setting complete!!

- Perform the operations in steps 1 to 4.
The motor rotates at 10Hz.



NOTE

- When *Pr. 29 Acceleration/deceleration pattern selection* = "1" (S-pattern acceleration/deceleration A), the acceleration/deceleration time is the period of time required to reach *Pr. 3 Base frequency*.
- The *Pr. 15 setting* should be equal to or higher than the *Pr. 13 Starting frequency*.
- During Jog operation, the second acceleration/deceleration via the RT signal cannot be selected. (The other second functions are valid. (Refer to page 165))



Parameters referred to

- Pr. 13 Starting frequency* Refer to page 138
- Pr. 20 Acceleration/deceleration reference frequency, Pr. 21 Acceleration/deceleration time increments* Refer to page 135
- Pr. 29 Acceleration/deceleration pattern selection* Refer to page 139

5.20.2 PID control (Pr. 125, Pr. 127 to Pr. 132, Pr. 134, C2)

The inverter can be used to exercise process control, e.g. flow rate, air volume or pressure. Use the value set in the CC-Link communication register (RWw9) as the set point, and the value set in the CC-Link communication register (RWwA) as the feedback value. With these values, configure a feedback system and perform PID control.

Parameter Number	Name	Initial Value	Setting Range	Description	
127	PID control automatic switchover frequency	9999	0 to 400Hz	Frequency at which the control is automatically changed to PID control.	
			9999	Without PID automatic switchover function	
128	PID action selection	0	0	PID action is not performed	
			20, 21, 40 to 43	For manufacturer setting. Do not set.	
			50	PID reverse action	Deviation value signal input (CC-Link communication)
			51	PID forward action	
			60	PID reverse action	Measured value, set point input (CC-Link communication)
			61	PID forward action	
129 *1	PID proportional band	100%	0.1 to 1000%	If the proportional band is narrow (parameter setting is small), the manipulated variable varies greatly with a slight change of the measured value. Hence, as the proportional band narrows, the response sensitivity (gain) improves but the stability deteriorates, e.g. hunting occurs. Gain $K_p = 1/\text{proportional band}$	
			9999	No proportional control	
130 *1	PID integral time	1s	0.1 to 3600s	When deviation step is input, time (Ti) is the time required for integral (I) action to provide the same manipulated variable as the proportional (P) action. As the integral time decreases, the set point is reached earlier but hunting occurs more easily.	
			9999	No integral control.	
131	PID upper limit	9999	0 to 100%	Maximum value If the feedback value exceeds the setting, the FUP signal is output. The maximum input of the measured value is equivalent to 100%.	
			9999	No function	
132	PID lower limit	9999	0 to 100%	Minimum frequency If the process value falls below the setting range, the FDN signal is output. The maximum input of the measured value is equivalent to 100%.	
			9999	No function	
134 *1	PID differential time	9999	0.01 to 10.00s	For deviation ramp input, time (Td) required for providing only the manipulated variable for the proportional (P) action. As the differential time increases, greater response is made to a deviation change.	
			9999	No differential control.	
125	Frequency setting gain	60Hz	0 to 400Hz	Output frequency at 100% deviation input under PID control	
C2	Frequency setting bias	0Hz	0 to 400Hz	Output frequency at 0% deviation input under PID control	

The above parameters can be set when Pr. 160 User group read selection = "0". (Refer to page 197)

*1 This parameter allows its setting to be changed during operation in any operation mode even if "0" (initial value) is set in Pr. 77 Parameter write selection.

(1) PID control basic configuration

•Pr. 128 = "50, 51" (measured value input)

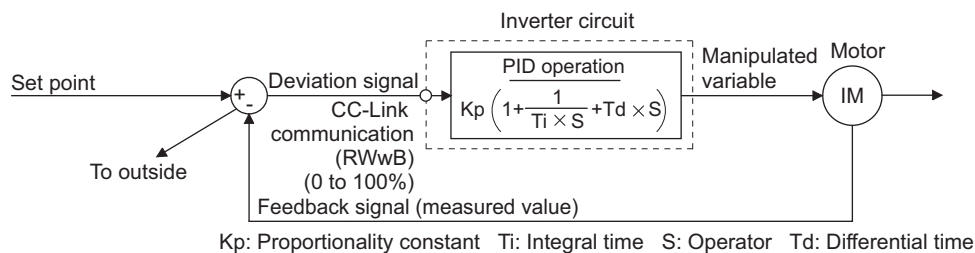

•Pr: 128 = "60, 61" (measured value input)

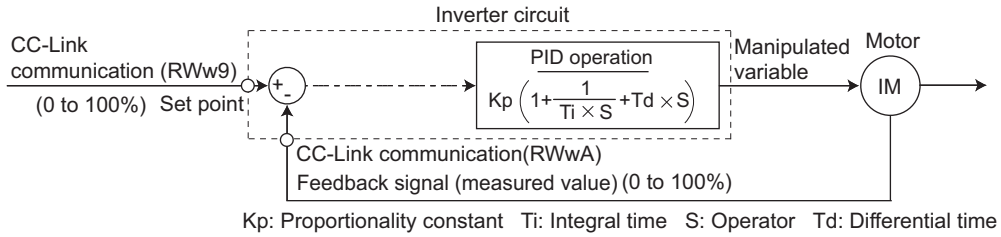

(2) PID action overview

1)PI action

A combination of proportional control action (P) and integral control action (I) for providing a manipulated variable in response to deviation and changes with time.

[Operation example for stepped changes of process value]

(Note) PI action is the sum of P and I actions.

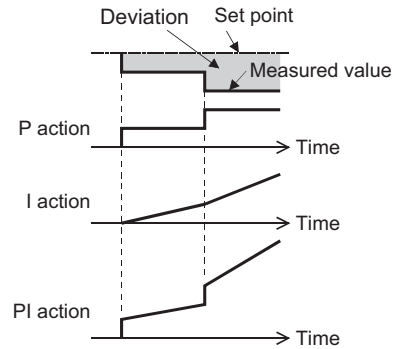

2)PD action

A combination of proportional control action (P) and differential control action (D) for providing a manipulated variable in response to deviation speed to improve the transient characteristic.

[Operation example for proportional changes of process value]

(Note) PD action is the sum of P and D actions.

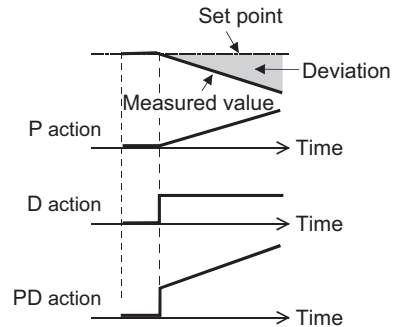

3)PID action

The PI action and PD action are combined to utilize the advantages of both actions for control.

(Note) PID action is the sum of P, I and D actions.

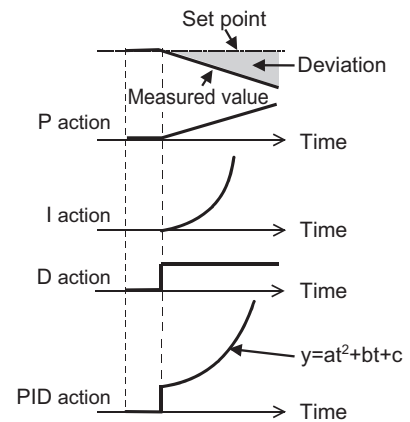

4) Reverse operation

Increases the manipulated variable (output frequency) if deviation $X = (\text{set point} - \text{measured value})$ is positive, and decreases the manipulated variable if deviation is negative.

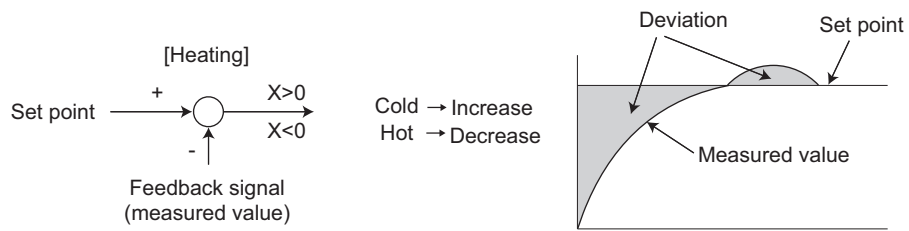

5) Forward operation

Increases the manipulated variable (output frequency) if deviation $X = (\text{set point} - \text{measured value})$ is negative, and decreases the manipulated variable if deviation is positive.

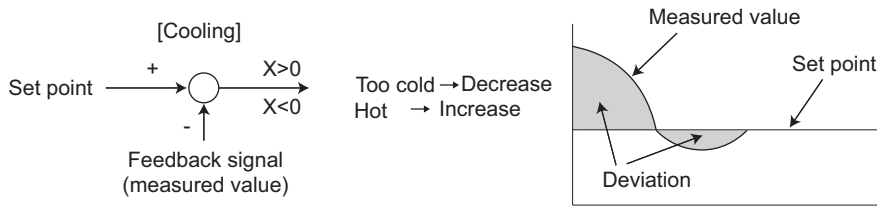

Relationships between deviation and manipulated variable (output frequency)

	Deviation	
	Positive	Negative
Reverse action	↗	↘
Forward action	↘	↗

(3) Connection diagram

•Pr. 128 = 60

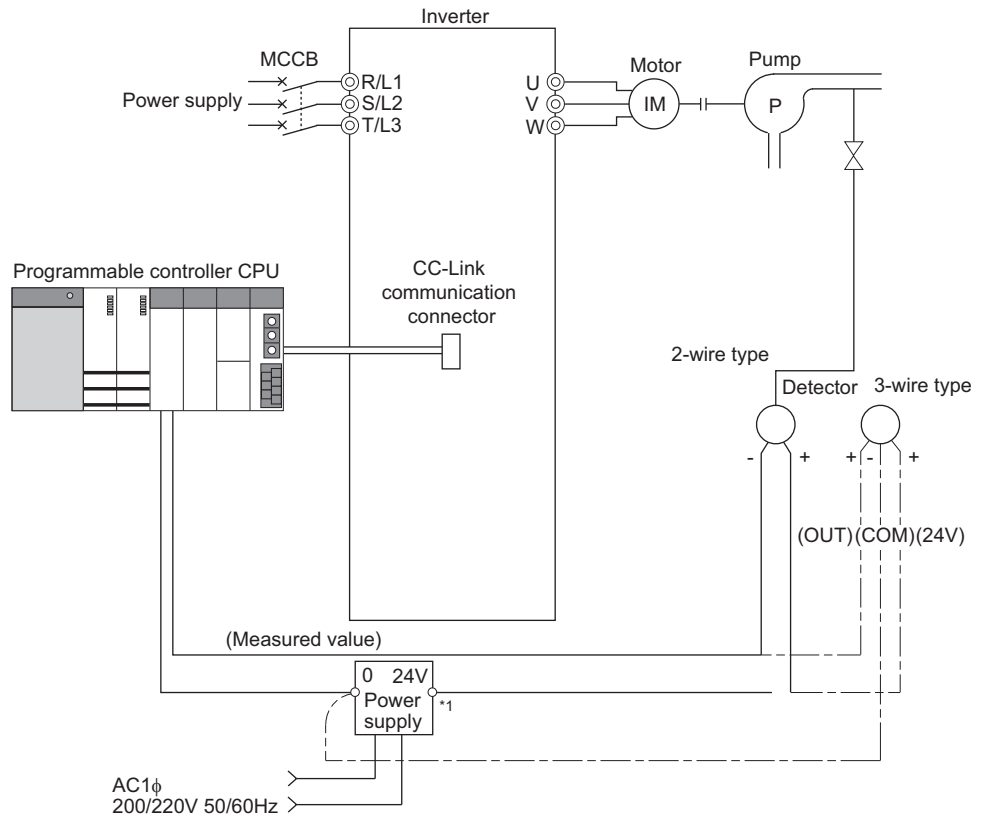

*1 The power supply must be selected in accordance with the power specifications of the detector used.

(4) I/O signals and parameter setting

- Set "50, 51, 60 or 61" in *Pr. 128* to perform PID operation.
- Set "14" in any of *Pr. 180 to Pr. 184* (input terminal function selection) to assign the PID control selection signal (X14) to turn the X14 signal ON.

When the X14 signal is not assigned, only the *Pr. 128* setting makes PID control valid.

- Enter the set point and measured value via CC-Link communication.



REMARKS

- When *Pr. 128* = "0" or X14 signal is OFF, normal inverter operation is performed without PID action.
- Turning ON/OFF of bit of the virtual terminal, to which X14 signal is assigned through CC-Link communication, enables PID control.

	Signal	Terminal Used	Function	Description	Parameter Setting
Input	X14	Depending on <i>Pr. 180 to Pr. 184</i>	PID control selection	Turn ON X14 signal to perform PID control. *1	Set 14 in any of <i>Pr. 180 to Pr. 184</i> .
	CC-Link Communication	—	Deviation value input	Inputs the deviation value from CC-Link communication.	<i>Pr. 128</i> = 50, 51
Output	FUP	Depending on <i>Pr. 190 to Pr. 192, Pr. 313 to Pr. 315</i>	Upper limit output	Output to indicate that the measured value signal exceeded the maximum value (<i>Pr. 131</i>).	<i>Pr. 128</i> = 60, 61 <i>Pr. 131</i> ≠ 9999 Set 15 or 115 in any of <i>Pr. 190 to Pr. 192, Pr. 313 to Pr. 315</i> . *2
	FDN		Lower limit output	Output when the measured value signal falls below the minimum value (<i>Pr. 132</i>).	<i>Pr. 128</i> = 60, 61 <i>Pr. 132</i> ≠ 9999 Set 14 or 114 in any of <i>Pr. 190 to Pr. 192, Pr. 313 to Pr. 315</i> . *2
	RL		Forward (reverse) rotation direction output	"Hi" is output to indicate that the output indication of the operation panel is forward rotation or "Low" to indicate that it is reverse rotation or stop.	Set 16 or 116 in any of <i>Pr. 190 to Pr. 192, Pr. 313 to Pr. 315</i> . *2
	PID		During PID control activated	Turns ON during PID control.	Set 47 or 147 in any of <i>Pr. 190 to Pr. 192, Pr. 313 to Pr. 315</i> . *2

*1 When the X14 signal is not assigned, only the *Pr. 128* setting makes PID control valid.

*2 When 100 or larger value is set in any of *Pr. 190 to Pr. 192, Pr. 313 to Pr. 315* (output terminal function selection), the terminal output has negative logic. (For details, Refer to page 167)



NOTE

- Changing the assignment of the terminal Y0 or a virtual terminal of CC-Link communication with one of *Pr. 180 to Pr. 184, Pr. 190 to Pr. 192, and Pr. 313 to Pr. 315* may affect other functions.
Set parameters after confirming the function of the terminal Y0 and virtual terminals.

(5) PID automatic switchover control (Pr. 127)

- The system can be started up without PID control only at a start.
- When the frequency is set to *Pr. 127 PID control automatic switchover frequency* within the range 0 to 400Hz, the inverter starts up without PID control from a start until output frequency is reached to the set frequency of *Pr. 127*, and then it shifts to PID control. Once the system has entered PID control operation, it continues PID control if the output frequency falls to or below *Pr.127*.

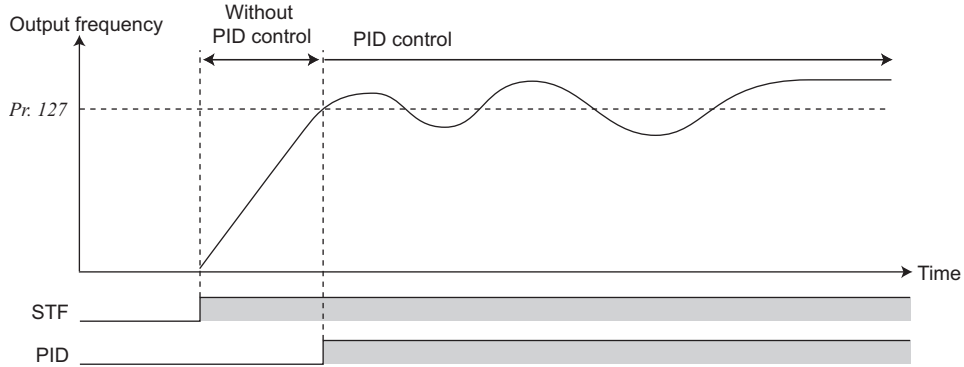

(6) PID monitor function

- The PID control set point, measured value and deviation value can be displayed on the operation panel.
- Integral value indicating a negative % can be displayed on the deviation monitor. 0% is displayed as 1000.
- For each monitor, set the following value in *Pr. 52 DU/PU main display data selection*.

Setting	Monitor Description	Minimum Increments	Remarks
52	PID set point	0.1%	—
53	PID measured value	0.1%	
54	PID deviation	0.1%	

(7) Adjustment procedure

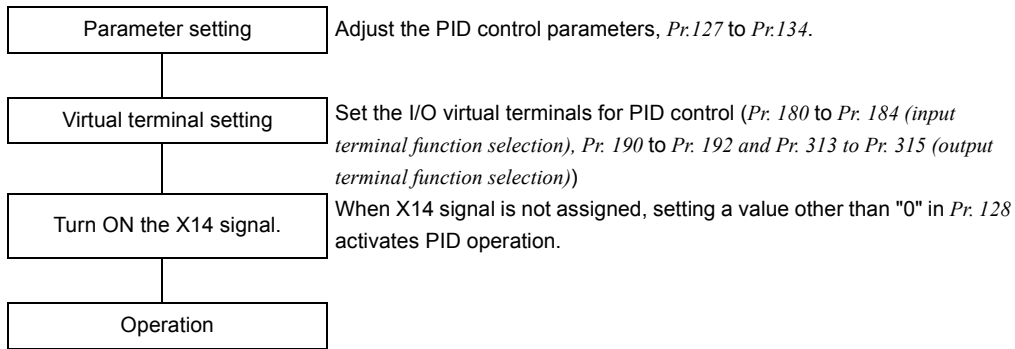

(8) Calibration example

Set the room temperature to be 25°C with PID control, which has its set point commanded though the master module to the inverter.

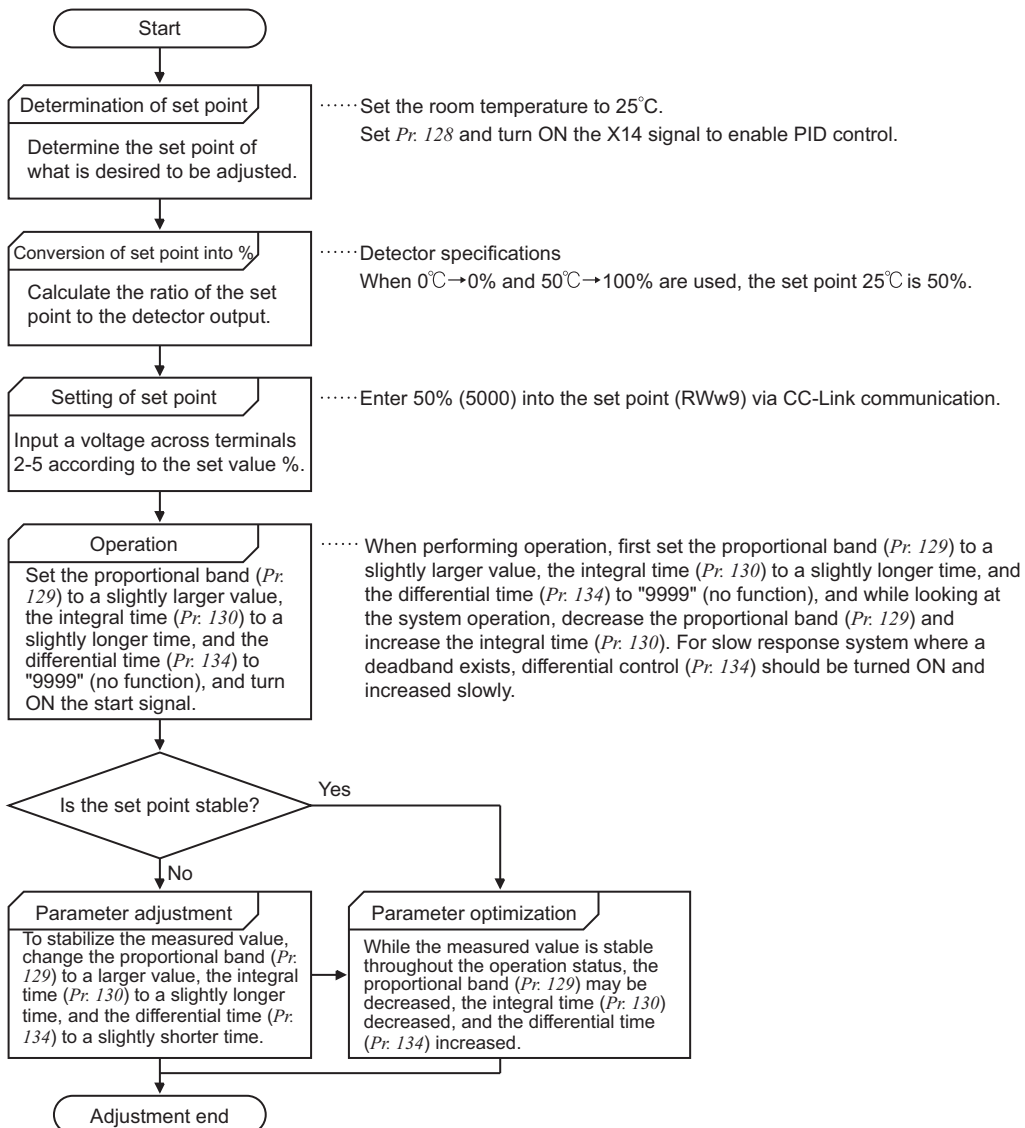

(9) Changing the frequency at a deviation input (Pr.125, C2)

- To change the output frequency at 0% deviation, set the new frequency in *C2 Frequency setting bias* (initially 0Hz).
- To change the output frequency at 100% deviation, set the new frequency in *Pr. 125 Frequency setting gain* (initially 60Hz).

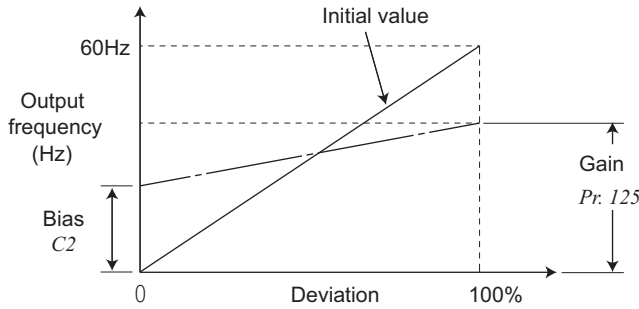

NOTE

- If the RH, RM, RL signal (multi-speed) or JOG operation is entered with the X14 signal ON, PID control is stopped and multi-speed or Jog operation started.
- With the following setting, PID control is invalid.
Pr. 79 Operation mode selection = "6" (switchover mode)
 When the inverter is at a stop with *Pr. 261 Power failure stop selection* selected.
- Changing the assignment of the terminal Y0 or a virtual terminal of CC-Link communication with one of *Pr. 180 to Pr. 184, Pr. 190 to Pr. 192, and Pr. 313 to Pr. 315* may affect other functions. Set parameters after confirming the function of the terminal Y0 and virtual terminals.
- The remote operation function is invalid during PID operation.
- When the control is switched to PID control during normal operation, the frequency command value calculated by PID operation using 0Hz as standard is used without the frequency during the operation.

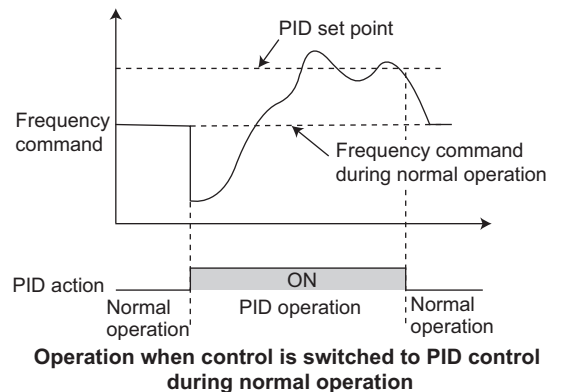

Parameters referred to

- Pr. 59 Remote function selection* Refer to page 132
- Pr. 79 Operation mode selection* Refer to page 103
- Pr. 180 to Pr. 184 (input terminal function selection)* Refer to page 163
- Pr. 190 to Pr. 192, Pr. 313 to Pr. 315 (output terminal function selection)* Refer to page 167
- Pr. 261 Power failure stop selection* Refer to page 186

5.20.3 Droop control (Pr. 286, Pr. 287)

This function is designed to balance the load in proportion to the load torque to provide the speed drooping characteristic under Advanced magnetic flux vector control.

This function is effective for balancing the load when using multiple inverters.

Parameter Number	Name	Initial Value	Setting Range	Description
286	Droop gain	0%	0	Droop control is invalid (Normal operation)
			0.1% to 100%	Droop control is valid Drooping amount at the rated torque as a percentage with respect to the rated motor frequency.
287	Droop filter time constant	0.3s	0 to 1s	Time constant of the filter applied on the torque current.

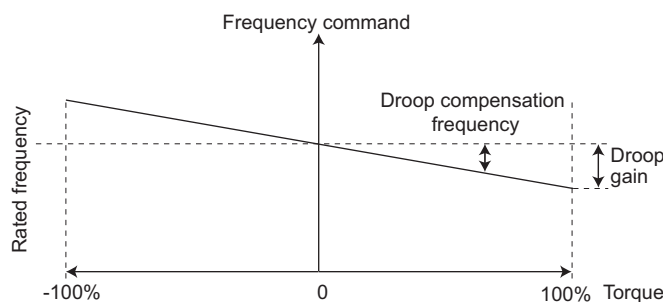

(1) Droop control

- The output frequency is changed according to the magnitude of torque current under Advanced magnetic flux vector control. The drooping amount at the rated torque is set by the droop gain as a percentage using the rated frequency as a reference.
- The maximum droop compensation frequency is 120Hz.

$$\text{Droop compensation frequency} = \frac{\text{Torque current after filtering}}{\text{Rated value of torque current}} \times \frac{\text{Pr. 84 Rated motor frequency} \times \text{Pr. 286 Droop gain}}{100}$$

REMARKS

- Set the droop gain to about the rated slip of the motor.

$$\text{Rated slip} = \frac{\text{Synchronous speed at base frequency} - \text{rated speed}}{\text{Synchronous speed at base frequency}} \times 100[\%]$$

- Droop control is invalid during PID control operation.
- The maximum value of frequency after droop compensation is either 120Hz or *Pr. 1 Maximum frequency*, whichever is smaller.

Parameters referred to

Pr. 1 Maximum frequency  Refer to page 124

PID control  Refer to page 203

5.20.4 Regeneration avoidance function (Pr. 665, Pr. 882, Pr. 883, Pr. 885, Pr. 886)

This function detects a regeneration status and increases the frequency to avoid the regenerative status.

- Possible to avoid regeneration by automatically increasing the frequency and continue operation if the fan happens to rotate faster than the set speed due to the effect of another fan in the same duct.

Parameter Number	Name	Initial Value	Setting Range	Description
882	Regeneration avoidance operation selection	0	0	Regeneration avoidance function invalid
			1	Regeneration avoidance function is always valid
			2	Regeneration avoidance function is valid only during a constant speed operation
883	Regeneration avoidance operation level	200V class 400 VDC	300 to 800V	Bus voltage level at which regeneration avoidance operates. When the bus voltage level is set to low, overvoltage error will be less apt to occur. However, the actual deceleration time increases. The set value must be higher than the "power supply voltage $\times \sqrt{2}$ ".
		400V class 780 VDC		
885	Regeneration avoidance compensation frequency limit value	6Hz	0 to 10Hz	Limit value of frequency which rises at activation of regeneration avoidance function.
			9999	Frequency limit invalid
886	Regeneration avoidance voltage gain	100%	0 to 200%	Responsiveness at activation of regeneration avoidance. A larger setting will improve responsiveness to the bus voltage change. However, the output frequency could become unstable.
665	Regeneration avoidance frequency gain	100%	0 to 200%	When vibration is not suppressed by decreasing the Pr. 886 setting, set a smaller value in Pr. 665.

The above parameters can be set when Pr. 160 User group read selection = "0". (Refer to page 197)

(1) What is regeneration avoidance function? (Pr. 882, Pr. 883)

- When the regeneration load is large, the DC bus voltage rises and an overvoltage fault (E. OV□) may occur. When this bus voltage rise is detected and the bus voltage level reaches or exceeds Pr. 883, increasing the frequency avoids the regeneration status.
- The regeneration avoidance function is always ON when "1" is set in Pr. 882 and activated only during a constant speed when "2" is set in Pr. 882.

Regeneration avoidance operation example for acceleration

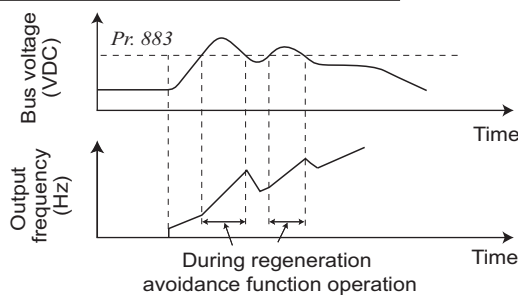

Regeneration avoidance operation example for constant speed

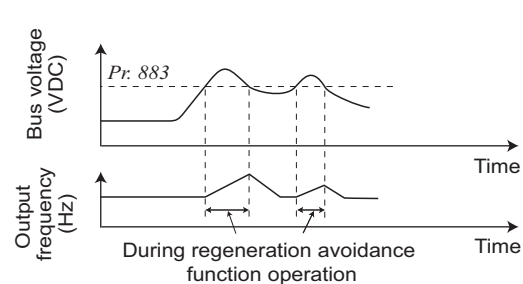

Regeneration avoidance operation example for deceleration

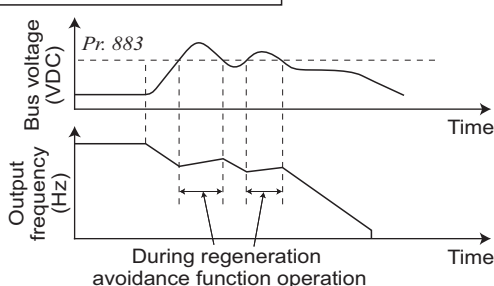



REMARKS

- The acceleration/deceleration ramp while the regeneration avoidance function is operating changes depending on the regeneration load.
- The DC bus voltage of the inverter is about $\sqrt{2}$ times as input voltage.
When the input voltage is 220VAC, bus voltage is approximately 311VDC.
When the input voltage is 440VAC, bus voltage is approximately 622VDC.
However, it varies with the input power supply waveform.
- The *Pr. 883* setting should be kept higher than the DC bus voltage level. Otherwise, the regeneration avoidance function is always on even in the non-regeneration status and the frequency increases.
- While overvoltage stall (OL) is activated only during deceleration and stops the output frequency, the regeneration avoidance function is always on (*Pr. 882* = 1) or activated only during a constant speed (*Pr. 882* = 2) and increases the frequency according to the regeneration amount.

(2) Limit regeneration avoidance operation frequency (*Pr. 885*)

You can limit the output frequency compensated for (increased) by the regeneration avoidance function.

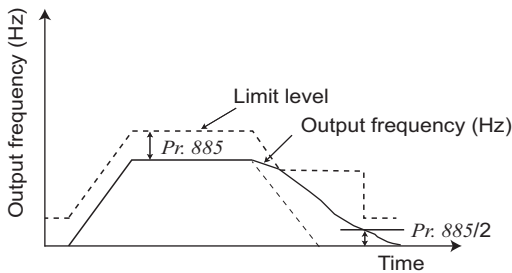

- The frequency is limited to the output frequency (frequency prior to regeneration avoidance operation) + *Pr. 885* Regeneration avoidance compensation frequency limit value during acceleration or constant speed. If the frequency increased by regeneration avoidance function exceeds the limit value during deceleration, the limit value is held until the output frequency falls to 1/2 of *Pr. 885*.
- When the frequency increased by regeneration avoidance function has reached *Pr. 1* Maximum frequency, it is limited to the maximum frequency.
- When *Pr. 885* is set to "9999", regeneration avoidance function operation frequency setting is invalid.

(3) Regeneration avoidance function adjustment (*Pr. 665, Pr. 886*)

- If the frequency becomes unstable during regeneration avoidance operation, decrease the setting of *Pr. 886* Regeneration avoidance voltage gain. Reversely, if sudden regeneration causes an overvoltage alarm, increase the setting.
When vibration is not suppressed by decreasing the *Pr. 886* setting, set a smaller value in *Pr. 665* Regeneration avoidance frequency gain.



NOTE

- When regeneration avoidance operation is performed, OL (overvoltage stall) is displayed and the OL signal is output. Set the operation pattern at an OL signal output using *Pr.156* Stall prevention operation selection. Set the output timing of the OL signal using *Pr. 157* OL signal output timer.
- When regeneration avoidance operation is performed, stall prevention is also activated.
- The regeneration avoidance function cannot shorten the actual deceleration time taken to stop the motor. The actual deceleration time depends on the regeneration energy consumption capability. When shortening the deceleration time, consider using the regeneration unit (FR-BU2) and brake resistor (MRS type, MYS type and FR-ABR etc.) to consume regeneration energy at constant speed.
- When using the regeneration unit (FR-BU2) and brake resistor (MRS type, MYS type, FR-ABR etc.), set *Pr. 882* to "0 (initial value)" (regeneration avoidance function invalid). When using the regeneration unit, etc. to consume regeneration energy at deceleration, set *Pr. 882* to "2" (regeneration avoidance function valid only at a constant speed).



Parameters referred to

Pr. 1 Maximum frequency Refer to page 124

Pr. 8 Deceleration time Refer to page 135

Pr. 22 Stall prevention operation level Refer to page 120

5.21 Useful functions

Purpose	Parameter that should be Set		Refer to Page
Increase cooling fan life	Cooling fan operation selection	Pr. 244	213
To determine the maintenance time of parts.	Inverter part life display	Pr. 255 to Pr. 259	214
	Maintenance output function	Pr. 503, Pr. 504	217
	Current average value monitor signal	Pr. 555 to Pr. 557	218
Communication using USB (FR Configurator)	USB communication	Pr. 547, Pr. 548, Pr. 551	220
Freely available parameter	Free parameter	Pr. 888, Pr. 889	222

5.21.1 Cooling fan operation selection (Pr. 244)

You can control the operation of the cooling fan built in the inverter (FR-E720-1.5KNC or higher, FR-E740-1.5KNC or higher, FR-E720S-0.75KNC or higher).

Parameter Number	Name	Initial Value	Setting Range	Description
244	Cooling fan operation selection	1	0	Operates in power-ON status. Cooling fan ON/OFF control invalid (the cooling fan is always ON at power ON)
			1	Cooling fan ON/OFF control valid The fan is always ON while the inverter is running. During a stop, the inverter status is monitored and the fan switches ON-OFF according to the temperature.

The above parameters can be set when Pr.160 User group read selection = "0". (Refer to page 197)

- In either of the following cases, fan operation is regarded as faulty, [FN] is shown on the operation panel, and the fan fault (FAN) and alarm (LF) signals are output.
 - Pr. 244 = "0"
When the fan comes to a stop with power ON.
 - Pr. 244 = "1"
When the inverter is running and the fan stops during fan ON command.
- To assign the FAN signal to the terminal Y0 or a virtual terminal of CC-Link communication, set "25 (positive logic) or 125 (negative logic)" in one of Pr. 190 to Pr. 192 and Pr. 313 to Pr. 315 (output terminal function selection). To assign the LF signal, set "98 (positive logic) or 198 (negative logic)."



NOTE

- Changing the assignment of the terminal Y0 or a virtual terminal of CC-Link communication with one of Pr. 190 to Pr. 192, and Pr. 313 to Pr. 315 (output terminal function selection) may affect other functions. Set parameters after confirming the function of the terminal Y0 and virtual terminals.



Parameters referred to

Pr. 190 to Pr. 192, Pr. 313 to Pr. 315 (output terminal function selection)  Refer to page 167

5.21.2 Display of the life of the inverter parts (Pr. 255 to Pr. 259)

Degrees of deterioration of main circuit capacitor, control circuit capacitor, cooling fan and inrush current limit circuit can be diagnosed by monitor.

When any part has approached the end of its life, an alarm can be output by self diagnosis to prevent a fault.

(Use the life check of this function as a guideline since the life except the main circuit capacitor is calculated theoretically.)

For the life check of the main circuit capacitor, the alarm signal (Y90) will not be output if a measuring method of (4) is not performed.

Parameter Number	Name	Initial Value	Setting Range	Description
255	Life alarm status display	0	(0 to 15)	Displays whether the control circuit capacitor, main circuit capacitor, cooling fan, and each parts of the inrush current limit circuit has reached the life alarm output level or not. (Reading only)
256	Inrush current limit circuit life display	100%	(0 to 100%)	Displays the deterioration degree of the inrush current limit circuit. (Reading only)
257	Control circuit capacitor life display	100%	(0 to 100%)	Displays the deterioration degree of the control circuit capacitor. (Reading only)
258	Main circuit capacitor life display	100%	(0 to 100%)	Displays the deterioration degree of the main circuit capacitor. (Reading only) The value measured by Pr. 259 is displayed.
259	Main circuit capacitor life measuring	0	0, 1 (2, 3, 8, 9)	Setting "1" and turning the power supply off starts the measurement of the main circuit capacitor life. When the Pr. 259 value is "3" after powering on again, the measuring is completed. Writes deterioration degree in Pr. 258.

The above parameters can be set when Pr. 160 User group read selection = "0". (Refer to page 197)



REMARKS

- Since repeated inrush currents at power ON will shorten the life of the converter circuit, frequent starts and stops of the magnetic contactor must be avoided.

(1) Life alarm display and signal output (Y90 signal, Pr. 255)

- Whether any of the control circuit capacitor, main circuit capacitor, cooling fan and inrush current limit circuit has reached the life alarm output level or not can be checked by Pr. 255 Life alarm status display and life alarm signal (Y90).

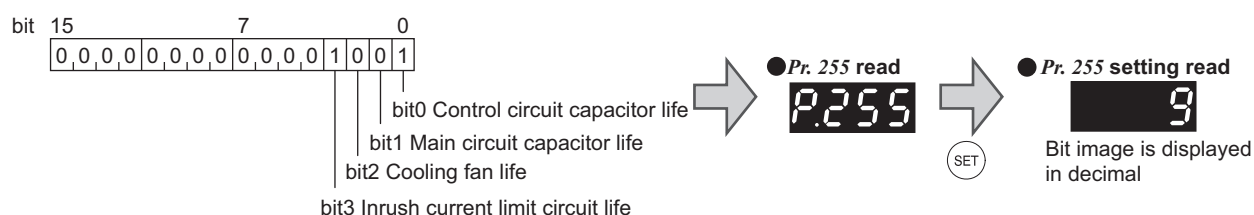

Pr. 255 (decimal)	Bit (binary)	Inrush Current Suppression Circuit Life	Cooling Fan Life	Main Circuit Capacitor Life	Control Circuit Capacitor Life
15	1111	○	○	○	○
14	1110	○	○	○	×
13	1101	○	○	×	○
12	1100	○	○	×	×
11	1011	○	×	○	○
10	1010	○	×	○	×
9	1001	○	×	×	○
8	1000	○	×	×	×
7	0111	×	○	○	○
6	0110	×	○	○	×
5	0101	×	○	×	○
4	0100	×	○	×	×
3	0011	×	×	○	○
2	0010	×	×	○	×
1	0001	×	×	×	○
0	0000	×	×	×	×

○: With warnings, ×: Without warnings

- The life alarm signal (Y90) turns ON when any of the control circuit capacitor, main circuit capacitor, cooling fan and inrush current limit circuit reaches the life alarm output level.
- To assign the Y90 signal to the terminal Y0 or a virtual terminal of CC-Link communication, set "90 (positive logic) or 190 (negative logic)" in one of Pr. 190 to Pr. 192 and Pr. 313 to Pr. 315 (output terminal function selection).

**NOTE**

- Changing the assignment of the terminal Y0 or a virtual terminal of CC-Link communication with one of Pr. 190 to Pr. 192, and Pr. 313 to Pr. 315 (output terminal function selection) may affect other functions. Set parameters after confirming the function of the terminal Y0 and virtual terminals.

(2) Inrush current limit circuit life display (Pr. 256)

- The life of the inrush current limit circuit (relay, contactor and inrush resistor) is displayed in Pr. 256.
- The number of contact (relay, contactor, thyristor) ON times is counted, and it is counted down from 100% (0 times) every 1%/10,000 times. As soon as 10% (900,000 times) is reached, Pr. 255 bit 3 is turned ON and also an alarm is output to the Y90 signal.

(3) Control circuit capacitor life display (Pr. 257)

- The deterioration degree of the control circuit capacitor is displayed in Pr. 257 as a life.
- In the operating status, the control circuit capacitor life is calculated from the energization time and temperature, and is counted down from 100%. As soon as the control circuit capacitor life falls below 10%, Pr. 255 bit 0 is turned ON and also an alarm is output to the Y90 signal.

(4) Main circuit capacitor life display (Pr. 258, Pr. 259)

- The deterioration degree of the control circuit capacitor is displayed in Pr. 258 as a life.
- On the assumption that the main circuit capacitor capacitance at factory shipment is 100%, the capacitor life is displayed in Pr. 258 every time measurement is made.

When the measured value falls to or below 85%, Pr. 255 bit 1 is turned ON and also an alarm is output to the Y90 signal.

- Measure the capacitor capacity according to the following procedure and check the deterioration level of the capacitor capacity.
 - 1) Check that the motor is connected and at a stop.
 - 2) Set "1" (measuring start) in Pr. 259.
 - 3) Switch power OFF. The inverter applies DC voltage to the motor to measure the capacitor capacity while the inverter is OFF.
 - 4) After confirming that the LED of the operation panel is OFF, power ON again. (When using the 24V external power supply, turn ON the power again after "EV" appears.)
 - 5) Check that "3" (measuring completion) is set in Pr. 259, read Pr. 258, and check the deterioration degree of the main circuit capacitor.

Pr. 259	Description	Remarks
0	No measurement	Initial value
1	Measurement start	Measurement starts when the power supply is switched OFF.
2	During measurement	Only displayed and cannot be set
3	Measurement complete	
8	Forced end	
9	Measurement error	



REMARKS

- When the main circuit capacitor life is measured under the following conditions, "forced end" (Pr. 259 = "8") or "measuring error" (Pr. 259 = "9") occurs or it remains in "measuring start" (Pr. 259 = "1"). Therefore, do not measure in such case. In addition, even when "measurement completion" (Pr. 259 = "3") is confirmed under the following conditions, normal measurement can not be done.
 - (a) DC power supply is connected to the terminal P/+ and N/-.
 - (b) The power supply switched ON during measurement.
 - (c) The motor is not connected to the inverter.
 - (d) The motor is running (coasting)
 - (e) The motor capacity is two rank smaller as compared to the inverter capacity.
 - (f) The inverter is tripped or a fault occurred when power is OFF.
 - (g) The inverter output is shut off with the MRS signal.
 - (h) The start command is given while measuring.
 - (i) An input/output signal to/from the control terminal block or a signal of CC-Link communication is ON (conducting).
 - (j) "EV" is displayed on the operation panel. (The main circuit power supply is OFF and the 24V external power supply is ON.)
- Turning the power ON during measuring before LED of the operation panel turns OFF, it may remain in "measuring" (Pr. 259 = "2") status. In such case, carry out operation from step 2.



POINT

- For accurate life measurement of the main circuit capacitor, wait 3 hours or longer after powering OFF. The temperature left in the main circuit capacitor affects measurement.



WARNING

- ⚠ When measuring the main circuit capacitor capacity (Pr. 259 Main circuit capacitor life measuring = "1"), the DC voltage is applied to the motor for 1s at powering OFF. Never touch the motor terminal, etc. right after powering OFF to prevent an electric shock.

(5) Cooling fan life display

- The cooling fan speed of 50% or less is detected and "FN" is displayed on the operation panel. As an alarm display, Pr. 255 bit 2 is turned ON and also an alarm is output to the Y90 signal.

**REMARKS**

- When the inverter is mounted with two or more cooling fans, "FN" is displayed with one or more fans with speed of 50% or less.

**NOTE**

- For replacement of each part, contact the nearest Mitsubishi FA center.

5.21.3 Maintenance timer alarm (Pr. 503, Pr. 504)

When the cumulative energization time of the inverter reaches the parameter set time, the maintenance timer output signal (Y95) is output.  (MT) is displayed on the operation panel.

This can be used as a guideline for the maintenance time of peripheral devices.

Parameter Number	Name	Initial Value	Setting Range	Description
503	Maintenance timer	0	0 (1 to 9998)	Displays the cumulative energization time of the inverter in 100h increments. (Reading only) Writing the setting of "0" clears the cumulative energization time while Pr. 503 = "1 to 9998".
504	Maintenance timer alarm output set time	9999	0 to 9998	Time taken until when the maintenance timer alarm output signal (Y95) is output.
			9999	No function

The above parameters can be set when Pr. 160 User group read selection = "0". (Refer to page 197)

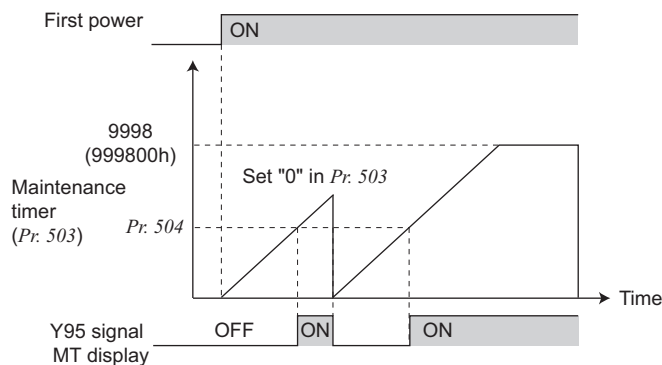

- The cumulative energization time of the inverter is stored into the EEPROM every hour and is displayed in Pr. 503 Maintenance timer in 100h increments. Pr. 503 is clamped at 9998 (999800h).
- When the Pr. 503 value reaches the time set to Pr. 504 Maintenance timer alarm output set time (100h increments), the maintenance timer alarm output signal (Y95) is output.
- To assign the Y95 signal to the terminal Y0 or a virtual terminal of CC-Link communication, set "95 (positive logic) or 195 (negative logic)" in one of Pr.190 to Pr.192 and Pr.313 to Pr.315 (output terminal function selection).

**NOTE**

- The cumulative energization time is counted every hour. The energization time of less than 1h is not counted.
- Changing the assignment of the terminal Y0 or a virtual terminal of CC-Link communication with one of Pr. 190 to Pr. 192, and Pr. 313 to Pr. 315 (output terminal function selection) may affect other functions. Set parameters after confirming the function of the terminal Y0 and virtual terminals.

**Parameters referred to**

Pr. 190 to Pr. 192, Pr.313 to Pr.315 (output terminal function selection)  Refer to page 167

5.21.4 Average current monitor signal (Pr. 555 to Pr. 557)

The average value of the output current during constant speed operation and the maintenance timer value are output as a pulse to the current average value monitor signal (Y93).

The pulse width output to the I/O module of the programmable controller or the like can be used as a guideline due to abrasion of machines and elongation of the belt and for aged deterioration of devices to know the maintenance time.

The current average value monitor signal (Y93) is output as pulse for 20s as 1 cycle and repeatedly output during constant speed operation.

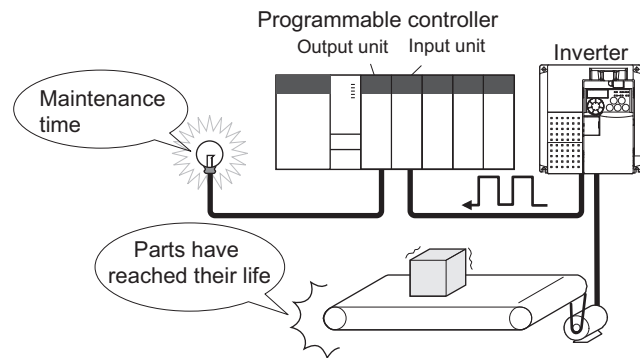

Parameter Number	Name	Initial Value	Setting Range	Description
555	Current average time	1s	0.1 to 1.0s	Time taken to average the current during start pulse output (1s).
556	Data output mask time	0s	0.0 to 20.0s	Time for not obtaining (mask) transient state data.
557	Current average value monitor signal output reference current	Rated inverter current	0 to 500A	Reference (100%) for outputting the signal of the current average value.

The above parameters can be set when Pr. 160 User group read selection = "0". (Refer to page 197)

The above parameters allow its setting to be changed during operation in any operation mode even if "0" (initial value) is set in Pr. 77 Parameter write selection.

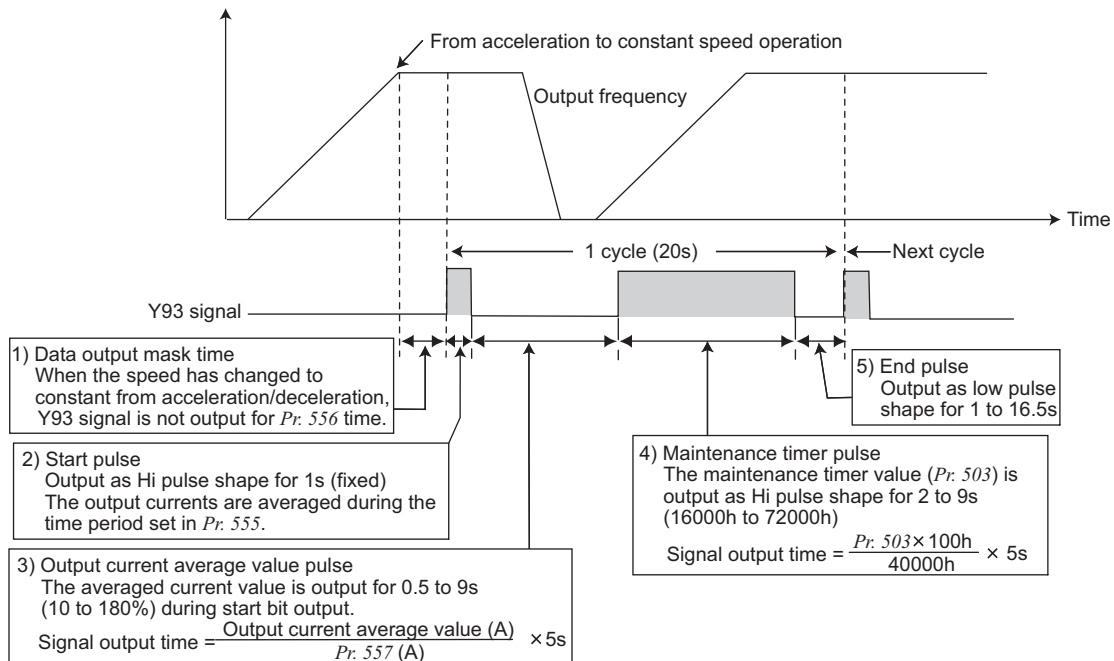

- The pulse output of the current average value monitor signal (Y93) is shown above.
- To assign the Y93 signal to the terminal Y0 or a virtual terminal of CC-Link communication, set "93 (positive logic) or 193 (negative logic)" in one of Pr. 190, Pr. 191 and Pr. 313 to Pr. 315 (output terminal function selection). (The signal cannot be assigned with Pr. 192 RX7 function selection.)

1) Setting of Pr. 556 Data output mask time

The output current is unstable (transient state) right after the operation is changed from the acceleration/deceleration state to the constant speed operation. Set the time for not obtaining (mask) transient state data in Pr. 556.

2) Setting of Pr. 555 Current average time

The average output current is calculated during Hi output of start pulse (1s). Set the time taken to average the current during start bit output in Pr. 555.

3) Setting of Pr. 557 Current average value monitor signal output reference current

Set the reference (100%) for outputting the signal of the current average value. Obtain the time to output the signal from the following calculation.

$$\frac{\text{Output current average value}}{\text{Pr. 557 setting}} \times 5\text{s (Output current average value 100%/5s)}$$

Note that the output time range is 0.5 to 9s and the output time is either of the following values when the output current average value is the corresponding percentage of the Pr. 557 setting.

Less than 10% ... 0.5s, more than 180% ... 9s

Example) when Pr. 557 = 10A and the average value of output current is 15A

As $15A/10A \times 5s=7.5$, the current average value monitor signal is output as low pulse shape for 7.5s.

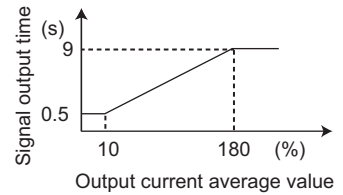

4) Setting of Pr. 503 Maintenance timer

After the output current average value is output as low pulse shape, the maintenance timer value is output as high pulse shape. The output time of the maintenance timer value is obtained from the following calculation.

$$\frac{\text{Pr. 503} \times 100}{40000\text{h}} \times 5\text{s (Maintenance timer value 100%/5s)}$$

Note that the output time range is 2 to 9s, and it is 2s when the Pr. 503 setting is less than 16000h and 9s when exceeds 72000h.

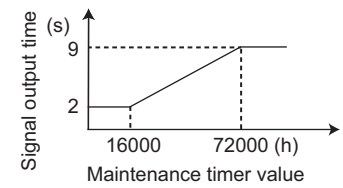

 **REMARKS**

- Mask of data output and sampling of output current are not performed during acceleration/deceleration.
- When the speed is changed to acceleration/deceleration from constant speed during start pulse output, the data is judged as invalid, the start pulse is output as high pulse shape for 3.5s, and the end signal is output as low pulse shape for 16.5s. The signal is output for at least 1 cycle even when acceleration/deceleration state continues after the start pulse output is completed.

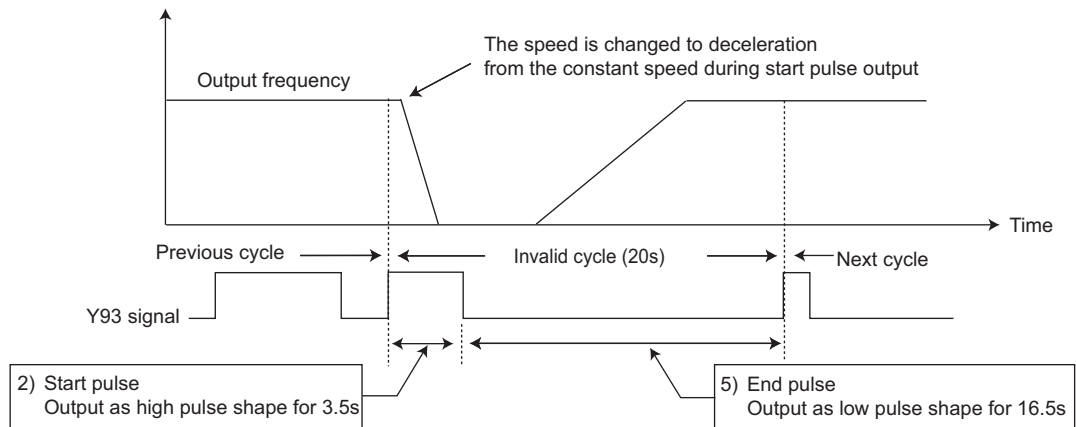



- When the output current value (inverter output current monitor) is 0A on completion of the 1 cycle signal output, the signal is not output until the speed becomes constant next time
- The current average value monitor signal (Y93) is output as low pulse shape for 20s (without data output) under the following condition.
 - (a) When the motor is in the acceleration/deceleration state on completion of the 1 cycle signal output
 - (b) When 1-cycle signal output was ended during restart operation with the setting of automatic restart after instantaneous power failure (Pr. 57 ≠ "9999")
 - (c) When restart operation was being performed at the point of data output mask end with the setting of automatic restart after instantaneous power failure (Pr. 57 ≠ "9999")

 **NOTE**

- Changing the assignment of the terminal Y0 or a virtual terminal of CC-Link communication with one of Pr.190 to Pr.192, and Pr.313 to Pr.315 (output terminal function selection) may affect other functions. Set parameters after confirming the function of the terminal Y0 and virtual terminals.



Parameters referred to

- Pr. 57 Restart coasting time  Refer to page 180
- Pr. 190 to Pr. 192, Pr.313 to Pr.315 (output terminal function selection)  Refer to page 167
- Pr. 503 Maintenance timer  Refer to page 217

5.21.5 USB communication (Pr. 547, Pr. 548, Pr. 551)

Inverter setup can be easily performed using the FR Configurator by connecting the inverter and personal computer with a USB cable.

- A personal computer and inverter can be easily connected with one USB cable.

Parameter Number	Name	Initial Value	Setting Range	Description
547 *1	USB communication station number	0	0 to 31	Inverter station number specification
548 *1	USB communication check time interval	9999	0	USB communication is possible Trips in the PU operation mode (E.USB)
			0.1 to 999.8s	Sets the interval of communication check time. If a no-communication state persists for longer than the permissible time, the inverter trips (E.USB).
			9999	No communication check
551 *2	PU mode operation command source selection	9999	2	For manufacturer setting. Do not set.
			3	USB connector is the command source when PU operation mode.
			4	Operation panel is the command source when PU operation mode.
			9999	USB automatic recognition Normally, operation panel is the command source. When USB is connected, USB connector is the command source.

The above parameters can be set when Pr. 160 User group read selection = "0". (Refer to page 197)

*1 Changed setting value is valid when powering on or resetting the inverter.

*2 This parameter can be changed during a stop in any operation mode.

(1) USB communication specifications

Interface	Conforms to USB1.1
Transmission Speed:	12Mbps
Wiring Length	Maximum 5m
Connector	USB mini B connector (receptacle mini B type)
Power supply	Self-power supply

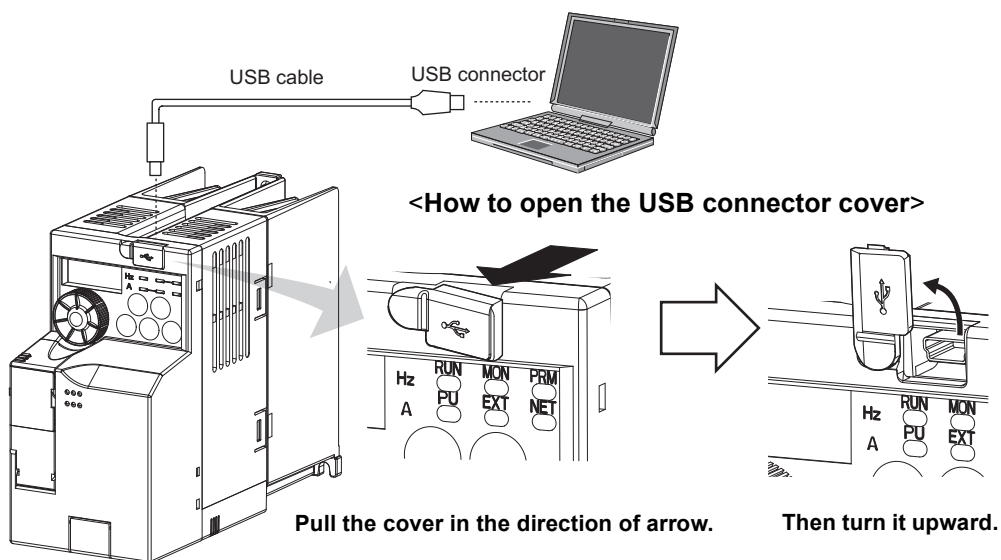

- You can perform parameter setting and monitoring with the FR Configurator. Refer to the instruction manual of the FR Configurator for details.

**REMARKS**



- USB cable available on the market

Name	Model	Application/Specifications	
USB cable	MR-J3USBCBL3M Cable length 3m	Connector for amplifier mini-B connector (5 pin)	Connector for personal computer A connector
			

(2) Select the command source of the PU operation mode (Pr. 551)

- Either the operation panel, or USB connector can be specified as the command source in the PU operation mode.
- You can write parameters and monitor different items with FR Configurator through the USB connector. To do that, set Pr.551 = "9999 (initial value) or 3" in PU operation mode.

**NOTE**

- Changed setting value is valid when powering ON or resetting the inverter.
- All of the operation mode indicator (  ) of the operation panel turns OFF when command source is not operation panel.

PU...PU operation mode, NET...network operation mode, —...without command source

Pr. 551 Setting	Command Source		
	Operation panel	USB connector	CC-Link communication
3	—	PU	NET
4	PU	—	NET
9999 (initial value)	PU *	PU *	NET

* When Pr. 551 = "9999", the priorities of the PU command source is USB connector > operation panel.

5.21.6 Free parameter (Pr. 888, Pr. 889)

You can input any number within the setting range 0 to 9999.

For example, the number can be used:

- As a unit number when multiple units are used.
- As a pattern number for each operation application when multiple units are used.
- As the year and month of introduction or inspection.

Parameter Number	Name	Initial Value	Setting Range	Description
888	Free parameter 1	9999	0 to 9999	Any values can be set. Data is held even if the inverter power is turned OFF.
889	Free parameter 2	9999	0 to 9999	

The above parameters can be set when *Pr. 160 User group read selection = "0"*. (Refer to page 197)

The above parameters allow their settings to be changed during operation in any operation mode even if "0" (initial value) is set in *Pr.77 Parameter write selection*.



REMARKS

Pr. 888 and Pr. 889 do not influence the inverter operation.

5.22 Setting from the operation panel

Purpose	Parameter that should be Set		Refer to Page
Selection of rotation direction by  of the operation panel	RUN key rotation direction selection	Pr. 40	223
Use the setting dial of the operation panel like a potentiometer for frequency setting. Key lock of operation panel	Operation panel operation selection	Pr. 161	224
Change the magnitude of change of frequency setting by the setting dial of the operation panel	Magnitude of frequency change setting	Pr. 295	226

5.22.1 RUN key rotation direction selection (Pr. 40)

Used to choose the direction of rotation by operating  of the operation panel.

Parameter Number	Name	Initial Value	Setting Range	Description
40	RUN key rotation direction selection	0	0	Forward rotation
			1	Reverse rotation

The above parameters can be set when Pr. 160 User group read selection = "0". (Refer to page 197)

5.22.2 Operation panel frequency setting/key lock operation selection (Pr. 161)

The setting dial of the operation panel can be used for setting like a potentiometer.
The key operation of the operation panel can be disabled.

Parameter Number	Name	Initial Value	Setting Range	Description
161	Frequency setting/key lock operation selection	0	0	Setting dial frequency setting
			1	Setting dial potentiometer
			10	Setting dial frequency setting
			11	Setting dial potentiometer
				Key lock invalid
				Key lock valid

The above parameters can be set when Pr. 160 User group read selection = "0". (Refer to page 197)

(1) Using the setting dial like a potentiometer to set the frequency

Operation example Changing the frequency from 0Hz to 60Hz during operation

Operation	Display
1. Screen at power-ON The inverter starts up in Network operation mode. The monitor display appears.	
2. Press PU EXT to choose the PU operation mode.	PU indicator is lit.
3. Press MODE to choose the parameter setting mode.	PRM indicator is lit.
4. Turn until P. 161 (Pr. 161) appears.	
5. Press SET to read the currently set value. "0" (initial value) appears.	
6. Turn to change it to the set value "1".	
7. Press SET to set.	
Flicker ... Parameter setting complete!!	
8. Mode/monitor check Press MODE twice to choose the monitor/frequency monitor.	
9. Press RUN to start the inverter.	
10. Turn until 60.00 appears. The flickering frequency is the set frequency. You need not press SET .	The frequency flickers for about 5s.



REMARKS

- If the display changes from flickering "60.00" to "0.00", the setting of Pr. 161 Frequency setting/key lock operation selection may not be "1".
- Independently of whether the inverter is running or at a stop, the frequency can be set by merely turning the dial.
- When the frequency is changed, it will be stored in EEPROM as the set frequency after 10s.

NOTE

- When setting a frequency by turning the setting dial, the frequency goes up to the set value of Pr.1 Maximum frequency (initial value: 120Hz). Adjust Pr. 1 Maximum frequency setting according to the application.

(2) Disable the setting dial and key operation of the operation panel (Press [MODE] long (2s))

- Operation using the setting dial and key of the operation panel can be invalid to prevent parameter change, and unexpected start or frequency setting.
- Set "10 or 11" in Pr. 161, then press  for 2s to make the setting dial and key operation invalid.
- When the setting dial and key operation are invalid, *HOLD* appears on the operation panel. If dial or key operation is attempted while dial and key operation are invalid, *HOLD* appears. (When dial or key is not touched for 2s, monitor display appears.)
- To make the setting dial and key operation valid again, press  for 2s.

**REMARKS**

- Even if the setting dial and key operation are disabled, the monitor display and  are valid.

**NOTE**

- Release the operation lock to release the PU stop by key operation.

5.22.3 Magnitude of frequency change setting (Pr. 295)

When setting the set frequency with the setting dial, frequency changes in 0.01Hz increments in the initial status. Setting this parameter increases the magnitude of frequency which changes according to the rotated amount of the setting dial, improving operability.

Parameter Number	Name	Initial Value	Setting Range	Description
295	Magnitude of frequency change setting	0	0	Function invalid
			0.01	The minimum varying width when the set frequency is changed by the setting dial can be set.
			0.10	
			1.00	
			10.00	

The above parameter can be set when Pr. 160 User group read selection = "0". (Refer to page 197)

The above parameter allows its setting to be changed during operation in any operation mode even if "0" (initial value) is set in Pr. 77 Parameter write selection.

(1) Basic operation

When a value other than "0" is set in Pr. 295, the minimum varying width when the set frequency is changed by the setting dial can be set.

For example, when "1.00Hz" is set in Pr. 295, one click (one dial gauge) of the setting dial changes the frequency in increments of 1.00Hz→2.00Hz→3.00Hz.

When Pr. 295 = "1"

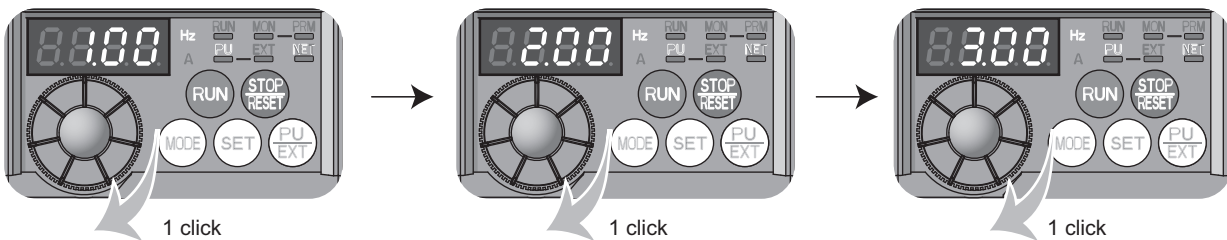

*One rotation of the setting dial equals to 24 clicks (24 dial gauges).

REMARKS

- When machine speed display is selected with Pr. 37, the minimum increments of the magnitude of change is determined by Pr. 295 as well. Note that the setting value may differ as speed setting changes the set machine speed and converts it to the speed display again.
- When the set frequency (speed) is 100 or more, frequency is displayed in 0.1 increments. Therefore, the minimum varying width is 0.1 even when Pr. 295 < 0.1.
- When the machine speed setting is 1000 or more, frequency is displayed in 1 increments. Therefore, the minimum varying width is 1 even when Pr. 295 < 1.

NOTE

- For Pr. 295, unit is not displayed.
- This parameter is valid only in the set frequency mode. When other frequency-related parameters are set, it is not activated.
- When 10 is set, frequency setting changes in 10Hz increments. Note the excess speed (in potentiometer mode).

5.23 Parameter clear/ All parameter clear



POINT

- Set "1" in *Pr.CL* Parameter clear, *ALLC* all parameter clear to initialize all parameters. (Parameters are not cleared when "1" is set in *Pr. 77*Parameter write selection.)
- Refer to the extended parameter list on page 84 for parameters cleared with this operation.

Operation

1. Screen at power-ON
The inverter starts up in Network operation mode.
The monitor display appears.
2. Press **PU EXT** to choose the PU operation mode.
3. Press **MODE** to choose the parameter setting mode.
4. Turn **▲** until *Pr.CL (ALLC)* appears.
5. Press **SET** to read the currently set value.
"0"(initial value) appears.
6. Turn **▲** to change it to the set value "1".
7. Press **SET** to set.

Display



PU indicator is lit.



PRM indicator is lit.



(The parameter number read previously appears.)

Parameter clear



All parameter clear



Parameter clear



All parameter clear



Flicker ... Parameter setting complete!!

- Turn **▲** to read another parameter.
- Press **SET** to show the setting again.
- Press **SET** twice to show the next parameter.

Setting	Description
0	Not executed.
1	Set parameters back to the initial values. (Parameter clear sets back all parameters except <i>terminal function selection parameters</i> to the initial values.) Refer to the parameter list on page 84 for availability of parameter clear and all parameter clear.



REMARKS

? **1** and **Er4** are displayed alternately ... Why?

- ☞ The inverter is not in the PU operation mode.
- ☞ USB connector is used.

1. Press **PU EXT**. [PU] is lit and the monitor (4-digit LED) displays "1". (When *Pr. 79* = "0" (initial value))
2. Carry out operation from step 6 again.

5.24 Initial value change list

Displays and sets the parameters changed from the initial value.

Operation	Display
1. Screen at power-ON The inverter starts up in Network operation mode. The monitor display appears.	
2. Press (PU EXT) to choose the PU operation mode.	PU indicator is lit.
3. Press (MODE) to choose the parameter setting mode.	PRM indicator is lit. (The parameter number read previously appears.)
4. Turn (rotary knob) until Pr.CH appears.	
5. Pressing (SET) changes to the initial value change list screen.	* It may take several seconds for creating the initial value change list. "P. ---" flickers while creating the list.
6. Turning (rotary knob) displays the parameter number changed.	
• Press (SET) to read the currently set value.	
Turn (rotary knob) and press (SET) to change the setting (Refer to steps 6 and 7 on page 82)	
• Turn (rotary knob) to read another parameter.	
• The display returns to P. --- after all parameters are displayed.	
7. Pressing (SET) in P. --- status returns to the parameter setting mode.	
• Turning (rotary knob) sets other parameters.	
• Pressing (SET) displays the change list again.	



NOTE

- Only simple mode parameter is displayed when simple mode is set (Pr. 160 = 9999)
- Only user group is displayed when user group is set (Pr. 160 = "1").
- Pr. 160 is displayed independently of whether the setting value is changed or not.
- When parameter setting is changed after creating the initial value change list, the setting will be reflected to the initial value change list next time.



Parameters referred to

Pr. 160 User group read selection Refer to page 197

5.25 Check and clear of the faults history

(1) Check for the faults history

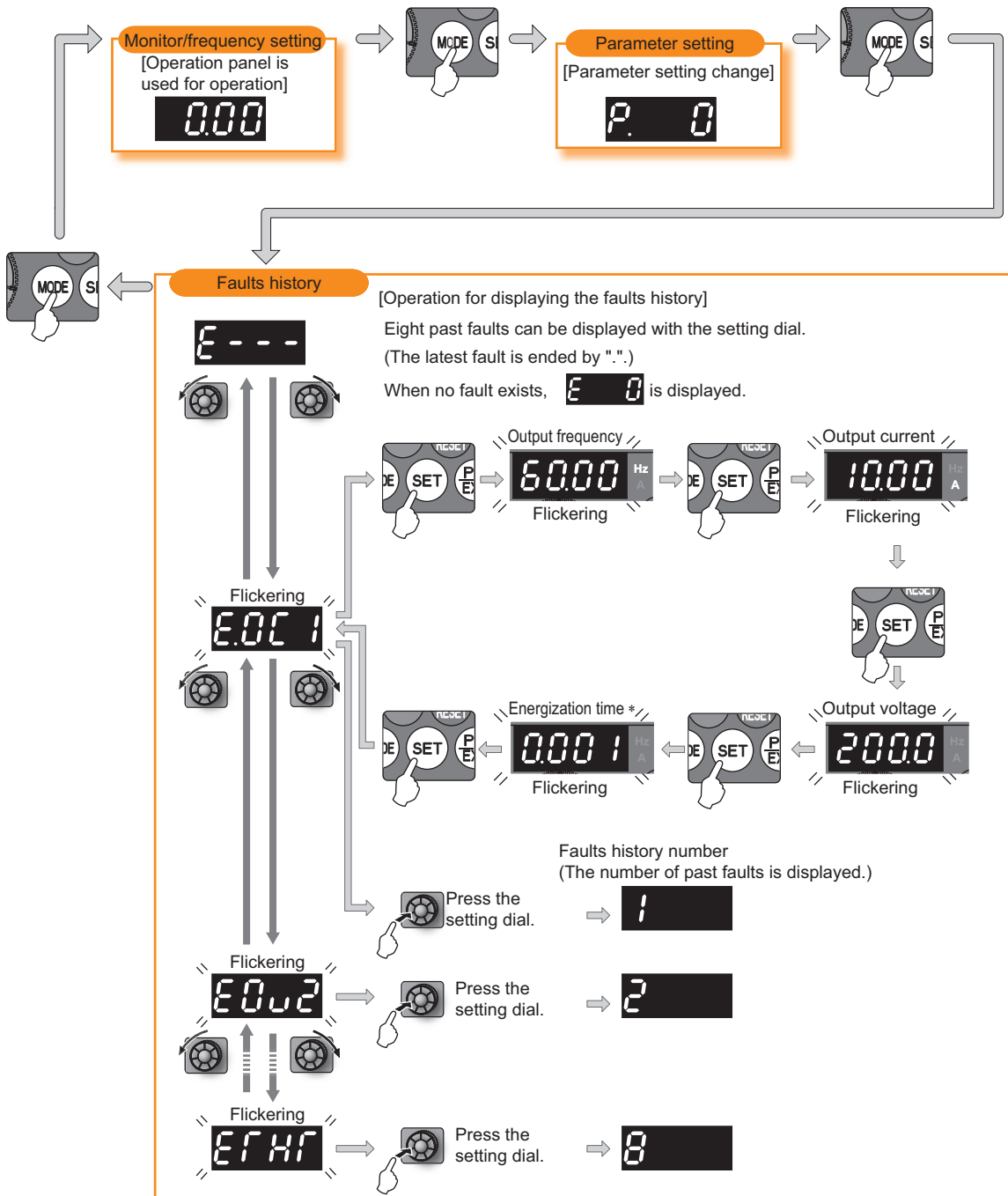

* The cumulative energization time and actual operation time are accumulated from 0 to 65535 hours, then cleared, and accumulated again from 0. When the operation panel is used, the time is displayed up to 65.53 (65530h) in the indication of 1h = 0.001, and thereafter, it is added up from 0.



(2) Clearing procedure



POINT

- Set "1" in *Er.CL Fault history clear* to clear the faults history.

Operation

1. Screen at power-ON
The inverter starts up in Network operation mode.
The monitor display appears.
2. Press **MODE** to choose the parameter setting mode.
3. Turn  until *Er.CL* (faults history clear) appears.
4. Press **SET** to read the currently set value. "0" (initial value) appears.
5. Turn  to change it to the set value "1".
6. Press **SET** to set.



Display



PRM indicator is lit.



(The parameter number read previously appears.)



Flicker...Faults history clear complete!!

- Turn  to read another parameter.
- Press **SET** to show the setting again.
- Press **SET** twice to show the next parameter.



Parameters referred to

Pr: 77 Parameter write selection  Refer to page 196

6 TROUBLESHOOTING

This chapter provides the "TROUBLESHOOTING" of this product.
Always read the instructions before using the equipment.

6.1	Reset method of protective function	232
6.2	List of fault or alarm indications	233
6.3	Causes and corrective actions	234
6.4	Correspondences between digital and actual characters	243
6.5	Check first when you have a trouble	244

1

2

3

4

5

6

7

8

Reset method of protective function

When a fault occurs in the inverter, the inverter trips and the operation panel display automatically changes to one of the following fault or alarm indications.

If the fault does not correspond to any of the following faults or if you have any other problem, please contact your sales representative.

- Retention of fault output signal .. When the magnetic contactor (MC) provided on the input side of the inverter is opened when a fault occurs, the inverter's control power will be lost and the fault output will not be held.
- Fault or alarm indication When a fault or alarm occurs, the operation panel display automatically switches to the fault or alarm indication.
- Resetting method When a fault occurs, the inverter output is kept stopped. Unless reset, therefore, the inverter cannot restart. (Refer to page 232)
- When any fault occurs, take the appropriate corrective action, then reset the inverter, and resume operation.
Not doing so may lead to the inverter fault and damage.

Inverter fault or alarm indications are roughly categorized as below.

- (1) Error message
A message regarding operational fault and setting fault by the operation panel is displayed. The inverter does not trip.
- (2) Warning
The inverter does not trip even when a warning is displayed. However, failure to take appropriate measures will lead to a fault.
- (3) Alarm
The inverter does not trip. You can also output an alarm signal by making parameter setting.
- (4) Fault
When a fault occurs, the inverter trips and a fault signal is output.

REMARKS

- Past eight faults can be displayed using the setting dial.

6.1 Reset method of protective function

(1) Resetting the inverter

The inverter can be reset by performing any of the following operations. Note that the internal thermal integrated value of the electronic thermal relay function and the number of retries are cleared (erased) by resetting the inverter.

Inverter recovers about 1s after the reset is released.

Operation 1: Using the operation panel, press  to reset the inverter.

(This may only be performed when a fault occurs (Refer to page 237 for fault.))

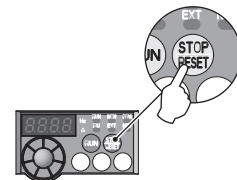

Operation 2: Write HFD (inverter reset) to an instruction code of CC-Link communication.

(Inverter reset though CC-Link communication is invalid during communication error.)

Operation 3: Switch power OFF once. After the indicator of the operation panel turns OFF, switch it ON again.

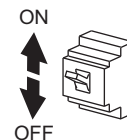

REMARKS

- Use the operation 1 or 2 to reset when using the 24V external power supply.

NOTE

- OFF status of the start signal must be confirmed before resetting the inverter fault. Resetting inverter fault with the start signal ON restarts the motor suddenly.



6.2 List of fault or alarm indications

Operation Panel Indication		Name	Refer to Page	Operation Panel Indication		Name	Refer to Page		
Error message	E---	E---	Faults history	229	Fault	EILF	E.ILF	Input phase loss	239
	HOLD	HOLD	Operation panel lock	234		EOLT	E.OLT	Stall prevention stop	240
	LOCd	LOCD	Password locked	234		E.bE	E. BE	Brake transistor alarm detection	240
	Er1	Er1	Parameter write error	234		E.GF	E.GF	Output side earth (ground) fault overcurrent at start	240
	Er2	Er2				E.LF	E.LF	Output phase loss	240
	Er4	Er4				E.OP1	E.OP1	Communication option fault	240
Err.	Err.	Inverter reset	234	E.OPF		E.OPT	Option fault	241	
Warning	OL	OL	Stall prevention (overcurrent)	235		E. 1	E. 1	Option fault	241
	oL	oL	Stall prevention (overvoltage)	235		E. PE	E.PE	Parameter storage device fault	241
	rb	RB	Regenerative brake prealarm	236		E.PE2	E.PE2	Internal board fault	241
	TH	TH	Electronic thermal relay function prealarm	236		ErEr	E.RET	Retry count excess	241
	PS	PS	PU stop	235		E. 5 E. 6 E. 7 E.CPU	E. 5 E. 6 E. 7 E.CPU	CPU fault	241
	MT	MT	Maintenance signal output	236					
	UV	UV	Undervoltage	236					
	SA	SA	Safety stop	236					
	EV	EV	24V external power supply operation	237		E.IOH	E.IOH	Inrush current limit circuit fault	242
Alarm	F _n	FN	Fan alarm	237		E.USB	E.USB	USB communication fault	242
Fault	E.OC1	E.OC1	Overcurrent trip during acceleration	237		E.MB4 to E.MB7	E.MB4 to E.MB7	Brake sequence fault	242
	E.OC2	E.OC2	Overcurrent trip during constant speed	237	E.SAF	E.SAF	Safety circuit fault	242	
	E.OC3	E.OC3	Overcurrent trip during deceleration or stop	238	E. 13	E.13	Internal circuit fault	242	
	E.OV1	E.OV1	Regenerative overvoltage trip during acceleration	238					
	E.OV2	E.OV2	Regenerative overvoltage trip during constant speed	238					
	E.OV3	E.OV3	Regenerative overvoltage trip during deceleration or stop	238					
	E.THT	E.THT	Inverter overload trip (electronic thermal relay function)	239					
	E.THM	E.THM	Motor overload trip (electronic thermal relay function)	239					
	E.FIN	E.FIN	Heatsink overheat	239					

6.3 Causes and corrective actions

(1) Error message

A message regarding operational troubles is displayed. Output is not shutoff.

Operation panel indication	HOLD	HOLD
Name	Operation panel lock	
Description	Operation lock mode is set. Operation other than  is invalid. (Refer to page 225)	
Check point	—	
Corrective action	Press  for 2s to release lock.	

Operation panel indication	LOCD	LOCD
Name	Password locked	
Description	Password function is active. Display and setting of parameter is restricted.	
Check point	—	
Corrective action	Enter the password in Pr. 297 Password lock/unlock to unlock the password function before operating. (Refer to page 199).	

Operation panel indication	Er1	Er 1
Name	Write disable error	
Description	<ul style="list-style-type: none"> You attempted to make parameter setting when Pr. 77 Parameter write selection has been set to disable parameter write. Frequency jump setting range overlapped. 	
Check point	<ul style="list-style-type: none"> Check the setting of Pr. 77 Parameter write selection. (Refer to page 196). Check the settings of Pr. 31 to Pr. 36 (frequency jump). (Refer to page 125) 	

Operation panel indication	Er2	Er 2
Name	Write error during operation	
Description	When parameter write was performed during operation with a value other than "2" (writing is enabled independently of operation status in any operation mode) is set in Pr. 77 and the STF (STR) is ON.	
Check point	<ul style="list-style-type: none"> Check the Pr. 77 setting. (Refer to page 196). Check that the inverter is not operating. 	
Corrective action	<ul style="list-style-type: none"> Set "2" in Pr. 77. After stopping operation, make parameter setting. 	

Operation panel indication	Er4	Er 4
Name	Mode designation error	
Description	Appears if a parameter setting is attempted in the NET operation mode with Pr. 77 ≠ "2".	
Check point	<ul style="list-style-type: none"> Check that operation mode is PU operation mode. Check the Pr. 77 setting. (Refer to page 196). 	
Corrective action	<ul style="list-style-type: none"> After setting the operation mode to the "PU operation mode", make parameter setting. (Refer to page 103) After setting Pr. 77 = "2", make parameter setting. 	





Operation panel indication	Err.	Err.
Name	Inverter reset	
Description	<ul style="list-style-type: none"> Appears at the execution of a reset command, which is given via CC-Link communication or from  on the operation panel. Appears at powering OFF. 	
Corrective action	<ul style="list-style-type: none"> Turn OFF the reset command 	

(2) Warning

When a warning occurs, the output is not shut off.

Operation panel indication	OL	
Name	Stall prevention (overcurrent)	
Description	During acceleration	When the output current (output torque when <i>Pr. 277 Stall prevention current switchover = "1"</i>) of the inverter exceeds the stall prevention operation level (<i>Pr. 22 Stall prevention operation level, etc.</i>), this function stops the increase in frequency until the overload current decreases to prevent the inverter from resulting in overcurrent trip. When the overload current has reduced below stall prevention operation level, this function increases the frequency again.
	During constant-speed operation	When the output current (output torque when <i>Pr. 277 Stall prevention current switchover = "1"</i>) of the inverter exceeds the stall prevention operation level (<i>Pr. 22 Stall prevention operation level, etc.</i>), this function reduces frequency until the overload current decreases to prevent the inverter from resulting in overcurrent trip. When the overload current has reduced below stall prevention operation level, this function increases the frequency up to the set value.
	During deceleration	When the output current (output torque when <i>Pr. 277 Stall prevention current switchover = "1"</i>) of the inverter exceeds the stall prevention operation level (<i>Pr. 22 Stall prevention operation level, etc.</i>), this function stops the decrease in frequency until the overload current decreases to prevent the inverter from resulting in overcurrent trip. When the overload current has decreased below stall prevention operation level, this function decreases the frequency again.
Check point	<ul style="list-style-type: none"> • Check that the <i>Pr. 0 Torque boost</i> setting is not too large. • Check that the <i>Pr. 7 Acceleration time</i> and <i>Pr. 8 Deceleration time</i> settings are not too small. • Check that the load is not too heavy. • Are there any failure in peripheral devices? • Check that the <i>Pr. 13 Starting frequency</i> is not too large. • Check that the <i>Pr. 22 Stall prevention operation level</i> is appropriate 	
Corrective action	<ul style="list-style-type: none"> • Increase or decrease the <i>Pr. 0 Torque boost</i> setting 1% by 1% and check the motor status. (<i>Refer to page 113</i>) • Set a larger value in <i>Pr. 7 Acceleration time</i> and <i>Pr. 8 Deceleration time</i>. (<i>Refer to page 135</i>) • Reduce the load weight. • Try Advanced magnetic flux vector control and General-purpose magnetic flux vector control. • Change the <i>Pr. 14 Load pattern selection</i> setting. • Set stall prevention operation current in <i>Pr. 22 Stall prevention operation level</i>. (The initial value is 150%.) The acceleration/deceleration time may change. Increase the stall prevention operation level with <i>Pr. 22 Stall prevention operation level</i>, or disable stall prevention with <i>Pr. 156 Stall prevention operation selection</i>. (Operation at OL occurrence can be selected using <i>Pr. 156</i>.) 	

Operation panel indication	oL	
Name	Stall prevention (overvoltage)	
Description	During deceleration	<ul style="list-style-type: none"> • If the regenerative energy of the motor becomes excessive to exceed the regenerative energy consumption capability, this function stops the decrease in frequency to prevent overvoltage trip. As soon as the regenerative energy has reduced, deceleration resumes.
		<ul style="list-style-type: none"> • If the regenerative energy of the motor becomes excessive when regeneration avoidance function is selected (<i>Pr. 882 = 1</i>), this function increases the speed to prevent overvoltage trip. (<i>Refer to page 211</i>).
Check point	<ul style="list-style-type: none"> • Check for sudden speed reduction. • Check that regeneration avoidance function (<i>Pr. 882, Pr. 883, Pr. 885, Pr. 886</i>) is used. (<i>Refer to page 211</i>). 	
Corrective action	The deceleration time may change. Increase the deceleration time using <i>Pr. 8 Deceleration time</i> .	

Operation panel indication	PS	
Name	PU stop	
Description	Stop with  on the operation panel is set in <i>Pr. 75 Reset selection/PU stop selection</i> . (For <i>Pr. 75</i> , refer to page 194.)	
Check point	Check for a stop made by pressing  on the operation panel.	
Corrective action	Turn the start signal OFF and release with  .	

Causes and corrective actions



Operation panel indication	RB	rb
Name	Regenerative brake prealarm	
Description	Appears if the regenerative brake duty reaches or exceeds 85% of the <i>Pr. 70 Special regenerative brake duty</i> value. When the setting of <i>Pr. 70 Special regenerative brake duty</i> is the initial value (<i>Pr. 70</i> = "0"), this warning does not occur. If the regenerative brake duty reaches 100%, a regenerative overvoltage (E. OV_) occurs. The RBP signal can be simultaneously output with the [RB] display. To assign the RBP signal to the terminal Y0 or a virtual terminal of CC-Link communication, set "7 (positive logic) or 107 (negative logic)" in one of <i>Pr.190 to Pr.192 and Pr.313 to Pr.315 (output terminal function selection)</i> . (Refer to page 167).	
Check point	<ul style="list-style-type: none"> Check that the brake resistor duty is not high. Check that the <i>Pr. 30 Regenerative function selection</i> and <i>Pr. 70 Special regenerative brake duty</i> settings are correct. 	
Corrective action	<ul style="list-style-type: none"> Increase the deceleration time. Check that the <i>Pr. 30 Regenerative function selection</i> and <i>Pr. 70 Special regenerative brake duty</i> settings. 	

Operation panel indication	TH	TH
Name	Electronic thermal relay function prealarm	
Description	Appears if the cumulative value of the <i>Pr. 9 Electronic thermal O/L relay</i> reaches or exceeds 85% of the preset level. If it reaches 100% of the <i>Pr. 9 Electronic thermal O/L relay</i> setting, a motor overload trip (E. THM) occurs. The THP signal can be simultaneously output with the [TH] display. To assign the THP signal to the terminal Y0 or a virtual terminal of CC-Link communication, set "8 (positive logic) or 108 (negative logic)" in one of <i>Pr.190 to Pr.192 and Pr.313 to Pr.315 (output terminal function selection)</i> . (Refer to page 167).	
Check point	<ul style="list-style-type: none"> Check for large load or sudden acceleration. Is the <i>Pr. 9 Electronic thermal O/L relay</i> setting is appropriate? (Refer to page 142) 	
Corrective action	<ul style="list-style-type: none"> Reduce the load and frequency of operation. Set an appropriate value in <i>Pr. 9 Electronic thermal O/L relay</i>. (Refer to page 142) 	

Operation panel indication	MT	MT
Name	Maintenance signal output	
Description	Indicates that the cumulative energization time of the inverter has reached a given time. When the setting of <i>Pr. 504 Maintenance timer alarm output set time</i> is the initial value (<i>Pr. 504</i> = "9999"), this warning does not occur.	
Check point	The <i>Pr. 503 Maintenance timer</i> setting is larger than the <i>Pr. 504 Maintenance timer alarm output set time</i> setting. (Refer to page 217).	
Corrective action	Setting "0" in <i>Pr. 503 Maintenance timer</i> erases the signal.	



Operation panel indication	UV	Uu
Name	Undervoltage	
Description	If the power supply voltage of the inverter decreases, the control circuit will not perform normal functions. In addition, the motor torque will be insufficient and/or heat generation will increase. To prevent this, if the power supply voltage decreases below about 115VAC (about 230VAC for 400V class), this function stops the inverter output and displays Uu. An alarm is reset when the voltage returns to normal.	
Check point	Check that the power supply voltage is normal.	
Corrective action	Check the power supply system equipment such as power supply.	

Operation panel indication	SA	SA
Name	Safety stop	
Description	Appears when safety stop function is activated (during output shutoff). (Refer to page 24)	
Check point	If the indication appears when safety stop function is not used, check that shorting wires between S1 and PC, S2 and PC are connected.	
Corrective action	<ul style="list-style-type: none"> When not using the safety stop function, short across terminals S1 and PC and across S2 and PC with shorting wire for the inverter to run. If $\overline{S_1}$ is indicated when across S1 and PC and across S2 and PC are both shorted while using the safety stop function (drive enabled), internal failure might be the cause. Check the wiring of terminals S1, S2 and PC and contact your sales representative if the wiring has no fault. 	

Operation panel indication	EV	
Name	24V external power supply operation	
Description	Flickers when the main circuit power is not supplied and the 24V external power is supplied.	
Check point	<ul style="list-style-type: none"> • Check if the 24V external power is supplied. • Check if the power supply for the inverter (main circuit) is ON. Check if the power supply voltage is low. • Check if the jumper between terminal P/+ and P1 is removed. 	
Corrective action	<ul style="list-style-type: none"> • Turn ON the power supply for the inverter (main circuit). • If  appears by turning ON the power supply of the inverter (main circuit) while the external 24V power is supplied, check the power supply (for the main circuit). • Check if the jumper is installed securely between terminal P/+ and P1. 	

(3) Alarm

When an alarm occurs, the output is not shut off. You can also output an alarm signal by making parameter setting. (Set "98" in any of Pr. 190 to Pr. 192, Pr. 313 to Pr. 315 (output terminal function selection). Refer to page 167).

Operation panel indication	FN	
Name	Fan alarm	
Description	For the inverter that contains a cooling fan,  appears on the operation panel when the cooling fan stops due to an alarm or different operation from the setting of Pr. 244 Cooling fan operation selection.	
Check point	Check the cooling fan for an alarm.	
Corrective action	Check for fan alarm. Please contact your sales representative.	

(4) Fault

When a fault occurs, the inverter trips and a fault signal is output.

Operation panel indication	E.OC1	
Name	Overcurrent trip during acceleration	
Description	When the inverter output current reaches or exceeds approximately 230% of the rated current during acceleration, the protective circuit is activated and the inverter trips.	
Check point	<ul style="list-style-type: none"> • Check for sudden acceleration. • Check that the downward acceleration time is not long for lifts. • Check for output short-circuit/ground fault. • Check that the Pr. 3 Base frequency setting is not 60Hz when the motor rated frequency is 50Hz. • Check if the stall prevention operation level is set too high. • Check if the fast-response current limit operation is disabled. • Check that regeneration is not performed frequently. (Check that the output voltage becomes larger than the V/F reference value at regeneration and overcurrent occurs due to the high voltage.) 	
Corrective action	<ul style="list-style-type: none"> • Increase the acceleration time. (Shorten the downward acceleration time for lifts.) • When "E.OC1" is always lit at starting, disconnect the motor once and start the inverter. If "E.OC1" is still lit, contact your sales representative. • Check the wiring to make sure that output short circuit/ground fault does not occur. • Set 50Hz in Pr. 3 Base frequency. (Refer to page 126) • Lower the setting of stall prevention operation level. • Activate the fast-response current limit operation. (Refer to page 120) • Set base voltage (rated voltage of the motor, etc.) in Pr. 19 Base frequency voltage. (Refer to page 126) 	

Operation panel indication	E.OC2	
Name	Overcurrent trip during constant speed	
Description	When the inverter output current reaches or exceeds approximately 230% of the rated current during constant speed operation, the protective circuit is activated and the inverter trips.	
Check point	<ul style="list-style-type: none"> • Check for sudden load change. • Check for output short-circuit/ground fault. • Check if the stall prevention operation level is set too high. • Check if the fast-response current limit operation is disabled. 	
Corrective action	<ul style="list-style-type: none"> • Keep load stable. • Check the wiring to make sure that output short circuit/ground fault does not occur. • Lower the setting of stall prevention operation level. • Activate the fast-response current limit operation. (Refer to page 120) 	

Operation panel indication	E.OC3	E.Oc3
Name	Overcurrent trip during deceleration or stop	
Description	When the inverter output current reaches or exceeds approximately 230% of the rated inverter current during deceleration (other than acceleration or constant speed), the protective circuit is activated and the inverter trips.	
Check point	<ul style="list-style-type: none"> • Check for sudden speed reduction. • Check for output short-circuit/ground fault. • Check for too fast operation of the motor's mechanical brake. • Check if the stall prevention operation level is set too high. • Check if the fast-response current limit operation is disabled. 	
Corrective action	<ul style="list-style-type: none"> • Increase the deceleration time. • Check the wiring to make sure that output short circuit/ground fault does not occur. • Check the mechanical brake operation. • Lower the setting of stall prevention operation level. • Activate the fast-response current limit operation. (Refer to page 120) 	

Operation panel indication	E.OV1	E.Ov1
Name	Regenerative overvoltage trip during acceleration	
Description	If regenerative energy causes the inverter's internal main circuit DC voltage to reach or exceed the specified value, the protective circuit is activated and the inverter trips. The circuit may also be activated by a surge voltage produced in the power supply system.	
Check point	<ul style="list-style-type: none"> • Check for too slow acceleration. (e.g. during downward acceleration in vertical lift load) • Check that the setting of <i>Pr. 22 Stall prevention operation level</i> is not too small. 	
Corrective action	<ul style="list-style-type: none"> • Decrease the acceleration time. • Check that regeneration avoidance function (<i>Pr. 882, Pr. 883, Pr. 885, Pr. 886</i>) is used. (Refer to page 211). • Set the <i>Pr.22 Stall prevention operation level</i> correctly. 	

Operation panel indication	E.OV2	E.Ov2
Name	Regenerative overvoltage trip during constant speed	
Description	If regenerative energy causes the inverter's internal main circuit DC voltage to reach or exceed the specified value, the protective circuit is activated to stop the inverter output. The circuit may also be activated by a surge voltage produced in the power supply system.	
Check point	<ul style="list-style-type: none"> • Check for sudden load change. • Check that the setting of <i>Pr. 22 Stall prevention operation level</i> is not too small. 	
Corrective action	<ul style="list-style-type: none"> • Keep load stable. • Check that regeneration avoidance function (<i>Pr. 882, Pr. 883, Pr. 885, Pr. 886</i>) is used. (Refer to page 211). • Use the brake resistor or brake unit as required. • Set the <i>Pr.22 Stall prevention operation level</i> correctly. 	

Operation panel indication	E.OV3	E.Ov3
Name	Regenerative overvoltage trip during deceleration or stop	
Description	If regenerative energy causes the inverter's internal main circuit DC voltage to reach or exceed the specified value, the protective circuit is activated to stop the inverter output. The circuit may also be activated by a surge voltage produced in the power supply system.	
Check point	Check for sudden speed reduction.	
Corrective action	<ul style="list-style-type: none"> • Increase the deceleration time. (Set the deceleration time which matches the moment of inertia of the load) • Longer the brake cycle. • Use regeneration avoidance function (<i>Pr. 882, Pr. 883, Pr. 885, Pr. 886</i>). (Refer to page 211). • Use the brake resistor or brake unit as required. 	

Operation panel indication	E.THT	E.THT
Name	Inverter overload trip (electronic thermal relay function)	
Description	If the temperature of the output transistor element exceeds the protection level under the condition that a current not less than the rated inverter current flows and overcurrent trip does not occur (230% or less), the electronic thermal relay activates to stop the inverter output. (Overload capacity 150% 60s, 200% 3s)	
Check point	<ul style="list-style-type: none"> • Check that acceleration/deceleration time is not too short. • Check that torque boost setting is not too large (small). • Check that load pattern selection setting is appropriate for the load pattern of the using machine. • Check the motor for use under overload. • Check for too high surrounding air temperature. 	
Corrective action	<ul style="list-style-type: none"> • Increase acceleration/deceleration time. • Adjust the torque boost setting. • Set the load pattern selection setting according to the load pattern of the using machine. • Reduce the load weight. • Set the surrounding air temperature to within the specifications. 	

Operation panel indication	E.THM	E.THM
Name	Motor overload trip (electronic thermal relay function) *1	
Description	The electronic thermal relay function in the inverter detects motor overheat due to overload or reduced cooling capability during constant-speed operation and pre-alarm (TH display) is output when the integrated value reaches 85% of the <i>Pr. 9 Electronic thermal O/L relay</i> setting and the protection circuit is activated to stop the inverter output when the integrated value reaches the specified value. When running a special motor such as a multi-pole motor or multiple motors, provide a thermal relay on the inverter output side since such motor(s) cannot be protected by the electronic thermal relay function.	
Check point	<ul style="list-style-type: none"> • Check the motor for use under overload. • Check that the setting of <i>Pr. 71 Applied motor</i> for motor selection is correct. (Refer to page 144). • Check that stall prevention operation setting is correct. 	
Corrective action	<ul style="list-style-type: none"> • Reduce the load weight. • For a constant-torque motor, set the constant-torque motor in <i>Pr. 71 Applied motor</i>. • Check that stall prevention operation setting is correct. (Refer to page 120). 	

*1 Resetting the inverter initializes the internal thermal integrated data of the electronic thermal relay function.

Operation panel indication	E.FIN	E.FIN
Name	Heatsink overheat	
Description	If the heatsink overheats, the temperature sensor is actuated and the inverter trips. The FIN signal can be output when the temperature becomes approximately 85% of the heatsink overheat protection operation temperature. For the terminal used for the FIN signal output, assign the function by setting "26 (positive logic) or 126 (negative logic)" in any of <i>Pr. 190 to Pr. 192, Pr. 313 to Pr. 315 (output terminal function selection)</i> . (Refer to page 167).	
Check point	<ul style="list-style-type: none"> • Check for too high surrounding air temperature. • Check for heatsink clogging. • Check that the cooling fan is not stopped (Check that F_n is not displayed on the operation panel). 	
Corrective action	<ul style="list-style-type: none"> • Set the surrounding air temperature to within the specifications. • Clean the heatsink. • Replace the cooling fan. 	

Operation panel indication	E.ILF	E.ILF
Name	Input phase loss *	
Description	Inverter trips when function valid setting (=1) is selected in <i>Pr. 872 Input phase loss protection selection</i> and one phase of the three phase power input is lost. (Refer to page 190). It may be available if phase-to-phase voltage of the three-phase power input becomes largely unbalanced.	
Check point	<ul style="list-style-type: none"> • Check for a break in the cable for the three-phase power supply input. • Check that phase-to-phase voltage of the three-phase power input is not largely unbalanced. 	
Corrective action	<ul style="list-style-type: none"> • Wire the cables properly. • Repair a break portion in the cable. • Check the <i>Pr. 872 Input phase loss protection selection</i> setting. • Set <i>Pr. 872</i> = "0" (without input phase loss protection) when three-phase input voltage is largely unbalanced. 	

* Available only for three-phase power input model.

7 Causes and corrective actions

Operation panel indication	E.OLT	E.OLT
Name	Stall prevention stop	
Description	If the output frequency has fallen to 1Hz by stall prevention operation and remains for 3s, a fault (E.OLT) appears and trips the inverter. OL appears while stall prevention is being activated. E.OLT may not occur if stall prevention (OL) is activated during output phase loss.	
Check point	<ul style="list-style-type: none"> • Check the motor for use under overload. (Refer to page 121). 	
Corrective action	<ul style="list-style-type: none"> • Reduce the load weight. (Check the Pr. 22 Stall prevention operation level setting.) 	

Operation panel indication	E.BE	E. bE
Name	Brake transistor alarm detection	
Description	When a brake transistor alarm has occurred due to the large regenerative energy from the motor etc., the brake transistor alarm is detected and the inverter trips. <u>In this case, the inverter must be powered OFF immediately.</u>	
Check point	<ul style="list-style-type: none"> • Reduce the load inertia. • Check that the frequency of using the brake is proper. 	
Corrective action	Replace the inverter.	

Operation panel indication	E.GF	E. GF
Name	Output side earth (ground) fault overcurrent at start	
Description	The inverter trips if an earth (ground) fault overcurrent flows at start due to an earth (ground) fault that occurred on the inverter's output side (load side). Whether this protective function is used or not is set with Pr. 249 Earth (ground) fault detection at start. When the setting of Pr. 249 Earth (ground) fault detection at start is the initial value (Pr. 249 = "0"), this warning does not occur.	
Check point	Check for a ground fault in the motor and connection cable.	
Corrective action	Remedy the ground fault portion.	

Operation panel indication	E.LF	E. LF
Name	Output phase loss	
Description	If one of the three phases (U, V, W) on the inverter's output side (load side) is lost during inverter operation (except during DC injection brake operation and when output frequency is under 1Hz), inverter stops the output. Whether the protective function is used or not is set with Pr. 251 Output phase loss protection selection.	
Check point	<ul style="list-style-type: none"> • Check the wiring. (Check that the motor is normal.) • Check that the capacity of the motor used is not smaller than that of the inverter. 	
Corrective action	<ul style="list-style-type: none"> • Wire the cables properly. • Check the Pr. 251 Output phase loss protection selection setting. 	

Operation panel indication	E.OP1	E.OP 1
Name	Communication option fault	
Description	This function stops the inverter output when a communication line error occurs during CC-Link communication.	
Check point	<ul style="list-style-type: none"> • Check if a fault is displayed on the inverter LED display. • Check if the CC-Link dedicated cable has a break in it. • Check if the CC-Link dedicated cables between stations are within the specified length. (Refer to the instruction manual of CC-Link master module for the cable length between CC-Link Ver. 1.00 stations.) • Check if the built-in terminating resistor of the end station is turned ON, or if the one-touch connector plug equipped with terminating resistor is attached properly. 	
Corrective action	<ul style="list-style-type: none"> • Refer to "Operation status indication LEDs" on page 75, and perform appropriate countermeasures. • Check the connection of the CC-Link dedicated cable. • Check that the CC-Link dedicated cables between stations are within the specified length. (Refer to the instruction manual of CC-Link master module for the cable length between CC-Link Ver. 1.00 stations.) • Turn ON the built-in terminating resistor of the end station. Alternatively, properly attach the one-touch connector plug equipped with terminating resistor. 	

Operation Panel Indication	E.OPT	E.OPT
Name	Option fault	
Description	Appears when a communication option is connected while Pr. 296 = "0 or 100."	
Check point	Check if password lock is activated by setting Pr. 296 = "0, 100"	
Corrective action	<ul style="list-style-type: none"> To apply the password lock when installing a communication option, set Pr.296 ≠ "0,100". (Refer to page 199). If the problem still persists after taking the above measure, please contact your sales representative. 	

Operation panel indication	E. 1	E. 1
Name	Option fault	
Description	Stops the inverter output when excessive noise occurs around the inverter. Appears if the switch for manufacturer setting has been changed.	
Check point	<ul style="list-style-type: none"> Check for excess electrical noises around the inverter. Check the switch position for the manufacturer setting. 	
Corrective action	<ul style="list-style-type: none"> Take measures against noises if there are devices producing excess electrical noises around the inverter. Return the switch position for the manufacturer setting to the initial status. If the problem still persists after taking the above measure, please contact your sales representative. 	

Operation panel indication	E.PE	E. PE
Name	Parameter storage device fault (control circuit board)	
Description	Stops the inverter output if fault occurred in the parameter stored. (EEPROM fault)	
Check point	Check for too many number of parameter write times.	
Corrective action	Please contact your sales representative. When performing parameter write frequently for communication purposes, set "1" in Pr. 342 to enable RAM write. Note that powering OFF returns the inverter to the status before RAM write.	

Operation Panel Indication	E.PE2	E.PE2
Name	Internal board fault	
Description	When the combination of the control board and the main circuit board is wrong, the inverter is tripped.	
Check point	—	
Corrective action	Please contact your sales representative.	

Operation panel indication	E.RET	E.r-ET
Name	Retry count excess	
Description	If operation cannot be resumed properly within the number of retries set, this function trips the inverter. This function is available only when Pr. 67 Number of retries at fault occurrence is set. When the initial value (Pr. 67 = "0") is set, this protective function is not available.	
Check point	Find the cause of fault occurrence.	
Corrective action	Eliminate the cause of the error preceding this error indication.	

Operation panel indication	E. 5	E. 5
	E. 6	E. 6
	E. 7	E. 7
	E.CPU	E.CPU
Name	CPU fault	
Description	Stops the inverter output if the communication fault of the built-in CPU occurs.	
Check point	<ul style="list-style-type: none"> Check for devices producing excess electrical noises around the inverter. Check if the terminal PC is shorted with the terminal SD. (E. 6/E. 7) 	
Corrective action	<ul style="list-style-type: none"> Take measures against noises if there are devices producing excess electrical noises around the inverter. Check the connection between the terminals PC and SD. (E. 6/E. 7) Please contact your sales representative. 	

Causes and corrective actions

Operation panel indication	E.MB4 to 7	E.MB4 to E.MB7
Name	Brake sequence fault	
Description	<ul style="list-style-type: none"> The inverter output is stopped when a sequence error occurs during use of the brake sequence function (Pr. 278 to Pr. 283). This protective function is not available in the initial status. (Refer to page 160). 	
Check point	Find the cause of alarm occurrence.	
Corrective action	Check the set parameters and perform wiring properly.	

Operation panel indication	E.IOH	E.I OH
Name	Inrush current limit circuit fault	
Description	Stops the inverter output when the resistor of inrush current limit circuit overheated. The inrush current limit circuit fault	
Check point	Check that frequent power ON/OFF is not repeated.	
Corrective action	Configure a circuit where frequent power ON/OFF is not repeated. If the problem still persists after taking the above measure, please contact your sales representative.	

Operation panel indication	E.USB	E.USB
Name	USB communication fault	
Description	When communication has broken during the time set in Pr. 548 USB communication check time interval, this function stops the inverter output.	
Check point	<ul style="list-style-type: none"> Check the USB communication cable. 	
Corrective action	<ul style="list-style-type: none"> Check the Pr. 548 USB communication check time interval setting. Check the USB communication cable. Increase the Pr. 548 USB communication check time interval setting. Or, change the setting to 9999. (Refer to page 220). 	

Operation panel indication	E.SAF	E.SAF
Name	Safety circuit fault	
Description	Appears when safety circuit is malfunctioning. Appears when one of the lines between S1 and PC, or between S2 and PC is opened. The indication may appear when the start-up time of the 24V power supply is too long in the 24V external power supply operation.	
Check point	<ul style="list-style-type: none"> If the indication appears when safety stop function is not used, check if shorting wires between S1 and PC, S2 and PC are connected. If the indication appears when safety stop function is used, check that the safety relay module or the connection has no fault. Check if the start up of the 24V external power supply is taking 500ms or longer. 	
Corrective action	<ul style="list-style-type: none"> When not using the safety stop function, short across terminals S1 and PC and across S2 and PC with shorting wire. (Refer to page 24). When using the safety stop function, check that wiring of terminal S1, S2 and PC is correct and the safety stop input signal source such as safety relay module is operating properly. Refer to the Safety stop function instruction manual (BCN-211508-004) for causes and countermeasures. (Refer to the front cover of the Instruction Manual (Basic) for how to obtain the manual.) Set the start-up time of the 24V external power supply to be within 500ms. 	

Operation panel indication	E.13	E. 13
Name	Internal circuit fault	
Description	Stop the inverter output when an internal circuit fault occurred.	
Corrective action	Please contact your sales representative.	



NOTE

- If faults other than the above appear, contact your sales representative.

6.4 Correspondences between digital and actual characters

There are the following correspondences between the actual alphanumeric characters and the digital characters displayed on the operation panel:

Actual	Digital
0	0
1	1
2	2
3	3
4	4
5	5
6	6
7	7
8	8
9	9

Actual	Digital
A	A
B	b
C	C
D	d
E	E
F	F
G	G
H	H
I	I
J	J
L	L

Actual	Digital
M	m
N	n
O	O
o	o
P	P
S	S
T	T
U	U
V	V
r	r
-	-



6.5 Check first when you have a trouble



POINT

- If the cause is still unknown after every check, it is recommended to initialize the parameters (initial value) then set the required parameter values and check again.

6.5.1 Motor does not start

Check points	Possible Cause	Countermeasures	Refer to page
Main circuit	Appropriate power supply voltage is not applied. (Operation panel display is not provided during operation with main circuit power supply.)	Power ON a moulded case circuit breaker (MCCB), an earth leakage circuit breaker (ELB), or a magnetic contactor (MC). Check for the decreased input voltage, input phase loss, and wiring.	—
	Motor is not connected properly.	Check the wiring between the inverter and the motor.	15
	The jumper across P/+ and P1 is disconnected.	Securely fit a jumper across P/+ and P1. When using a DC reactor (FR-HEL), remove the jumper across P/+ and P1, and then connect the DC reactor.	29
Input signal	Start signal is not input.	Check the start command source, and input a start signal. PU operation mode:  Network operation mode: STF/STR signal	103
	Both the forward and reverse rotation start signals (STF, STR) are input simultaneously.	Turn ON only one of the forward and reverse rotation start signals (STF or STR). If STF and STR signals are turned ON simultaneously in the initial setting, a stop command is given.	20
	Frequency command is zero. (RUN LED on the operation panel is flickering.)	Check the frequency command source and enter a frequency command.	103
	Output stop signal (MRS) is ON. (RUN LED on the operation panel flickers while MRS signal is ON.)	Turn MRS signal OFF. Inverter starts the operation with a given start command and a frequency command after turning OFF MRS signal. Before turning OFF, ensure the safety.	166
	The shorting wires across S1 and PC and across S2 and PC are removed although the safety stop function is not being used.	When not using the safety stop function, short across terminals S1 and PC and across S2 and PC with shorting wires.	24
	 was pressed. (Operation panel indication is <i>PS</i> (PS).)	During the Network operation mode, check the method of restarting from a  input stop from the operation panel.	235
Parameter setting	<i>Pr. 0 Torque boost</i> setting is improper when V/F control is used.	Increase <i>Pr. 0</i> setting by 0.5% increments while observing the rotation of a motor. If that makes no difference, decrease the setting.	113
	<i>Pr. 78 Reverse rotation prevention selection</i> is set.	Check the <i>Pr. 78</i> setting. Set <i>Pr. 78</i> when you want to limit the motor rotation to only one direction.	197
	<i>Pr. 13 Starting frequency</i> setting is greater than the running frequency.	Set running frequency higher than <i>Pr. 13</i> . The inverter does not start if the frequency setting signal is less than the value set in <i>Pr. 13</i> .	138
	Frequency settings of various running frequency (such as multi-speed operation) are zero. Especially, <i>Pr. 1 Maximum frequency</i> is zero.	Set the frequency command according to the application. Set <i>Pr. 1</i> higher than the actual frequency used.	124
	<i>Pr. 15 Jog frequency</i> setting is lower than <i>Pr. 13 Starting frequency</i> .	Set <i>Pr. 15 Jog frequency</i> higher than <i>Pr. 13 Starting frequency</i> .	201

Check points	Possible Cause	Countermeasures	Refer to page
Parameter setting	Inverter decelerated to a stop when power failure deceleration stop function is selected.	When power is restored, ensure the safety, and turn OFF the start signal once, then turn ON again to restart. Inverter restarts when Pr. 261="2".	186
	Performing auto tuning.	When offline auto tuning ends, press  on the operation panel for the PU operation. For the Network operation, turn OFF the start signal (STF or STR). This operation resets the offline auto tuning, and the operation panel monitor display returns to the normal indication. (Without this operation, next operation cannot be started.)	146
	Automatic restart after instantaneous power failure function or power failure stop function is activated. (Performing overload operation with single-phase power input model may cause voltage insufficiency, and results in a detection of power failure.)	<ul style="list-style-type: none"> • Disable the automatic restart after instantaneous power failure function and power failure stop function. • Reduce the load. • Increase the acceleration time if the automatic restart after instantaneous power failure function or power failure stop function occurred during acceleration. 	180, 186
Load	Load is too heavy.	Reduce the load.	—
	Shaft is locked.	Inspect the machine (motor).	—
Others	The program, which starts inverter operation, has not been designed correctly.	Design the program correctly.	67
	The program, which starts inverter operation, has not been executed correctly.	Execute the program correctly.	67
	Operation panel display shows an error (e.g. E.OC1).	When any fault occurs, take an appropriate corrective action, then reset the inverter, and resume the operation.	233

6.5.2 Motor or machine is making abnormal acoustic noise

Check points	Possible Cause	Countermeasures	Refer to page
Parameter setting	No carrier frequency noises (metallic noises) are generated.	In the initial setting, <i>Pr. 240 Soft-PWM operation selection</i> is enabled to change motor noise to an unoffending complex tone. Therefore, no carrier frequency noises (metallic noises) are generated. Set <i>Pr. 240 = "0"</i> to disable this function.	192
	Resonance occurs. (output frequency)	Set <i>Pr. 31 to Pr. 36 (Frequency jump)</i> . When it is desired to avoid resonance attributable to the natural frequency of a mechanical system, these parameters allow resonant frequencies to be jumped.	125
	Resonance occurs. (carrier frequency)	Change <i>Pr. 72 PWM frequency selection</i> setting. Changing the PWM carrier frequency produces an effect on avoiding the resonance frequency of a mechanical system or a motor.	192
	Auto tuning is not performed under Advanced magnetic flux vector control or General-purpose magnetic flux vector control.	Perform offline auto tuning.	146
	Gain adjustment during PID control is insufficient.	To stabilize the measured value, change the proportional band (<i>Pr. 129</i>) to a larger value, the integral time (<i>Pr. 130</i>) to a slightly longer time, and the differential time (<i>Pr. 134</i>) to a slightly shorter time. Check the calibration of set point and measured value.	203
Others	Mechanical looseness	Adjust machine/equipment so that there is no mechanical looseness.	—
Motor	Operating with output phase loss	Check the motor wiring.	—
	Contact the motor manufacturer.		

6.5.3 Inverter generates abnormal noise

Check points	Possible Cause	Countermeasures	Refer to page
Fan	Fan cover was not correctly installed when a cooling fan was replaced.	Install a fan cover correctly.	257

6.5.4 Motor generates heat abnormally

Check points	Possible Cause	Countermeasures	Refer to page
Motor	Motor fan is not working (Dust is accumulated.)	Clean the motor fan. Improve the environment.	—
	Phase to phase insulation of the motor is insufficient.	Check the insulation of the motor.	—
Main circuit	The inverter output voltage (U, V, W) are unbalanced.	Check the output voltage of the inverter. Check the insulation of the motor.	253
Parameter setting	The <i>Pr. 71 Applied motor</i> setting is wrong.	Check the <i>Pr. 71 Applied motor</i> setting.	144
—	Motor current is large.	Refer to "6.5.11 Motor current is too large"	249

6.5.5 Motor rotates in the opposite direction

Check points	Possible Cause	Countermeasures	Refer to page
Main circuit	Phase sequence of output terminals U, V and W is incorrect.	Connect phase sequence of the output cables (terminal U, V, W) to the motor correctly	15
Parameter setting	Frequency command with sign (<i>Pr. 541</i> = "1") is selected for CC-Link communication.	Check the <i>Pr. 541 Frequency command sign selection (CC-Link)</i> setting.	105
	<i>Pr. 40 RUN key rotation direction selection</i> setting is incorrect.	Check the <i>Pr. 40</i> setting.	223

6.5.6 Speed greatly differs from the setting

Check points	Possible Cause	Countermeasures	Refer to page
Parameter setting	<i>Pr. 1, Pr. 2, Pr. 18</i> settings are improper.	Check the settings of <i>Pr. 1 Maximum frequency, Pr. 2 Minimum frequency, Pr. 18 High speed maximum frequency.</i>	124
	<i>Pr. 31 to Pr. 36 (frequency jump)</i> settings are improper.	Narrow down the range of frequency jump.	125
Load	Stall prevention function is activated due to a heavy load.	Reduce the load weight.	—
Parameter setting		Set <i>Pr. 22 Stall prevention operation level</i> higher according to the load. (Setting <i>Pr. 22</i> too large may result in frequent overcurrent trip (E.OCC).)	120
Motor		Check the capacities of the inverter and the motor.	—

6.5.7 Acceleration/deceleration is not smooth

Check points	Possible Cause	Countermeasures	Refer to page
Parameter setting	The base frequency does not match the motor characteristics.	For V/F control, set <i>Pr. 3 Base frequency</i> and <i>Pr. 47 Second V/F (base frequency)</i> .	126
		For Advanced magnetic flux vector control or General-purpose magnetic flux vector control, set <i>Pr. 84 Rated motor frequency</i> .	146
	Stall prevention function is activated due to a heavy load.	Reduce the load weight.	—
		Set <i>Pr. 22 Stall prevention operation level</i> higher according to the load. (Setting <i>Pr. 22</i> too large may result in frequent overcurrent trip (E.OCC).)	120
		Check the capacities of the inverter and the motor.	—
	Acceleration/deceleration time is too short.	Increase acceleration/deceleration time.	135
	Torque boost (<i>Pr. 0, Pr. 46</i>) setting is improper under V/F control, so the stall prevention function is activated.	Increase/decrease <i>Pr. 0 Torque boost</i> setting value by 0.5% increments to the setting.	113
Regeneration avoidance operation is performed	If the frequency becomes unstable during regeneration avoidance operation, decrease the setting of <i>Pr. 886 Regeneration avoidance voltage gain</i> .	211	

6.5.8 Speed varies during operation



When Advanced magnetic flux vector control or the slip compensation is selected, the output frequency varies between 0 and 2Hz as load fluctuates. This is a normal operation and not a fault.

Check points	Possible Cause	Countermeasures	Refer to page
Load	Load varies during an operation.	Select Advanced magnetic flux vector control or General-purpose magnetic flux vector control.	114
Input signal	Frequency setting signal is varying.	Check the frequency setting signal.	—
Parameter setting	Pr. 80 Motor capacity and Pr. 81 Number of motor poles settings are improper for the capacities of the inverter and the motor for Advanced magnetic flux vector control or General-purpose magnetic flux vector control.	Check the Pr. 80 Motor capacity and Pr. 81 Number of motor poles settings.	114
	Fluctuation of power supply voltage is too large.	Change the Pr. 19 Base frequency voltage setting (about 3%) under V/F control.	126
	Hunting occurs by the generated vibration, for example, when structural rigidity at load side is insufficient.	Disable automatic control functions, such as energy saving operation, fast-response current limit function, regeneration avoidance function, Advanced magnetic flux vector control, General-purpose magnetic flux vector control, and stall prevention. During the PID control, set smaller values to Pr.129 PID proportional band and Pr.130 PID integral time. Lower the control gain, and adjust to increase the stability. Change Pr. 72 PWM frequency selection setting.	— 192
Others	Wiring length exceeds 30m when Advanced magnetic flux vector control or General-purpose magnetic flux vector control is performed.	Perform offline auto tuning.	146
	Wiring length is too long for V/F control, and a voltage drop occurs.	Adjust Pr. 0 Torque boost by increasing with 0.5% increments for low-speed operation.	113
		Change to Advanced magnetic flux vector control or General-purpose magnetic flux vector control.	114

6.5.9 Operation mode is not changed properly

Check points	Possible Cause	Countermeasures	Refer to page
Input signal	Start signal (STF or STR) is ON.	Check that the STF and STR signals are OFF. When either is ON, the operation mode cannot be changed.	103
Parameter setting	Pr. 79 setting is improper.	When Pr. 79 Operation mode selection setting is "0" (initial value), the inverter is placed in the Network operation mode at input power ON. To switch to the PU operation mode, press  on the operation panel. Switchover mode is selected with the setting value "6".	103
	Pr. 542 Communication station number (CC-Link) is set incorrectly. (Unmatched with the program, overlapping station number, out-of-range station number, etc.)	Set Pr. 542 Communication station number (CC-Link) correctly.	105
Others	The CC-Link dedicated cable is not installed correctly. (having contact faults and breaks, etc.)	Install the CC-Link dedicated cable correctly.	52
	The operation mode switching program is not designed correctly.	Design the operation mode switching program correctly.	69
	The operation mode switching program has not been executed.	Execute the operation mode switching program.	69

6.5.10 Operation panel display is not operating

Check points	Possible Cause	Countermeasures	Refer to page
Main circuit	Wiring or installation is improper.	Check for the wiring and the installation.	14
		Make sure that the connector is fitted securely across terminals P/+ and P1.	
Main circuit control circuit	Power is not input.	Input the power.	14
Parameter setting	Command sources at the PU operation mode is not at the operation panel. (None of the operation mode indicators (  ) is lit.)	Check the setting of Pr. 551 PU mode operation command source selection.	220

6.5.11 Motor current is too large

Check points	Possible Cause	Countermeasures	Refer to page
Parameter setting	Torque boost (Pr. 0, Pr. 46) setting is improper under V/F control, so the stall prevention function is activated.	Increase/decrease Pr. 0 Torque boost setting value by 0.5% increments to the setting.	113
	V/F pattern is improper when V/F control is performed. (Pr. 3, Pr. 14, Pr. 19)	Set rated frequency of the motor to Pr. 3 Base frequency. Use Pr. 19 Base frequency voltage to set the base voltage (e.g. rated motor voltage).	126
		Change Pr. 14 Load pattern selection according to the load characteristic.	128
	Stall prevention function is activated due to a heavy load.	Reduce the load weight.	—
		Set Pr. 22 Stall prevention operation level higher according to the load. (Setting Pr. 22 too large may result in frequent overcurrent trip (E.OC□).)	120
		Check the capacities of the inverter and the motor.	—
Auto tuning is not performed under Advanced magnetic flux vector control or General-purpose magnetic flux vector control.	Perform offline auto tuning.	146	

6.5.12 Speed does not accelerate

Check points	Possible Cause	Countermeasures	Refer to page
Parameter setting	Pr. 1, Pr. 2, Pr. 18 settings are improper.	Check the settings of Pr. 1 Maximum frequency and Pr. 2 Minimum frequency. If you want to run the motor at 120Hz or higher, set Pr. 18 High speed maximum frequency.	124
	Torque boost (Pr. 0, Pr. 46) setting is improper under V/F control, so the stall prevention function is activated.	Increase/decrease Pr. 0 Torque boost setting value by 0.5% increments so that stall prevention does not occur.	113
	V/F pattern is improper when V/F control is performed. (Pr. 3, Pr. 14, Pr. 19)	Set rated frequency of the motor to Pr. 3 Base frequency. Use Pr. 19 Base frequency voltage to set the base voltage (e.g. rated motor voltage).	126
		Change Pr. 14 Load pattern selection according to the load characteristic.	128
	Stall prevention function is activated due to a heavy load.	Reduce the load weight.	—
		Set Pr. 22 Stall prevention operation level higher according to the load. (Setting Pr. 22 too large may result in frequent overcurrent trip (E.OC□).)	120
		Check the capacities of the inverter and the motor.	—
Auto tuning is not performed under Advanced magnetic flux vector control or General-purpose magnetic flux vector control.	Perform offline auto tuning.	146	
During PID control, output frequency is automatically controlled to make measured value = set point.		203	
Main circuit	Brake resistor is connected between terminal P/+ and P1 or between terminal P1 and PR by mistake.	Connect an optional brake transistor (MRS type, MYS type, FR-ABR) between terminal P/+ and PR.	26

6.5.13 Unable to write parameter setting

Check points	Possible Cause	Countermeasures	Refer to page
Input signal	Operation is being performed (signal STF or STR is ON).	Stop the operation. When Pr. 77 = "0" (initial value), write is enabled only during a stop.	196
Parameter setting	You are attempting to set the parameter in the Network operation mode.	Choose the PU operation mode. Or, set Pr. 77 = "2" to enable parameter write regardless of the operation mode.	196
	Parameter is disabled by the Pr. 77 Parameter write selection setting.	Check Pr. 77 Parameter write selection setting.	196
	Key lock is activated by the Pr. 161 Frequency setting/key lock operation selection setting.	Check Pr. 161 Frequency setting/key lock operation selection setting.	224

7 PRECAUTIONS FOR MAINTENANCE AND INSPECTION

This chapter provides the "PRECAUTIONS FOR MAINTENANCE AND INSPECTION" of this product.
Always read the instructions before using the equipment.

7.1	Inspection items.....	252
7.2	Measurement of main circuit voltages, currents and powers ..	259

1

2

3

4

5

6

7

8

The inverter is a static unit mainly consisting of semiconductor devices. Daily inspection must be performed to prevent any fault from occurring due to the adverse effects of the operating environment, such as temperature, humidity, dust, dirt and vibration, changes in the parts with time, service life, and other factors.

●Precautions for maintenance and inspection

For some short time after the power is switched OFF, a high voltage remains in the smoothing capacitor. When accessing the inverter for inspection, wait for at least 10 minutes after the power supply has been switched OFF, and then make sure that the voltage across the main circuit terminals P/+ and N/- of the inverter is not more than 30VDC using a tester, etc.

If "EV" is displayed on the operation panel, turn off the 24V external power supply before an inspection.

7.1 Inspection items

7.1.1 Daily inspection

Basically, check for the following faults during operation.

- (1) Motor operation fault
- (2) Improper installation environment
- (3) Cooling system fault
- (4) Abnormal vibration, abnormal noise
- (5) Abnormal overheat, discoloration

7.1.2 Periodic inspection

Check the areas inaccessible during operation and requiring periodic inspection.

For a periodic inspection, contact your sales representative.

- (1) Check for cooling system fault.....Clean the air filter, etc.
- (2) Tightening check and retightening.....The screws and bolts may become loose due to vibration, temperature changes, etc. Check and tighten them.
Tighten them according to the specified tightening torque (*Refer to page 17*).
- (3) Check the conductors and insulating materials for corrosion and damage.
- (4) Measure insulation resistance.
- (5) Check and change the cooling fan and relay.

When using the safety stop function, periodic inspection is required to confirm that safety function of the safety system operates correctly.

For more details, refer to the Safety stop function instruction manual (BCN-A211508-004). (Refer to the front cover of the Instruction Manual (Basic) for how to obtain the manual.)

7.1.3 Daily and periodic inspection

Area of Inspection	Inspection Item	Description	Interval		Corrective Action at Alarm Occurrence	Customer's Check	
			Daily	Periodic *2			
General	Surrounding environment	Check the surrounding air temperature, humidity, dirt, corrosive gas, oil mist, etc.	○		Improve environment		
	Overall unit	Check for unusual vibration and noise.	○		Check alarm location and retighten		
	Power supply voltage	Check that the main circuit voltages are normal.*1	○		Inspect the power supply		
Main circuit	General	(1) Check with megger (across main circuit terminals and earth (ground) terminal). (2) Check for loose screws and bolts. (3) Check for overheat traces on the parts. (4) Check for stain.		○ ○ ○ ○	Contact the manufacturer Retighten Contact the manufacturer Clean		
	Conductors, cables	(1) Check conductors for distortion. (2) Check cable sheaths for breakage and deterioration (crack, discoloration, etc.).		○ ○	Contact the manufacturer Contact the manufacturer		
	Terminal block	Check for damage.		○	Stop the device and contact the manufacturer.		
	Smoothing aluminum electrolytic capacitor	(1) Check for liquid leakage. (2) Check for safety valve projection and bulge. (3) Visual check and judge by the life check of the main circuit capacitor. (Refer to page 254)		○ ○ ○	Contact the manufacturer Contact the manufacturer		
	Relay	Check that the operation is normal and no chatter is heard.		○	Contact the manufacturer		
Control circuit, Protective circuit	Operation check	(1) Check that the output voltages across phases with the inverter operated alone is balanced. (2) Check that no fault is found in protective and display circuits in a sequence protective operation test.		○ ○	Contact the manufacturer Contact the manufacturer		
	Parts check	Overall	(1) Check for unusual odor and discoloration. (2) Check for serious rust development.		○ ○	Stop the device and contact the manufacturer. Contact the manufacturer	
		Aluminum electrolytic capacitor	(1) Check for liquid leakage in a capacitor and deformation trace. (2) Visual check and judge by the life check of the main circuit capacitor. (Refer to page 254)		○ ○	Contact the manufacturer	
Cooling system	Cooling fan	(1) Check for unusual vibration and noise. (2) Check for loose screws and bolts. (3) Check for stain.	○	○ ○ ○	Replace the fan Fix with the fan cover fixing screws Clean		
	Heatsink	(1) Check for clogging. (2) Check for stain.		○ ○	Clean Clean		
Display	Indication	(1) Check that display is normal. (2) Check for stain.	○	○	Contact the manufacturer Clean		
	Meter	Check that reading is normal.	○		Stop the device and contact the manufacturer.		
Load motor	Operation check	Check for vibration and abnormal increase in operation noise.	○		Stop the device and contact the manufacturer.		

*1 It is recommended to install a device to monitor voltage for checking the power supply voltage to the inverter.

*2 One to two years of periodic inspection cycle is recommended. However, it differs according to the installation environment. For a periodic inspection, contact your sales representative.

7.1.4 Display of the life of the inverter parts

The self-diagnostic alarm is output when the life span of the control circuit capacitor, cooling fan and each parts of the inrush current limit circuit is near its end. It gives an indication of replacement time.

The life alarm output can be used as a guideline for life judgement.

Parts	Judgement Level
Main circuit capacitor	85% of the initial capacity
Control circuit capacitor	Estimated remaining life 10%
Inrush current limit circuit	Estimated remaining life 10% (Power ON: 100,000 times left)
Cooling fan	Less than 50% of the predetermined speed



POINT

Refer to page 214 to perform the life check of the inverter parts.

7.1.5 Checking the inverter and converter modules

<Preparation>

- (1) Disconnect the external power supply cables (R/L1, S/L2, T/L3) and motor cables (U, V, W).
- (2) Prepare a tester. (Use 100Ω range.)

<Checking method>

Change the polarity of the tester alternately at the inverter terminals R/L1, S/L2, T/L3, U, V, W, P/+ and N/-, and check for electric continuity.



NOTE

1. Before measurement, check that the smoothing capacitor is discharged.
2. At the time of electric discontinuity, the measured value is almost ∞ . When there is an instantaneous electric continuity, due to the smoothing capacitor, the tester may not indicate ∞ . At the time of continuity, the measured value is several to several tens-of ohms depending on the module type, circuit tester type, etc. If all measured values are almost the same, the modules are without fault.

<Module device numbers and terminals to be checked>

	Tester Polarity		Measured Value	Tester Polarity		Measured Value
	+	-		+	-	
Converter module	D1	R/L1 P/+	Discontinuity	D4	R/L1 N/-	Continuity
		P/+ R/L1	Continuity		N/- R/L1	Discontinuity
	D2	S/L2 P/+	Discontinuity	D5	S/L2 N/-	Continuity
		P/+ S/L2	Continuity		N/- S/L2	Discontinuity
	D3*	T/L3* P/+	Discontinuity	D6*	T/L3* N/-	Continuity
		P/+ T/L3*	Continuity		N/- T/L3*	Discontinuity
Inverter module	TR1	U P/+	Discontinuity	TR4	U N/-	Continuity
		P/+ U	Continuity		N/- U	Discontinuity
	TR3	V P/+	Discontinuity	TR6	V N/-	Continuity
		P/+ V	Continuity		N/- V	Discontinuity
	TR5	W P/+	Discontinuity	TR2	W N/-	Continuity
		P/+ W	Continuity		N/- W	Discontinuity

(Assumes the use of an analog meter.)

* T/L3, D3 and D6 are only for the three-phase power input models.

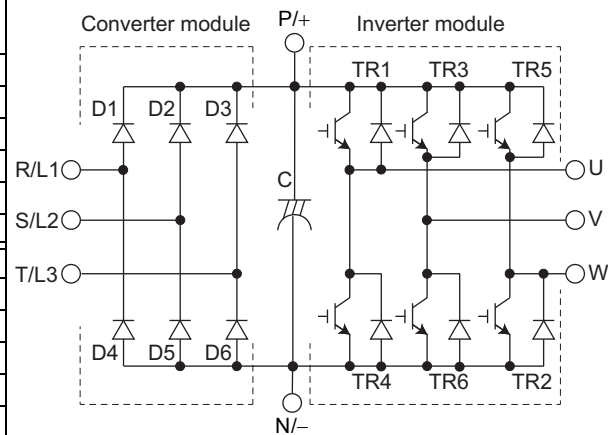

7.1.6 Cleaning

Always run the inverter in a clean status.

When cleaning the inverter, gently wipe dirty areas with a soft cloth immersed in neutral detergent or ethanol.



NOTE

Do not use solvent, such as acetone, benzene, toluene and alcohol, as they will cause the inverter surface paint to peel off. The display, etc. of the operation panel are vulnerable to detergent and alcohol. Therefore, avoid using them for cleaning.

7.1.7 Replacement of parts

The inverter consists of many electronic parts such as semiconductor devices.

The following parts may deteriorate with age because of their structures or physical characteristics, leading to reduced performance or fault of the inverter. For preventive maintenance, the parts must be replaced periodically.

Use the life check function as a guidance of parts replacement.

Part Name	Estimated Lifespan	Description
Cooling fan	10 years	Replace (as required)
Main circuit smoothing capacitor	10 years *2	Replace (as required)
On-board smoothing capacitor	10 years *2	Replace the board (as required)
Relays	—	as required

*1 Estimated lifespan for when the yearly average surrounding air temperature is 40°C (without corrosive gas, flammable gas, oil mist, dust and dirt etc.)

*2 Output current: 80% of the inverter rated current



NOTE

For parts replacement, consult the nearest Mitsubishi FA Center.

(1) Cooling fan

The replacement interval of the cooling fan used for cooling the parts generating heat such as the main circuit semiconductor is greatly affected by the surrounding air temperature. When unusual noise and/or vibration is noticed during inspection, the cooling fan must be replaced immediately.

●Removal

- 1) Push the hooks from above and remove the fan cover.

3.7K or lower

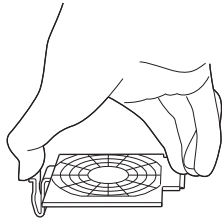

5.5K or higher

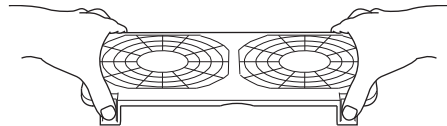

- 2) Disconnect the fan connectors.

- 3) Remove the fan.

3.7K or lower

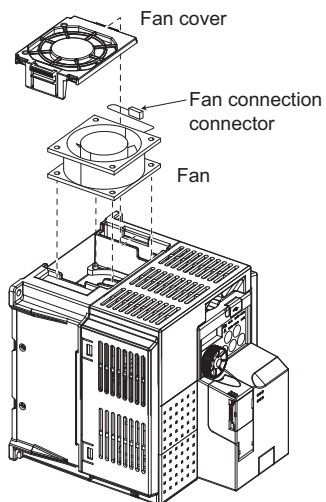

Example for FR-E740-3.7KNC

5.5K or higher

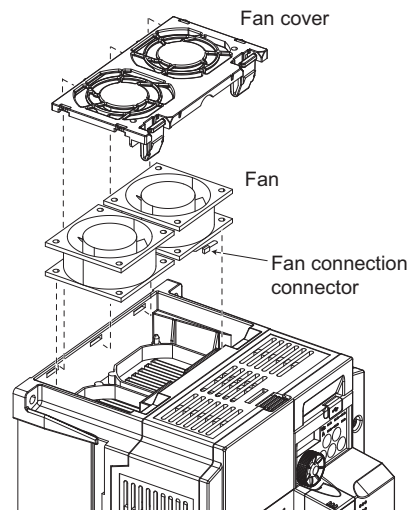

Example for FR-E720-5.5KNC

●Reinstallation

- 1) After confirming the orientation of the fan, reinstall the fan so that the arrow on the left of "AIR FLOW" faces up.

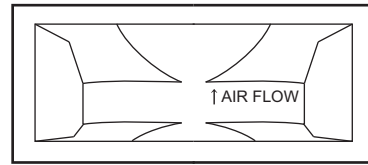

<Fan side face>

- 2) Reconnect the fan connectors.
- 3) When wiring, avoid the cables being caught by the fan.

3.7K or lower

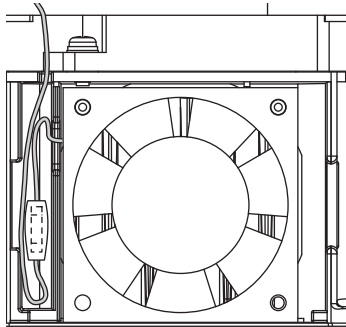

5.5K or higher

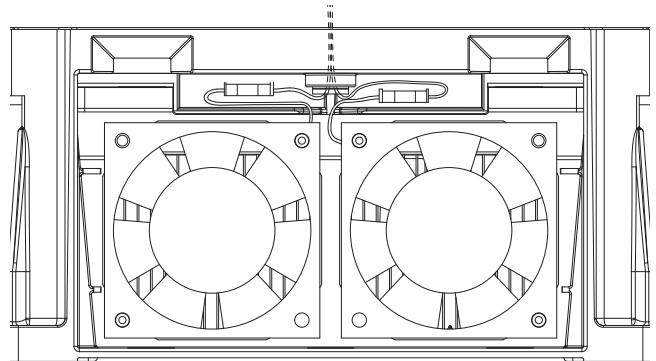

- 4) Reinstall the fan cover.

3.7K or lower

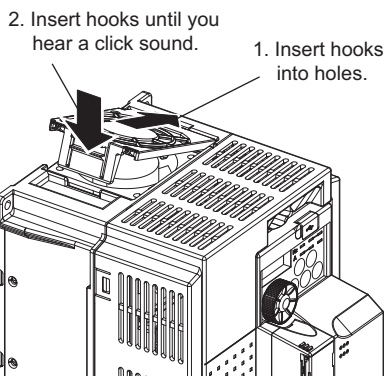

Example for FR-E740-3.7KNC

5.5K or higher

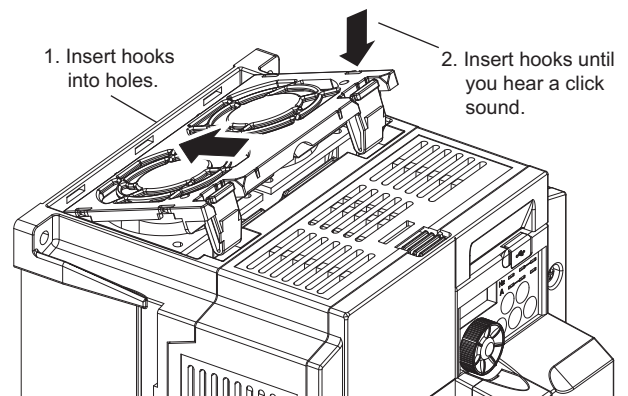

Example for FR-E720-5.5KNC



NOTE

- Installing the fan in the opposite of air flow direction can cause the inverter life to be shorter.
- Prevent the cable from being caught when installing a fan.
- Switch the power OFF before replacing fans. Since the inverter circuits are charged with voltage even after power OFF, replace fans only when the inverter cover is on the inverter to prevent an electric shock accident.

(2) Smoothing capacitors

A large-capacity aluminum electrolytic capacitor is used for smoothing in the main circuit DC section, and an aluminum electrolytic capacitor is used for stabilizing the control power in the control circuit. Their characteristics are deteriorated by the adverse effects of ripple currents, etc. The replacement intervals greatly vary with the surrounding air temperature and operating conditions. When the inverter is operated in air-conditioned, normal environment conditions, replace the capacitors about every 10 years.

When a certain period of time has elapsed, the capacitors will deteriorate more rapidly. Check the capacitors at least every year (less than six months if the life will be expired soon).

The appearance criteria for inspection are as follows:

- 1) Case: Check the side and bottom faces for expansion
- 2) Sealing plate: Check for remarkable warp and extreme crack.
- 3) Check for external crack, discoloration, liquid leakage, etc. Judge that the capacitor has reached its life when the measured capacitance of the capacitor reduced below 80% of the rating.



POINT

Refer to page 214 to perform the life check of the main circuit capacitor.

(3) Relays

To prevent a contact fault, etc., relays must be replaced according to the cumulative number of switching times (switching life).

7.2 Measurement of main circuit voltages, currents and powers

Since the voltages and currents on the inverter power supply and output sides include harmonics, measurement data depends on the instruments used and circuits measured.

When instruments for commercial frequency are used for measurement, measure the following circuits with the instruments given on the next page.

- When installing meters etc. on the inverter output side

When the inverter-to-motor wiring length is large, especially in the 400V class, small-capacity models, the meters and CTs may generate heat due to line-to-line leakage current. Therefore, choose the equipment which has enough allowance for the current rating.

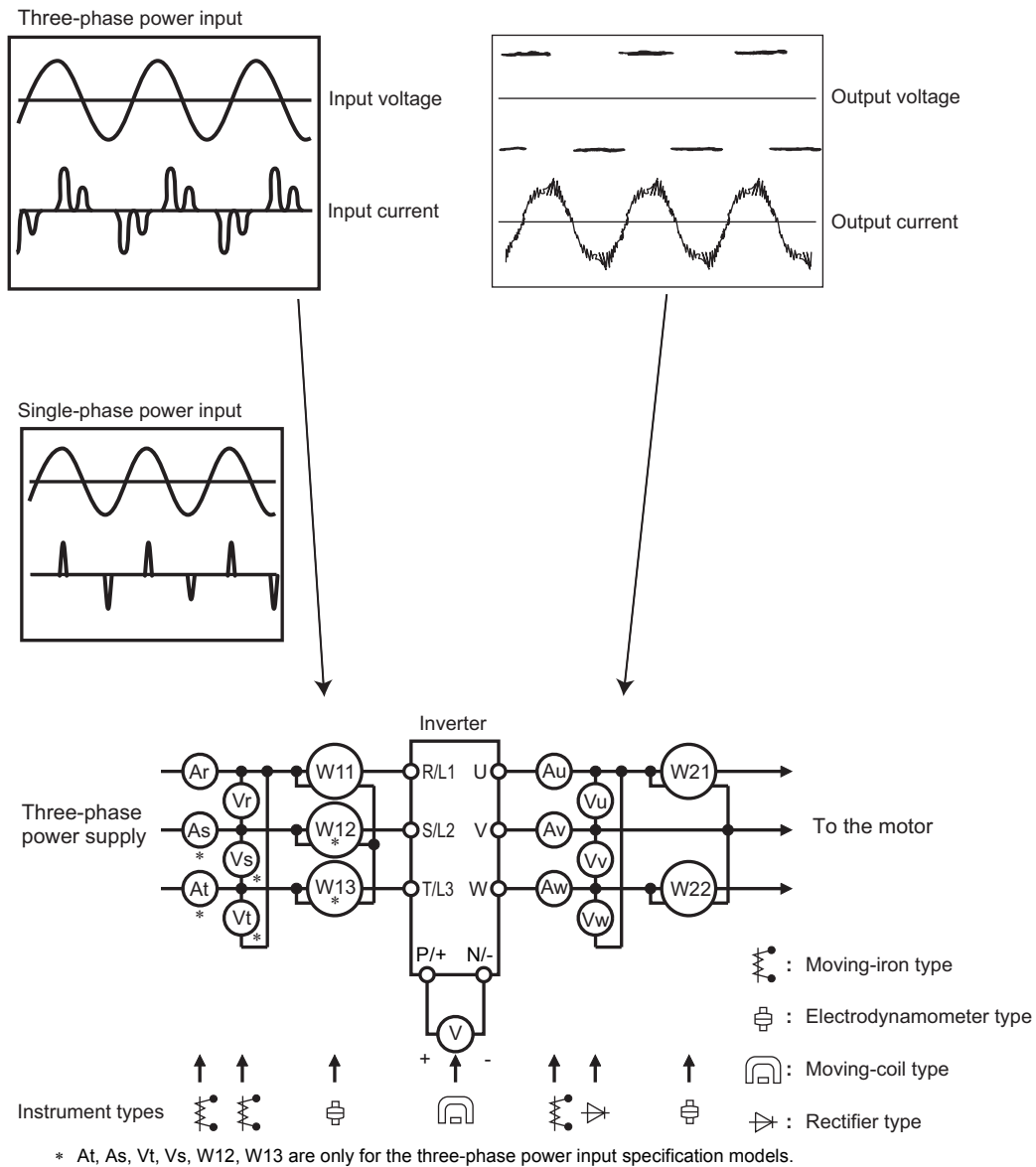

Examples of Measuring Points and Instruments

Measuring Points and Instruments

Item	Measuring Point	Measuring Instrument	Remarks (Reference Measured Value)
Power supply voltage V ₁	R/L1 and S/L2 S/L2 and T/L3 T/L3 and R/L1 *3	Moving-iron type AC voltmeter *4	Commercial power supply Within permissible AC voltage fluctuation (<i>Refer to page 266</i>)
Power supply side current I ₁	R/L1, S/L2, T/L3 line current *3	Moving-iron type AC ammeter *4	
Power supply side power P ₁	R/L1, S/L2, T/L3 and R/L1 and S/L2, S/L2 and T/L3, T/L3 and R/L1 *3	Digital power meter (designed for inverter) or electrodynamic type single- phase wattmeter	P ₁ =W ₁₁ +W ₁₂ +W ₁₃ (3-wattmeter method)
Power supply side power factor P _{f1}	Calculate after measuring power supply voltage, power supply side current and power supply side power. [Three-phase power supply] [Single-phase power supply]		
	$P_{f1} = \frac{P_1}{\sqrt{3}V_1 \times I_1} \times 100 \%$		$P_{f1} = \frac{P_1}{V_1 \times I_1} \times 100 \%$
Output side voltage V ₂	Across U and V, V and W, W and U	Rectifier type AC voltage meter *1, *4 (moving-iron type cannot measure)	Difference between the phases is within 1% of the maximum output voltage.
Output side current I ₂	U, V and W line currents	Moving-iron type AC ammeter *2, *4	Difference between the phases is 10% or lower of the rated inverter current.
Output side power P ₂	U, V, W and U and V, V and W	Digital power meter (designed for inverter) or electrodynamic type single- phase wattmeter	P ₂ = W ₂₁ + W ₂₂ 2-wattmeter method (or 3-wattmeter method)
Output side power factor P _{f2}	Calculate in similar manner to power supply side power factor.		
	$P_{f2} = \frac{P_2}{\sqrt{3}V_2 \times I_2} \times 100 \%$		
Converter output	Across P/+ and N/-	Moving-coil type (such as tester)	Inverter LED display is lit. 1.35 × V ₁ 380V maximum during regeneration for 200V class 760V maximum during regeneration for 400V class

*1 Use an FFT to measure the output voltage accurately. An FA tester or general measuring instrument cannot measure accurately.

*2 When the carrier frequency exceeds 5kHz, do not use this instrument since using it may increase eddy-current losses produced in metal parts inside the instrument, leading to burnout. In this case, use an approximate-effective value type.

*3 T/L3 is only for the three-phase power input models.

*4 A digital power meter (designed for inverter) can also be used to measure.

7.2.1 Measurement of powers

Use electro-dynamometer type meters (for inverter) for the both of inverter input and output side. Alternatively, measure using electrodynamic type single-phase wattmeters for the both of inverter input and output side in two-wattmeter or three-wattmeter method. As the current is liable to be imbalanced especially in the input side, it is recommended to use the three-wattmeter method.

Examples of process value differences produced by different measuring meters are shown below.

An error will be produced by difference between measuring instruments, e.g. power calculation type and two- or three-wattmeter type three-phase wattmeter. When a CT is used in the current measuring side or when the meter contains a PT on the voltage measurement side, an error will also be produced due to the frequency characteristics of the CT and PT.

[Measurement conditions]

Constant-torque (100%) load, note that 60Hz or more should be constantly output 3.7kW, 4-pole motor, value indicated in 3-wattmeter method is 100%.

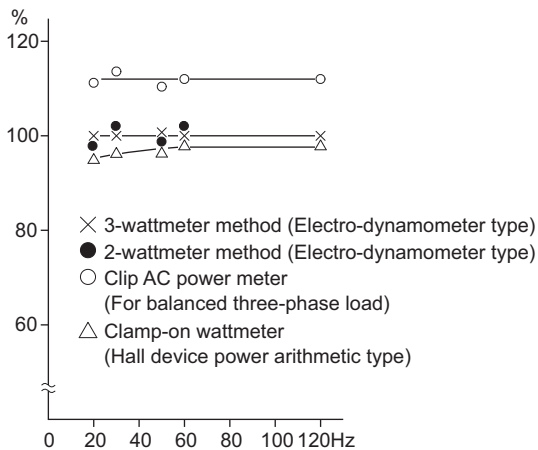

Example of Measuring Inverter Input Power

[Measurement conditions]

Constant-torque (100%) load, note that 60Hz or more should be constantly output 3.7kW, 4-pole motor, value indicated in 3-wattmeter method is 100%.

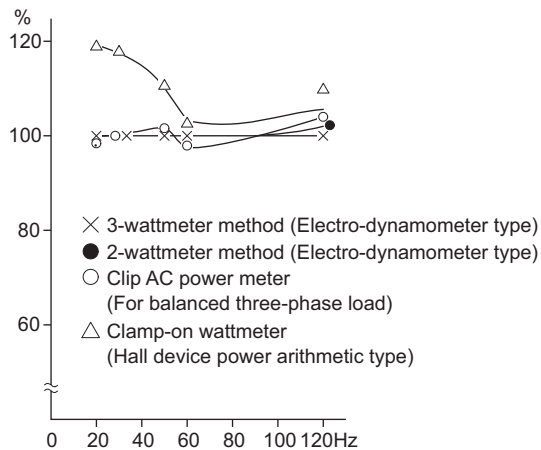

Example of Measuring Inverter Output Power

7.2.2 Measurement of voltages and use of PT

(1) Inverter input side

As the input side voltage has a sine wave and it is extremely small in distortion, accurate measurement can be made with an ordinary AC meter.

(2) Inverter output side

Since the output side voltage has a PWM-controlled rectangular wave, always use a rectifier type voltmeter. A needle type tester can not be used to measure the output side voltage as it indicates a value much greater than the actual value. A moving-iron type meter indicates an effective value which includes harmonics and therefore the value is larger than that of the fundamental wave. The value monitored on the operation panel is the inverter-controlled voltage itself. Hence, that value is accurate and it is recommended to monitor values using the operation panel.

(3) PT

No PT can be used in the output side of the inverter. Use a direct-reading meter. (A PT can be used in the input side of the inverter.)

7.2.3 Measurement of currents

Use a moving-iron type meter on both the input and output sides of the inverter. However, if the carrier frequency exceeds 5kHz, do not use that meter since an overcurrent losses produced in the internal metal parts of the meter will increase and the meter may burn out. In this case, use an approximate-effective value type.

Since current on the inverter input side tends to be unbalanced, measurement of three phases is recommended. Correct value can not be obtained by measuring only one or two phases. On the other hand, the unbalanced ratio of each phase of the output side current should be within 10%.

When a clamp ammeter is used, always use an effective value detection type. A mean value detection type produces a large error and may indicate an extremely smaller value than the actual value. The value monitored on the operation panel is accurate if the output frequency varies, and it is recommended to monitor values (provide analog output) using the operation panel.

Examples of process value differences produced by different measuring meters are shown below.

[Measurement conditions]

Value indicated by moving-iron type ammeter is 100%.

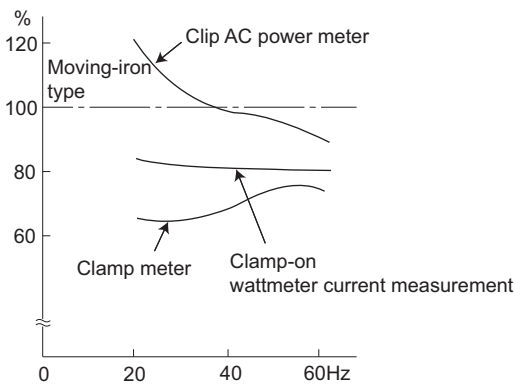

Example of measuring inverter input current

[Measurement conditions]

Value indicated by moving-iron type ammeter is 100%.

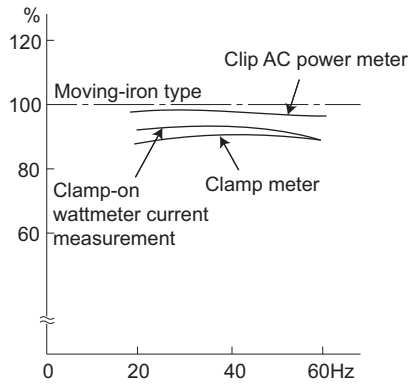

Example of measuring inverter output current

7.2.4 Use of CT and transducer

A CT may be used in both the input and output sides of the inverter, but the one used should have the largest possible VA ability because an error will increase if the frequency gets lower.

When using a transducer, use the effective value calculation type which is immune to harmonics.

7.2.5 Measurement of inverter input power factor

Calculate using effective power and apparent power. A power-factor meter can not indicate an exact value.

$$\begin{aligned} \text{Total power factor of the inverter} &= \frac{\text{Effective power}}{\text{Apparent power}} \\ &= \frac{\text{3-phase input power found by 3-wattmeter method}}{\sqrt{3} \times V (\text{power supply voltage}) \times I (\text{input current effective value})} \end{aligned}$$

7.2.6 Measurement of converter output voltage (across terminals P/+ and N/-)

The output voltage of the converter is developed across terminals P/+ and N/- and can be measured with a moving-coil type meter (tester). Although the voltage varies according to the power supply voltage, approximately 270VDC to 300VDC (540VDC to 600VDC for the 400V class) is output when no load is connected and voltage decreases during driving load operation.

When energy is regenerated from the motor during deceleration, for example, the converter output voltage rises to nearly 400VDC to 450VDC (800VDC to 900VDC for the 400V class) maximum.

7.2.7 Insulation resistance test using megger

- For the inverter, conduct the insulation resistance test on the main circuit only as shown below and do not perform the test on the control circuit. (Use a 500VDC megger.)

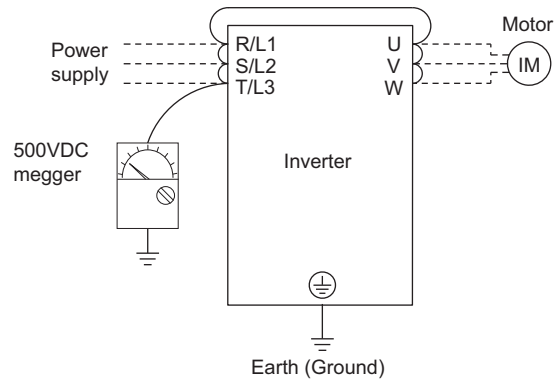

NOTE

- Before performing the insulation resistance test on the external circuit, disconnect the cables from all terminals of the inverter so that the test voltage is not applied to the inverter.
- For the electric continuity test of the control circuit, use a tester (high resistance range) and do not use the megger or buzzer.

7.2.8 Pressure test

Do not conduct a pressure test. Deterioration may occur.

MEMO

8 SPECIFICATIONS

This chapter provides the "SPECIFICATIONS" of this product.
Always read the instructions before using the equipment.

8.1	Rating.....	266
8.2	Common specifications	268
8.3	Outline dimension drawings.....	269

1

2

3

4

5

6

7

8

8.1 Rating

● Three-phase 200V power supply

Model FR-E720-□KNC		0.1	0.2	0.4	0.75	1.5	2.2	3.7	5.5	7.5	11	15
Applicable motor capacity (kW) *1		0.1	0.2	0.4	0.75	1.5	2.2	3.7	5.5	7.5	11	15
Output	Rated capacity (kVA) *2	0.3	0.6	1.2	2.0	3.2	4.4	7.0	9.5	13.1	18.7	23.9
	Rated current (A) *7	0.8 (0.8)	1.5 (1.4)	3 (2.5)	5 (4.1)	8 (7)	11 (10)	17.5 (16.5)	24 (23)	33 (31)	47 (44)	60 (57)
	Overload current rating *3	150% 60s, 200% 3s (inverse-time characteristics)										
	Rated voltage *4	Three-phase 200 to 240V										
	Regenerative braking torque *5	150%			100%		50%		20%			
Power supply	Rated input AC (DC) voltage/frequency	Three-phase 200 to 240V 50Hz/60Hz (283 to 339VDC *8)										
	Permissible AC (DC) voltage fluctuation	170 to 264V 50Hz/60Hz (240 to 373VDC *8)										
	Permissible frequency fluctuation	±5%										
	Power supply capacity (kVA) *6	0.4	0.8	1.5	2.5	4.5	5.5	9	12	17	20	28
Protective structure (JEM1030)		Open type (IP00)										
Cooling system		Self-cooling					Forced air cooling					
Approximate mass (kg)		0.5	0.5	0.7	1.0	1.4	1.4	1.7	4.3	4.3	6.5	6.5

● Three-phase 400V power supply

Model FR-E740-□KNC		0.4	0.75	1.5	2.2	3.7	5.5	7.5	11	15	
Applicable motor capacity (kW)*1		0.4	0.75	1.5	2.2	3.7	5.5	7.5	11	15	
Output	Rated capacity (kVA)*2	1.2	2.0	3.0	4.6	7.2	9.1	13.0	17.5	23.0	
	Rated current (A)*7	1.6 (1.4)	2.6 (2.2)	4.0 (3.8)	6.0 (5.4)	9.5 (8.7)	12	17	23	30	
	Overload current rating*3	150% 60s, 200% 3s (inverse-time characteristics)									
	Rated voltage*4	Three-phase 380 to 480V									
	Regenerative braking torque *5	100%			50%		20%				
Power supply	Rated input voltage/frequency	Three-phase 380 to 480V 50Hz/60Hz									
	Permissible AC voltage fluctuation	325 to 528V 50Hz/60Hz									
	Permissible frequency fluctuation	±5%									
	Power supply capacity (kVA)*6	1.5	2.5	4.5	5.5	9.5	12	17	20	28	
Protective structure (JEM1030)		Open type (IP00)									
Cooling system		Self-cooling				Forced air cooling					
Approximate mass (kg)		1.4	1.4	1.9	1.9	1.9	3.2	3.2	6.0	6.0	

*1 The applicable motor capacity indicated is the maximum capacity applicable for use of the Mitsubishi 4-pole standard motor.

*2 The rated output capacity indicated assumes that the output voltage is 230V for three-phase 200V class and 440V for three-phase 400V class.

*3 The % value of the overload current rating indicated is the ratio of the overload current to the inverter's rated output current. For repeated duty, allow time for the inverter and motor to return to or below the temperatures under 100% load.

*4 The maximum output voltage does not exceed the power supply voltage. The maximum output voltage can be changed within the setting range. However, the pulse voltage value of the inverter output side voltage remains unchanged at about $\sqrt{2}$ that of the power supply.

*5 The braking torque indicated is a short-duration average torque (which varies with motor loss) when the motor alone is decelerated from 60Hz in the shortest time and is not a continuous regenerative torque. When the motor is decelerated from the frequency higher than the base frequency, the average deceleration torque will reduce. Since the inverter does not contain a brake resistor, use the optional brake resistor when regenerative energy is large. (Option brake resistor cannot be used for 0.1K and 0.2K.) A brake unit (FR-BU2) may also be used.

*6 The power supply capacity varies with the value of the power supply side inverter impedance (including those of the input reactor and cables).

*7 Setting 2kHz or more in Pr. 72 PWM frequency selection to perform low acoustic noise operation in the surrounding air temperature exceeding 40°C (totally-enclosed structure is 30°C), the rated output current is the value in parentheses.

*8

- Connect DC power supply to terminal P/+ and N/-. Connect the plus side of the power supply to terminal P/+ and minus side to terminal N/-.
- Since the voltage between P/+ and N/- may increase due to the regeneration energy from the motor and exceeds 415V temporarily, select the DC power supply which can withstand the voltage/energy during regeneration. If using the power supply which can not withstand voltage/energy during regeneration, insert diodes in series for reverse current prevention.
- Although the FR-E700 series has the built-in inrush current limit circuit, select the DC power supply considering the inrush current at powering ON as the inrush current four times of the rated inverter flows at powering ON.
- Since the power supply capacity depends on the output impedance of the power, select the power supply capacity which has enough allowance according to the AC power supply system capacity.

● Single-phase 200V power supply

Model FR-E720S-□KNC		0.1	0.2	0.4	0.75	1.5	2.2
Applicable motor capacity (kW)*1		0.1	0.2	0.4	0.75	1.5	2.2
Output	Rated capacity (kVA)*2	0.3	0.6	1.2	2.0	3.2	4.4
	Rated current (A)*7	0.8 (0.8)	1.5 (1.4)	3.0 (2.5)	5.0 (4.1)	8.0 (7.0)	11.0 (10.0)
	Overload current rating*3	150% 60s, 200% 3s (inverse-time characteristics)					
	Rated voltage*4	Three-phase 200 to 240V					
	Regenerative braking torque *5	150%		100%		50%	20%
Power supply	Rated input AC voltage/frequency	Single-phase 200 to 240V 50Hz/60Hz					
	Permissible AC voltage fluctuation	170 to 264V 50Hz/60Hz					
	Permissible frequency fluctuation	Within ±5%					
	Power supply capacity (kVA)*6	0.5	0.9	1.5	2.5	4.0	5.2
Protective structure (JEM1030)		Open type (IP00)					
Cooling system		Self-cooling			Forced air cooling		
Approximate mass (kg)		0.6	0.6	0.9	1.4	1.5	2.0

- *1 The applicable motor capacity indicated is the maximum capacity applicable for use of the Mitsubishi 4-pole standard motor.
- *2 The rated output capacity indicated assumes that the output voltage is 230V.
- *3 The % value of the overload current rating indicated is the ratio of the overload current to the inverter's rated output current. For repeated duty, allow time for the inverter and motor to return to or below the temperatures under 100% load. If the automatic restart after instantaneous power failure function (*Pr. 57*) or power failure stop function (*Pr. 261*) is set and power supply voltage is low while load becomes bigger, the bus voltage decreases to power failure detection level and load of 100% or more may not be available.
- *4 The maximum output voltage does not exceed the power supply voltage. The maximum output voltage can be changed within the setting range. However, the pulse voltage value of the inverter output side voltage remains unchanged at about $\sqrt{2}$ that of the power supply.
- *5 The braking torque indicated is a short-duration average torque (which varies with motor loss) when the motor alone is decelerated from 60Hz in the shortest time and is not a continuous regenerative torque. When the motor is decelerated from the frequency higher than the base frequency, the average deceleration torque will reduce. Since the inverter does not contain a brake resistor, use the optional brake resistor when regenerative energy is large. (Option brake resistor cannot be used for 0.1K and 0.2K.) A brake unit (FR-BU2) may also be used.
- *6 The power supply capacity varies with the value of the power supply side inverter impedance (including those of the input reactor and cables).
- *7 Setting 2kHz or more in *Pr. 72 PWM frequency selection* to perform low acoustic noise operation with the surrounding air temperature exceeding 40°C, the rated output current is the value in parentheses.

8.2 Common specifications

Control specifications	Control method	Soft-PWM control/high carrier frequency PWM control (V/F control, Advanced magnetic flux vector control, General-purpose magnetic flux vector control, Optimum excitation control are available)
	Output frequency range	0.2 to 400Hz
	Frequency setting resolution (Digital input)	0.01Hz
	Frequency accuracy (Digital input)	Within 0.01% of the set output frequency
	Voltage/frequency characteristics	Base frequency can be set from 0 to 400Hz, constant-torque/variable-torque pattern can be selected
	Starting torque	200% or more (at 0.5Hz)...when Advanced magnetic flux vector control is set (3.7K or lower)
	Torque boost	Manual torque boost
	Acceleration/deceleration time setting	0.01 to 360s, 0.1 to 3600s (acceleration and deceleration can be set individually), linear or S-pattern acceleration/deceleration modes are available.
	DC injection brake	Operation frequency (0 to 120Hz), operation time (0 to 10s), operation voltage (0 to 30%) can be changed.
Stall prevention operation level	Operation current level can be set (0 to 200% adjustable), whether to use the function or not can be selected.	
Operation specifications	Frequency setting signal (Digital input)	The signal can be input from the operation panel or via CC-Link communication. Frequency setting increment can be set.
	Start signal	Forward and reverse rotation can be selected.
	Input signal (assigned to the input virtual terminals of CC-Link communication)	The following signals can be assigned to Pr.180 to Pr.184 (input terminal function selection): multi-speed selection, remote setting, stop-on contact selection, second function selection, PID control valid terminal, brake opening completion signal, V/F switchover, output stop
	Operational functions	Maximum/minimum frequency setting, frequency jump operation, automatic restart after instantaneous power failure operation, forward/reverse rotation prevention, remote setting, brake sequence, second function, multi-speed operation, stop-on contact control, droop control, regeneration avoidance, slip compensation, operation mode selection, offline auto tuning function, PID control
	Safety stop function	Safety shutoff signal can be input from terminals S1 and S2. (compliant with EN ISO 13849-1 Category 3 / PLd EN62061 / IEC61508 SIL2)
	Output signal Open collector output (One terminal)	The following signals can be assigned to Pr.190 to Pr.192, Pr.313 to Pr.315 (output terminal function selection): inverter running, up-to-frequency, overload alarm, output frequency detection, regenerative brake prealarm, electronic thermal relay function prealarm, inverter operation ready, output current detection, zero current detection, PID lower limit, PID upper limit, PID forward/reverse rotation output, brake opening request, fan alarm*2, heatsink overheat pre-alarm, deceleration at an instantaneous power failure, PID control activated, during retry, life alarm, current average value monitor, remote output, alarm output, fault output, fault output 3, maintenance timer alarm, safety monitor output, safety monitor output2.
Operation panel indication	Operating status	The following operating statuses can be displayed: output frequency, motor current (steady), output voltage, frequency setting, cumulative energization time, actual operation time, motor torque, converter output voltage, regenerative brake duty, electronic thermal relay function load factor, output current peak value, converter output voltage peak value, motor load factor, PID set point, PID measured value, PID deviation, output power, cumulative power, motor thermal load factor, and inverter thermal load factor.
	Fault record	Fault record is displayed when a fault occurs. Past 8 fault records (output voltage/current/frequency/cumulative energization time right before the fault occurs) are stored.
Protective/warning function	Protective functions	Overcurrent during acceleration, overcurrent during constant speed, overcurrent during deceleration, overvoltage during acceleration, overvoltage during constant speed, overvoltage during deceleration, inverter protection thermal operation, motor protection thermal operation, heatsink overheat, input phase failure*5, stall prevention stop, output side earth (ground) fault overcurrent at start*4, output phase failure, option fault, parameter error, retry count excess *4, CPU fault, brake transistor alarm, inrush resistance overheat, communication error, USB communication fault, brake sequence error 4 to 7 *4, safety circuit fault
	Warning functions	Fan alarm*2, overcurrent stall prevention, overvoltage stall prevention, PU stop, parameter write error, regenerative brake prealarm *4, electronic thermal relay function prealarm, maintenance output *4, undervoltage, operation panel lock, password locked*4, inverter reset, safety stop, 24V external power supply operation
Environment	Surrounding air temperature	-10°C to +50°C (non-freezing) *3
	Ambient humidity	90%RH or less (non-condensing)
	Storage temperature*1	-20°C to +65°C
	Atmosphere	Indoors (without corrosive gas, flammable gas, oil mist, dust and dirt etc.)
	Altitude/vibration	Maximum 1000m above sea level, 5.9m/s ² or less at 10 to 55Hz (directions of X, Y, Z axes)

*1 Temperatures applicable for a short time, e.g. in transit.

*2 As the FR-E720-0.1KNC to 0.75KNC, FR-E740-0.4KNC and 0.75KNC, FR-E720S-0.1KNC to 0.4KNC are not provided with the cooling fan, this alarm is not available.

*3 When using the inverters at the surrounding air temperature of 40°C or less, the inverters can be installed closely attached (0cm clearance).

*4 This protective function is not available in the initial status.

*5 This protective function is available with the three-phase power input model only.

8.3 Outline dimension drawings

- FR-E720-0.1KNC to 0.75KNC
- FR-E720S-0.1KNC to 0.4KNC

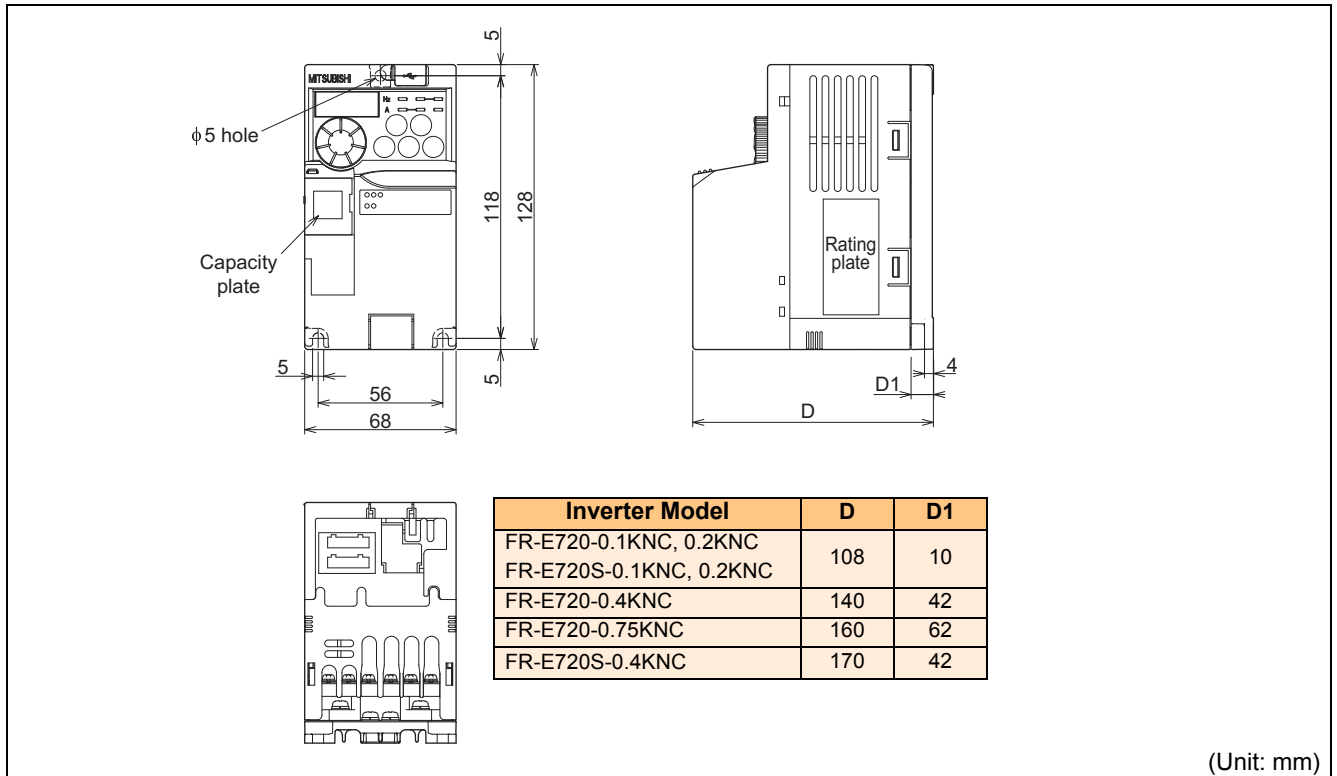

- FR-E720-1.5KNC, 2.2KNC
- FR-E720S-0.75KNC, 1.5KNC

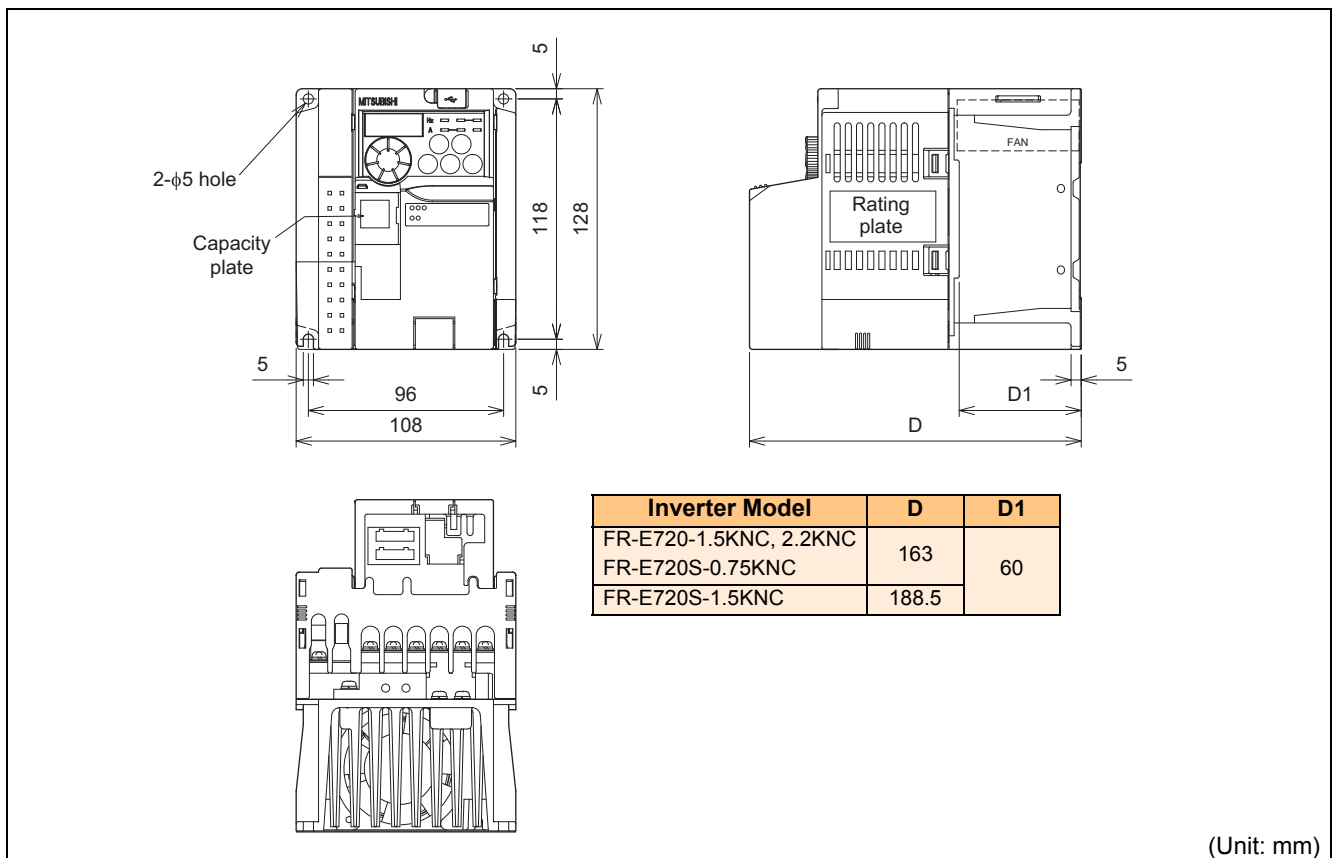

Outline dimension drawings

●FR-E720-3.7KNC

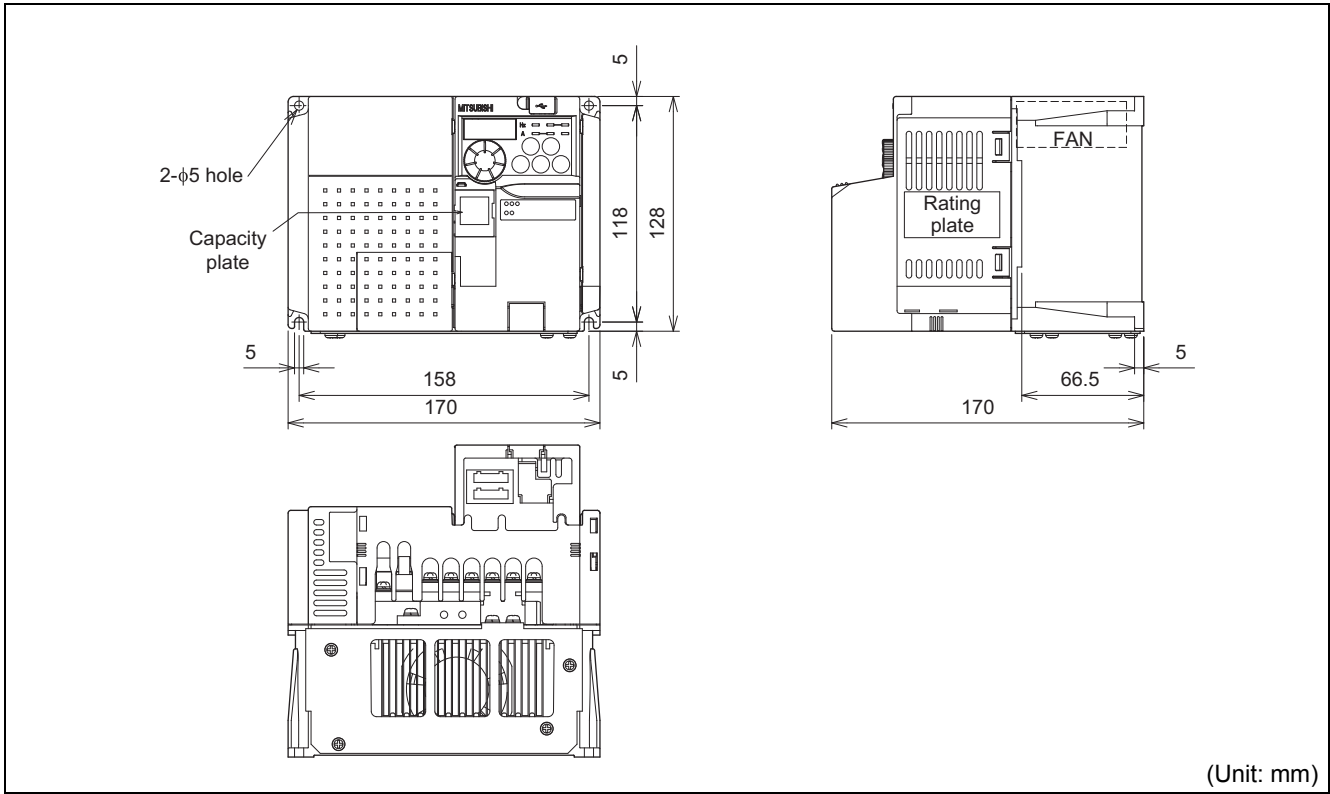

●FR-E720-5.5KNC to 15KNC

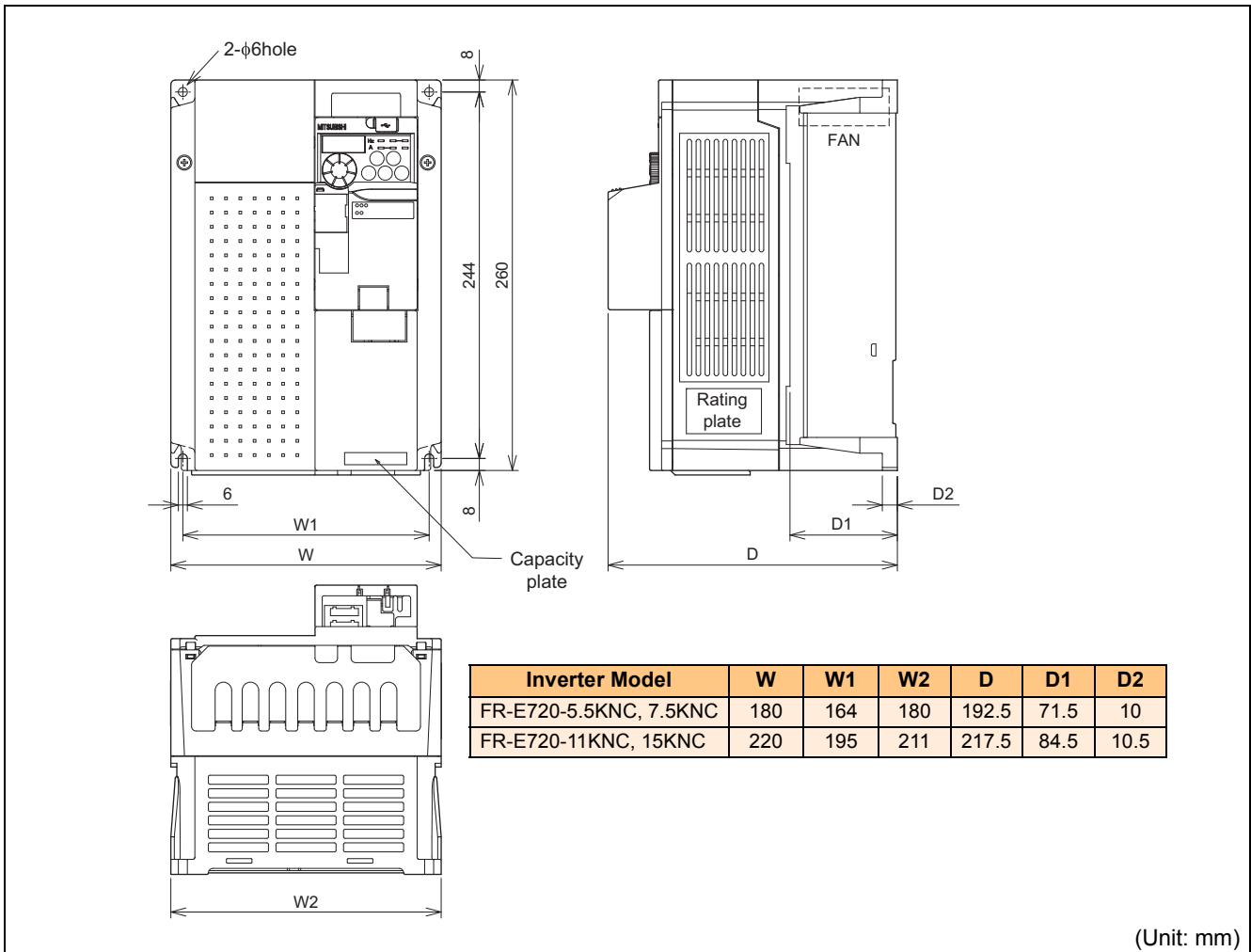

- FR-E740-0.4KNC to 3.7KNC
- FR-E720S-2.2KNC

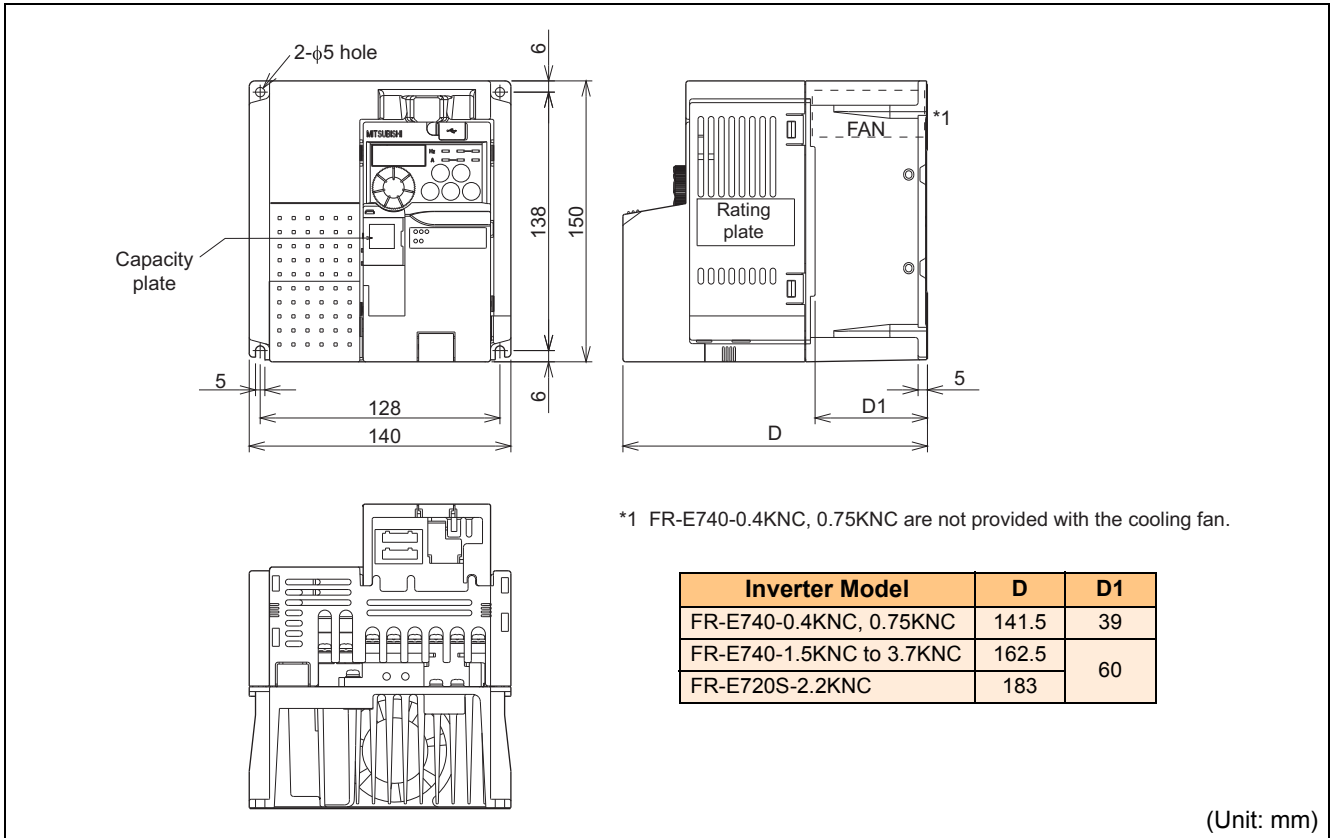

- FR-E740-5.5KNC, 7.5KNC

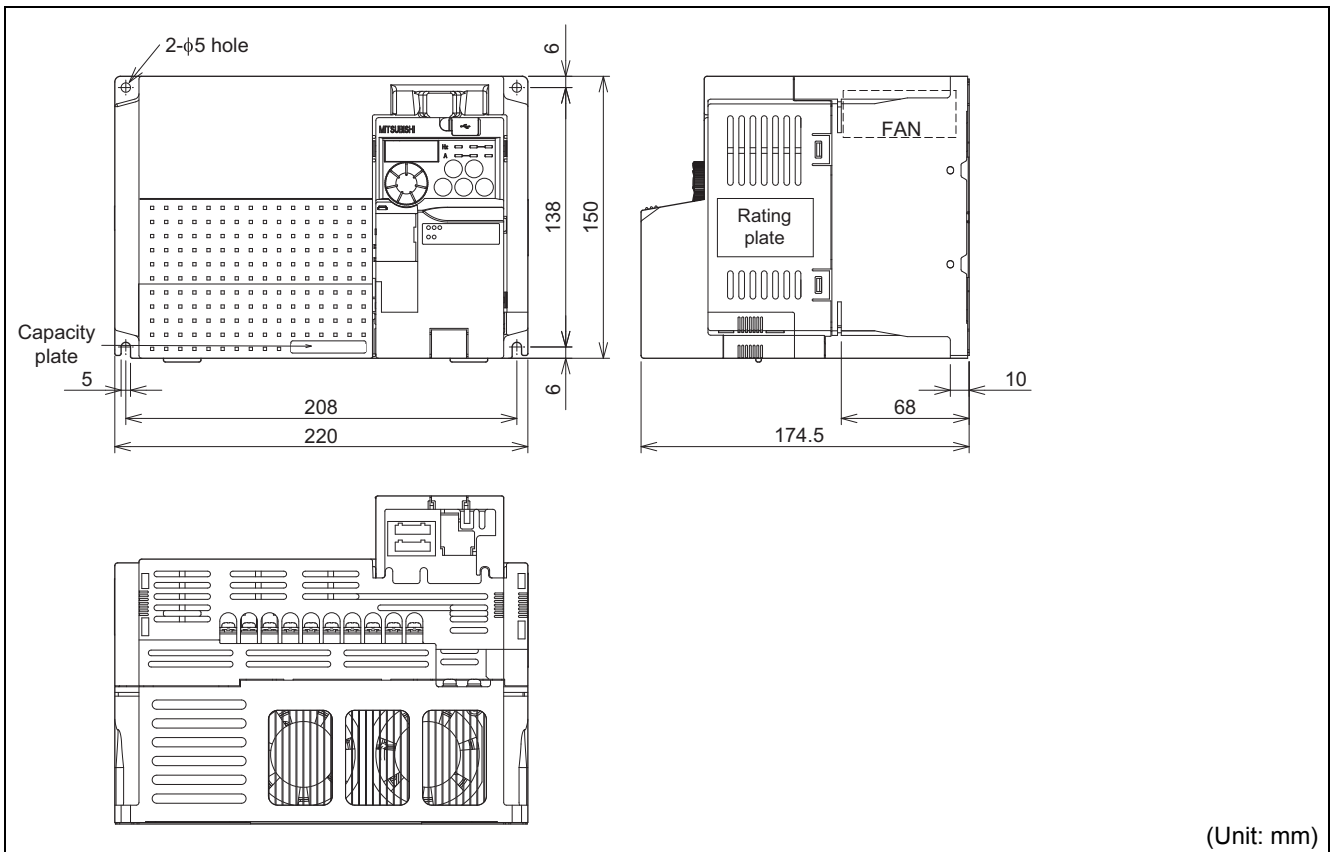

●FR-E740-11KNC, 15KNC

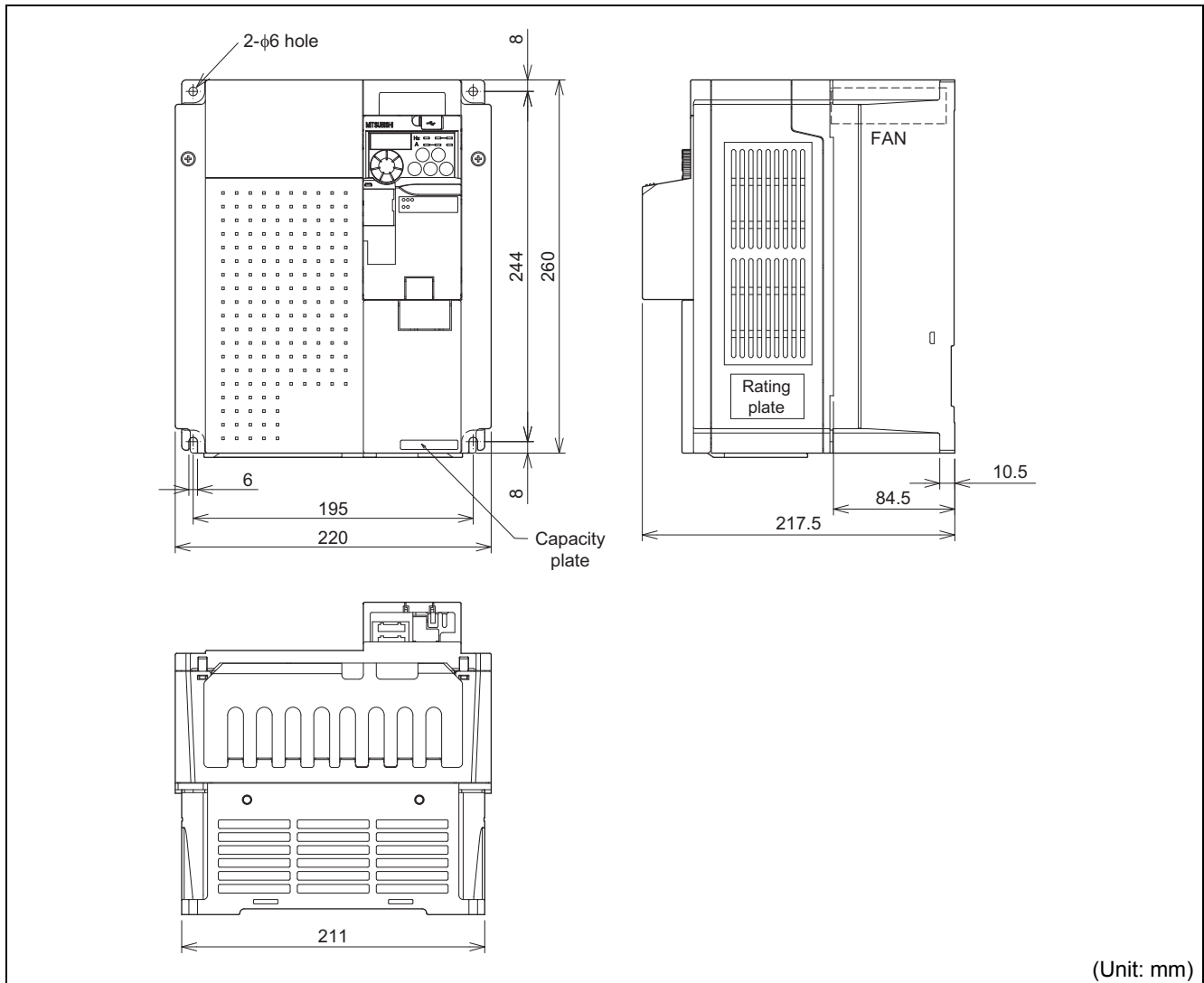

(Unit: mm)

A large, stylized number '3' graphic. The top horizontal bar is light green with a dark green outline. The vertical stem is dark green. The bottom horizontal bar is light green with a dark green outline. The word 'APPENDIX' is centered to the right of the stem.

APPENDIX

**This chapter provides the "APPENDIX" of this product.
Always read the instructions before using the equipment.**

Appendix 1 Main differences with the FR-E500(N) CC-Link model

Item		FR-E500 (N)	FR-E700 (NC)
Control method		V/F control General-purpose magnetic flux vector control	V/F control General-purpose magnetic flux vector control Advanced magnetic flux vector control Optimum excitation control
CC-Link specification	Shape	Terminal block connection (removable from the inverter front)	Two one-touch connectors dedicated to CC-Link communication
	Connectable units	Up to 42 units (one unit occupies one station). Other models can also be used.	Up to 42 units. (Refer to page 105 for the number of occupied stations). Other models can also be used.
	Station type	Remote device station	
	Number of occupied stations	One inverter occupies one station.	CC-Link Ver. 1: Occupies one station. CC-Link Ver. 2: Occupies one station (double, quadruple, and octuple settings are selectable). (Pr. 544)
	Connection cable	CC-Link dedicated cable, CC-Link Ver. 1.10 compatible CC-Link dedicated cable	
	Station number setting	Set with the rotary switch	Set with the parameter (Pr. 542)
	Transmission baud rate setting	Set with the rotary switch	Set with the parameter (Pr. 543)
	Communication by the 24V external power supply	Not available	Available
Changed/cleared functions	Torque boost (Pr. 0) initial value FR-E520-1.5KNC to 7.5KNC: 6%		FR-E720-1.5KNC to 3.7KNC: 4% FR-E720-5.5KNC, 7.5KNC: 3%
	DC injection brake operation voltage (Pr. 12) initial value 0.4K to 7.5K: 6%		0.4K to 7.5K: 4%
	Second electronic thermal O/L relay (Pr. 48) Shortest acceleration/ deceleration mode (Pr. 60)		Parameter numbers changed (Pr. 51 Second electronic thermal O/L relay) (Pr. 60 Energy saving control selection) (Pr. 292 Automatic acceleration/deceleration)
	Second applied motor Pr. 71 = 100 to 123		Pr. 450 Second applied motor
	Operation mode selection (Pr. 79) Initial value 2: CC-Link operation mode Setting range: 0 to 2		Initial value 0: CC-Link operation mode is selected at power ON Setting range: 0 to 4,6,7
	Setting General-purpose magnetic flux vector Pr. 80 ≠ 9999		Pr. 80 ≠ 9999, Pr. 81 ≠ 9999, Pr. 800 = 30
	User group 1 (16), user group 2 (16) (Pr. 160, Pr. 173 to Pr. 175)		User group (16) only, setting methods were partially changed (Pr. 160, Pr. 172, Pr. 173)
	Input terminal function selection (Pr. 180 to Pr. 183) setting 6: MRS signal (output stop)		Pr. 180 to Pr. 184 Input terminal function selection setting 6: None 24: MRS signal (output stop)
	Cooling fan operation selection (Pr. 244) initial setting 0: Cooling fan operates in power-on status.		1: Cooling fan on/off control valid
	Stop selection (Pr. 250) setting increments 1s		0.1s
Inrush current limit circuit		Provided for the 2.2K or higher	Provided for the all capacity
Control terminals	Terminal block specification	Fixed terminal block (cannot be removed) Screw type terminal block (Phillips screw M2.5) Length of recommended blade terminal is 7mm	Removable terminal block Spring clamp terminal block (The spring pressure inside locks the wire.) Length of recommended blade terminal is 10mm
	Input terminal	MRS (can be assigned), RES (can be assigned)	S1 and S2 (cannot be assigned)
	Output terminal	ABC (can be assigned), relay output	Y0 (can be assigned), open collector output
Operation panel		Not available	Integrated operation panel (can not be removed)
Parameter unit		FR-PU04	Cannot be used
RS-485 communication		Available	Not available
Option unit		FR-HC and FR-CV are connectable.	FR-HC and FR-CV are not connectable (because FR-E700-NC do not have the terminal MRS.)
Installation size		Installation size is compatible	

Appendix 2 Specification change

Appendix 2-1 SERIAL number check

Check the SERIAL number indicated on the inverter rating plate or package. (Refer to page 2)

Rating plate example

□ ○ ○ ○○○○○○
Symbol Year Month Control number
SERIAL (Serial No.)

The SERIAL consists of one symbol, two characters indicating production year and month, and six characters indicating control number.

Last digit of the production year is indicated as the Year, and the Month is indicated by 1 to 9, X (October), Y (November), and Z (December).

Appendix 2-2 Changed functions

(1) Operating conditions for the SAFE signal and SAFE2 signal

This change applies to the inverters having the following SERIAL or later. (Refer to page 24.)

Type	SERIAL (Serial No.)
FR-E720-0.1KNC to 15KNC	D0○○○○○○○
FR-E740-0.4KNC to 15KNC	A0○○○○○○○
FR-E720S-0.1KNC to 2.2KNC	A0○○○○○○○

- The operating conditions (E.6, E.7, and E.CPU) are added for the SAFE signal and SAFE2 signal, which are used in the safety stop function.

Appendix 3 Index

Numerics

- 15-speed selection (combination with three speeds RL, RM, RH)(REX signal).....130, 163
- 24V external power supply operation (EV signal).....23, 167
- 24V external power supply operation (EV).....23, 237

A

- Acceleration time, deceleration time setting (Pr. 7, Pr. 8, Pr. 20, Pr. 21, Pr. 44, Pr. 45).....135
- Acceleration/deceleration pattern (Pr. 29).....139
- Actual Operation Time.....176
- Advanced magnetic flux control (Pr. 71, Pr. 80, Pr. 81, Pr. 89, Pr. 800).....114
- Alarm output (LF signal).....167, 213
- Applied motor (Pr. 71, Pr. 450).....144
- Automatic restart after instantaneous power failure/flying start (Pr. 57, Pr. 58, Pr. 96, Pr. 162, Pr. 165, Pr. 298, Pr. 299, Pr. 611).....180
- Avoid mechanical resonance points (frequency jumps)(Pr. 31 to Pr. 36).....125

B

- Base frequency, voltage (Pr. 3, Pr. 19, Pr. 47).....126
- Basic operation (factory setting).....81
- Brake opening completion signal (BRI signal).....160, 163
- Brake opening request (BOF signal).....160, 167
- Brake sequence fault (E.MB4 to 7).....160, 242
- Brake sequence function (Pr. 278 to Pr. 283, Pr. 292).....160
- Brake transistor alarm detection (E.BE).....240

C

- Cables and wiring length.....17
- CC-Link communication reset selection (Pr.349).....110
- CC-Link communication setting (Pr.541 to Pr.544).....105
- CC-Link communication specifications.....48
- CC-Link Ver. 1.10.....48
- CC-Link Ver. 2.....48
- Change the control method (Pr. 80, Pr. 81, Pr. 800).....112
- Change the parameter setting value.....82
- Checking the inverter and converter modules.....254
- Cleaning.....255
- Communication EEPROM write selection (Pr. 342).....110
- Communication option fault (E.OP1).....240
- Communication stops during operation.....77
- Connecting the 24V external power supply.....23
- Connection cable and plug.....51
- Connection of a dedicated external brake resistor (MRS type, MYS type, FR-ABR) (0.4K or higher).....26
- Connection of CC-Link dedicated cable.....52
- Connection of several inverters.....50
- Connection of the brake unit (FR-BU2).....28
- Connection of the DC reactor (FR-HEL).....29
- Control circuit terminal.....20
- Converter output voltage.....176
- Converter output voltage peak value.....176
- Cooling fan operation selection (Pr. 244).....213
- Cooling system types for inverter panel.....10
- CPU error (E. 5, E. 6, E. 7, E.CPU).....241

- Cumulative energization time.....176
- Cumulative power.....176
- Cumulative power 2.....176
- Current average value monitor signal (Pr. 555 to Pr. 557)218
- Current average value monitor signal (Y93 signal)....167, 218

D

- Daily and periodic inspection.....253
- Daily inspection.....252
- DC injection brake (Pr. 10 to Pr. 12).....154
- Details of remote input and output signals.....60
- Details of remote register.....62
- Detection of output frequency (SU, FU signal, Pr. 41 to Pr. 43).....171
- Display of the life of the inverter parts (Pr. 255 to Pr. 259).....214, 254
- Droop control (Pr. 286, Pr. 287).....210
- During PID control activated (PID signal).....167, 203
- During retry (Y64 signal).....167, 188

E

- Earth (ground) fault detection at start (Pr. 249).....190
- Electronic thermal O/L relay pre-alarm (TH).....142, 236
- Electronic thermal O/L relay pre-alarm (THP signal)..142, 167
- Electronic Thermal Relay Function Load Factor.....176
- Extended parameter display and user group function (Pr. 160, Pr. 172 to Pr. 174).....197

F

- Fan alarm (FN).....213, 237
- Fan fault output (FAN signal).....167, 213
- Fault or alarm indication.....176, 229
- Fault output (ALM signal).....167, 170
- Fault output 3 (power-OFF signal) (Y91 signal).....167, 170
- Faults history (E.---).....229
- Fin overheat (E.FIN).....239
- Forward rotation signal (STF signal).....165
- Free parameter (Pr. 888, Pr. 889).....222
- Frequency setting value.....176
- Front cover.....5
- Function block diagram.....54

G

- General-purpose magnetic flux vector control (Pr. 71, Pr. 80, Pr. 81, Pr. 800).....117

H

- Harmonic suppression guideline in Japan.....37
- Heatsink overheat pre-alarm (FIN signal).....167, 239
- High speed operation command (RH signal).....130, 163

I

- I/O signal when CC-Link Ver.1 one station (FR-E500 series compatible) is occupied (Pr. 544 = 0).....56
- I/O signal when CC-Link Ver.1 one station is occupied (Pr. 544 = "1").....57
- I/O signal when CC-Link Ver.2 double setting is selected (Pr. 544 = "12").....57
- I/O signal when CC-Link Ver.2 octuple setting is selected (Pr.

544 = "18").....	59
I/O signal when CC-Link Ver.2 quadruple setting is selected (Pr. 544 = "14").....	58
Input phase loss (E.ILF).....	190, 239
Input terminal function selection (Pr. 180 to Pr. 184).....	163
Input to the inverter from the network.....	55
Input/output phase loss protection selection (Pr. 251, Pr. 872).....	190
Inrush current limit circuit fault (E.IOH).....	242
Instructions.....	74
Insulation resistance test using megger.....	263
Internal board fault (E.PE2).....	241
Internal circuit fault (E.13).....	242
Inverter I/O Terminal Monitor.....	176, 178
Inverter installation environment.....	8
Inverter operation ready (RY signal).....	167, 169
Inverter output shutoff signal (MRS signal, Pr. 17).....	166
Inverter overload trip (electronic thermal relay function) (E.THT).....	142, 239
Inverter placement.....	11
Inverter reset (Err.).....	232, 234
Inverter running (RUN signal).....	167, 169
Inverter thermal load factor.....	176
Inverter-generated noises and their reduction techniques..	34
J	
JOG operation (Pr. 15, Pr. 16).....	201
L	
Leakage currents and countermeasures.....	32
Life alarm (Y90 signal).....	167, 214
Load pattern selection (Pr. 14).....	128
Low-speed operation command (RL signal).....	130, 163
M	
Magnitude of frequency change setting (Pr. 295).....	226
Maintenance signal output (MT).....	217, 236
Maintenance timer alarm (Pr. 503, Pr. 504).....	217
Maintenance timer signal (Y95 signal).....	167, 217
Manual torque boost (Pr. 0, Pr. 46).....	113
Maximum/minimum frequency (Pr. 1, Pr. 2, Pr. 18).....	124
Measurement of converter output voltage (across terminals P/+ and N/-).....	262
Measurement of currents.....	262
Measurement of inverter input power factor.....	262
Measurement of powers.....	261
Measurement of voltages and use of PT.....	261
Middle-speed operation command (RM signal).....	130, 163
Monitor display selection of operation panel (Pr. 52, Pr. 170, Pr. 171, Pr. 268, Pr. 563, Pr. 564).....	176
Motor Load Factor.....	176
Motor overheat protection (Electronic thermal O/L relay) (Pr. 9, Pr. 51).....	142
Motor overload trip (electronic thermal relay function) (E.THM).....	142, 239
Motor thermal load factor.....	176
Motor Torque.....	176
N	
Names and functions of the operation panel.....	80

O	
Operation by multi-speed operation (Pr. 4 to Pr. 6, Pr. 24 to Pr. 27, Pr. 232 to Pr. 239).....	130
Operation mode selection (Pr. 79).....	103
Operation panel frequency setting/key lock operation selection (Pr. 161).....	224
Operation panel lock (HOLD).....	224, 234
Operation selection at CC-Link communication error occurrence (Pr. 500 to Pr. 502).....	107
Operation status indication LED.....	75
Optimum excitation control (Pr. 60).....	191
Option fault (E.1).....	241
Option fault (E.OPT).....	241
Output current.....	176
Output current detection (Y12 signal).....	167, 172
Output current detection function (Y12 signal, Y13 signal, Pr. 150 to Pr. 153).....	172
Output Current Peak Value.....	176
Output frequency.....	176
Output frequency detection (FU signal).....	167, 171
Output from the inverter to the network.....	55
Output phase loss (E.LF).....	190, 240
Output power.....	176
Output side earth (ground) fault overcurrent at start (E.GF).....	190, 240
Output stop (MRS signal).....	163, 166
Output terminal function selection (Pr. 190 to Pr. 192, Pr. 313 to Pr. 315).....	167
Output voltage.....	176
Overcurrent trip during acceleration (E.OC1).....	237
Overcurrent trip during constant speed (E.OC2).....	237
Overcurrent trip during deceleration or stop (E.OC3).....	238
Overload alarm (OL signal).....	120, 167
P	
Parameter list.....	84
Parameter storage device fault (control circuit board) (E.PE).....	241
Parameter write disable selection (Pr. 77).....	196
Parameter write error (Er1, Er.2, Er4).....	234
Password function (Pr. 296, Pr. 297).....	199
Password locked (LOCd).....	234
Periodic inspection.....	252
Peripheral devices.....	4
PID control (Pr. 125, Pr. 127 to Pr. 132, Pr. 134, C2).....	203
PID control valid terminal (X14 signal).....	163, 203
PID Deviation.....	176, 203
PID Forward/Reverse Rotation Output (RL signal).....	167, 203
PID lower limit (FDN signal).....	167, 203
PID Measured Value.....	176, 203
PID Set Point.....	176, 203
PID upper limit (FUP signal).....	167, 203
Power failure deceleration signal (Y46 signal).....	167, 186
Power supply harmonics.....	36
Power-failure deceleration stop function (Pr. 261).....	186
Pressure test.....	263
Program example for fault record reading.....	73
Program example for monitoring the output frequency.....	70
Program example for parameter reading.....	71
Program example for parameter writing.....	71

Program example for reading the inverter status	69
Program example for resetting the inverter at inverter error	73
Program example for setting the operation commands	70
Program example for setting the operation mode	69
Program example for setting the running frequency	72
PU stop (PS)	194, 235
PWM carrier frequency and soft-PWM control (Pr. 72, Pr. 240)	192

R

Regeneration avoidance function (Pr. 665, Pr. 882, Pr. 883, Pr. 885, Pr. 886)	211
Regenerative brake duty	155, 176
Regenerative brake prealarm (RB)	155, 236
Regenerative brake prealarm (RBP signal)	155, 167
Regenerative overvoltage trip during acceleration (E.OV1)	211, 238
Regenerative overvoltage trip during constant speed (E.OV2)	211, 238
Regenerative overvoltage trip during deceleration or stop (E.OV3)	211, 238
Remote output (REM signal)	167, 174
Remote output selection (REM signal, Pr. 495, Pr. 496)	174
Remote setting (RH, RM, RL signal)	132, 163
Remote setting function (Pr. 59)	132
Replacement of parts	255
Reset selection/PU stop selection (Pr. 75)	194
Retry count excess (E.RET)	188, 241
Retry function (Pr. 65, Pr. 67 to Pr. 69)	188
Reverse rotation prevention selection (Pr. 78)	197
Reverse rotation signal (STR signal)	165
RUN key rotation direction selection (Pr. 40)	223

S

Safety circuit fault (E.SAF)	24, 242
Safety monitor output	167
Safety monitor output 2	167
Safety stop (SA)	24, 236
Safety stop function	24
Second function selection (RT signal)	163, 165
Selection of a regenerative brake (Pr. 30, Pr. 70)	155
Setting dial push	83
Shortest acceleration/deceleration (automatic acceleration/ deceleration) (Pr. 61 to Pr. 63, Pr. 292, Pr. 293)	140
Slip compensation (Pr. 245 to Pr. 247)	119
Specification of main circuit terminal	15
Speed display and speed setting (Pr. 37)	175
Speed smoothing control (Pr. 653)	193
Stall prevention (E.OLT)	120, 240
Stall prevention (overcurrent) (OL)	120, 235
Stall prevention (overvoltage) (oL)	211, 235
Stall prevention operation (Pr. 22, Pr. 23, Pr. 48, Pr. 66, Pr. 156, Pr. 157, Pr. 277)	120
Starting frequency and start-time hold function (Pr. 13, Pr. 571)	138
Stop selection (Pr. 250)	157
Stop-on contact control function (Pr. 6, Pr. 48, Pr. 270, Pr. 275, Pr. 276)	158
Stop-on contact selection 0 (RL signal)	158, 163
Stop-on contact selection 1 (RT signal)	158, 163

System configuration example	49
------------------------------------	----

T

Terminal arrangement of the main circuit terminal, power supply and the motor wiring	15
Terminal connection diagram	14
To exhibit the best performance of the motor performance (offline auto tuning) (Pr. 71, Pr. 80 to Pr. 84, Pr. 90 to Pr. 94, Pr. 96, Pr. 859)	146

U

Undervoltage (UV)	236
Unit replacement while online	53
Up-to-frequency signal (SU signal)	167, 171
USB communication (Pr. 547, Pr. 548, Pr. 551)	220
USB communication fault (E.USB)	220, 242
Use of CT and transducer	262

V

V/F switchover (V/F control is exercised when X18 is ON) (X18 signal)	112, 163
---	----------

W

When one inverter is connected	75
When two or more inverters are connected	76
Wiring cover	7
Wiring instructions	22
Wiring of control circuit	21

Z

Zero current detection (Y13 signal)	167, 172
---	----------

MEMO

REVISIONS

*The manual number is given on the bottom left of the back cover.

Print Date	*Manual Number	Revision
Nov. 2011	IB(NA)-0600402ENG-A	First edition

 **For Maximum Safety**

- Mitsubishi inverters are not designed or manufactured to be used in equipment or systems in situations that can affect or endanger human life.
- When considering this product for operation in special applications such as machinery or systems used in passenger transportation, medical, aerospace, atomic power, electric power, or submarine repeating applications, please contact your nearest Mitsubishi sales representative.
- Although this product was manufactured under conditions of strict quality control, you are strongly advised to install safety devices to prevent serious accidents when it is used in facilities where breakdowns of the product are likely to cause a serious accident.
- Please do not use this product for loads other than three-phase induction motors.

FR-E700-NC Series

Instruction Manual Supplement

1 For the terminating resistor selection switch





Please make corrections to the following error in this manual.

Connection of several inverters

- Instruction Manual (Basic) : page 17
- Instruction Manual (Applied): page 50

(Incorrect)





- *2 Set "1" and "2" of the terminating resistor selection switch (SW1) to OFF (without terminating resistor) in the middle units.

	1	2	Description
	OFF	OFF	Without terminating resistor (initial setting)
	ON	OFF	Do not use.
	OFF	ON	130Ω
	ON	ON	110Ω

130Ω is a resistance value for the CC-Link Ver. 1.00 dedicated high performance cable

(Correct)

- *2 Set "1" and "2" of the terminating resistor selection switch (SW1) to OFF (without terminating resistor) in the middle units.

	1	2	Description
	OFF	OFF	Without terminating resistor (initial setting)
	ON	OFF	130Ω
	OFF	ON	Do not use.
	ON	ON	110Ω

130Ω is a resistance value for the CC-Link Ver. 1.00 dedicated high performance cable

2 Additional notes for instructions for UL and cUL

- Instruction Manual (Basic) : page 43

General precaution

CAUTION - Risk of Electric Shock -

The bus capacitor discharge time is 10 minutes. Before starting wiring or inspection, switch power off, wait for more than 10 minutes.

ATTENTION - Risque de choc électrique -

La durée de décharge du condensateur de bus est de 10 minutes.

Avant de commencer le câblage ou l'inspection, mettez l'appareil hors tension et attendez plus de 10 minutes.

Motor overload protection

When using the electronic thermal relay function as motor overload protection, set the rated motor current to *Pr. 9 "Electronic thermal O/L relay"*.



NOTE

- Motor over temperature sensing is not provided by the drive.

mitsubishi electric corporation

HEAD OFFICE: TOKYO BUILDING 2-7-3, MARUNOUCHI, CHIYODA-KU, TOKYO 100-8310, JAPAN